

PLCC 2835 HE Series Datasheet



Features :

- Superior luminous efficiency 181 lm/W @4000K
- Deliver 33.5 lm @65mA, 4000K
- Pass LM-80 verification

Typical Applications :

- Down light
- Commercial lighting
- General lighting

Table of Contents

General Information.....	3
Absolute Maximum Ratings.....	4
Characteristics.....	4
Electro - Optical Characteristics (Neutral White).....	5
Luminous Flux Characteristic.....	6
Voltage Bin Structure.....	6
Mechanical Dimensions.....	7
Color BIN code.....	8
Characteristic curve.....	12
Reflow Profile.....	17
Reliability.....	18
Product Packaging Information.....	19
Revision History.....	20
About Edison Opto.....	20

General Information

Introduction

PLCC 2835 HE Series features ultra high luminous efficacy and compact package size which increase the flexibility in lamp design and expand the range of applications. With the outperforming efficiency, PLCC 2835 HE Series is optimized to be used in high-end LED market such as boutique and luxury apparel store.

Ordering Code Format

2
X1
T
X2
03
X3-X4
X8
X5-X6
xW
X7-X8
xx
X9-X10
000
X11-X13
xxx
X14-X16

X1		X2		X3-X4		X5-X6		X7-X8	
Type	Emitter	Component	PLCC	Series	3528	Wattage	0.8W	Color	
2	Emitter	T	PLCC	03	3528	X8	0.8W	CW	Cool White
								NW	Neutral White
								WW	Warm White

X9-X10		X11-X13		X14-X16	
Internal code		PCB Board		Serial Number	
-	-	000	-	-	-

Absolute Maximum Ratings

Absolute maximum ratings ($T_a=25^{\circ}\text{C}$)

Parameter	Symbol	Value	Units
DC Forward Current	I_F	200	mA
Pulse Forward Current ($t_p \leq 100\mu\text{s}$, Duty cycle=0.25)	I_{pulse}	350	mA
Reverse Current	I_R	10	μA
Reverse Voltage	V_R	5	V
LED Junction Temperature	T_J	125	$^{\circ}\text{C}$
Operating Temperature	-	-40 ~ +85	$^{\circ}\text{C}$
Storage Temperature	-	-40 ~ +125	$^{\circ}\text{C}$
ESD Sensitivity (HBM)	V_B	2,000	V
Soldering Temperature	T_s	Reflow Soldering : 255~260 $^{\circ}\text{C}$ /10~30sec Manual Soldering : 350 $^{\circ}\text{C}$ /3sec	

Notes:

1. Proper current derating must be observed to maintain junction temperature below the maximum at all time.
2. LEDs are not designed to be driven in reverse bias.

Characteristics

Parameter	Symbol	Value	Units	
Viewing Angle	(Typ.) $2\theta_{1/2}$	120	Degree	
Thermal resistance	-	20	$^{\circ}\text{C}/\text{W}$	
CRI	-	>80	-	
CCT	(Cool White) (Neutral White) (Warm White)	-	2,700	K
		-	3,000	
		-	3,500	
		-	4,000	
		-	5,000	
		-	5,700 6,500	
JEDEC Moisture Sensitivity	-	Level 2a Floor Life Conditions: $\leq 30^{\circ}\text{C}$ / 60% RH Soak Requirements(Standard) Time (hours): 120+1/-0 Conditions: 60 $^{\circ}\text{C}$ / 60% RH		

Notes:

1. $2\theta_{1/2}$ is the off-axis angle where the luminous intensity is half of the axial luminous intensity.
2. Color Rendering index CRI tolerance: ± 2 .
3. CIE_x/y tolerance: ± 0.005 .

Electro - Optical Characteristics (Neutral White)

$I_f=65\text{mA}$ and $T_j=25^\circ\text{C}$

If (mA)	Vf (V)	Power (W)	lm	lm/W
20	2.70	0.054	11.0	204
40	2.78	0.111	22.0	198
60	2.80	0.168	32.0	190
65 (Typ.)	2.84	0.185	34.5	186
80	2.93	0.234	42.0	179
100	3.00	0.300	51.0	170
150	3.08	0.462	73.0	158

Note:
LM Values are for representative reference only.

Luminous Flux Characteristic

Luminous Flux Characteristics, $I_f=65\text{mA}$ and $T_j=25^\circ\text{C}$

Color	Group	Min. Luminous Flux(lm)	Max. Luminous Flux(lm)	Forward Current (mA)	Order Code		
Cool White	30	30	32	65	2T03X8CW11000014		
	32	32	34				
	34	34	36				
	36	36	38				
Neutral White	30	30	32		65	2T03X8NW11000014	
	32	32	34				
	34	34	36				
	36	36	38				
Warm White	28	28	30			65	2T03X8WW11000014
	30	30	32				
	32	32	34				
	34	34	36				

Note:

The luminous flux performance is guaranteed within published operating conditions. Edison Opto maintains a tolerance of $\pm 10\%$ on flux measurements.

Voltage Bin Structure

Group	Min. Voltage (V)	Max. Voltage (V)
VC0	2.7	2.8
VA1	2.8	2.9
VB1	2.9	3.0
VC1	3.0	3.1
VA2	3.1	3.2

Note:

Forward voltage measurement allowance is $\pm 0.06\text{V}$.

Mechanical Dimensions

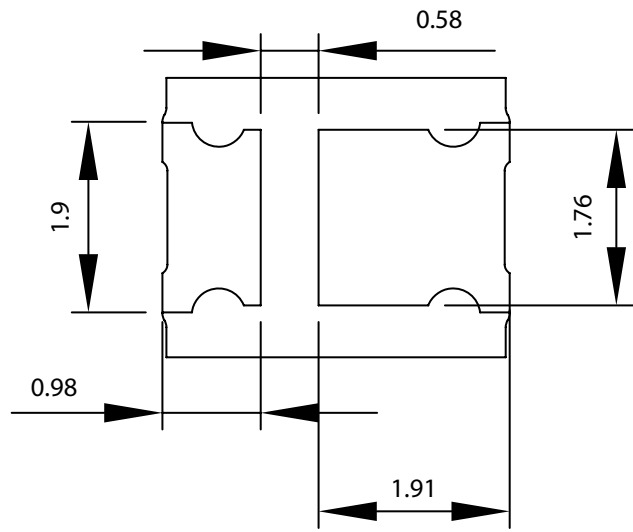
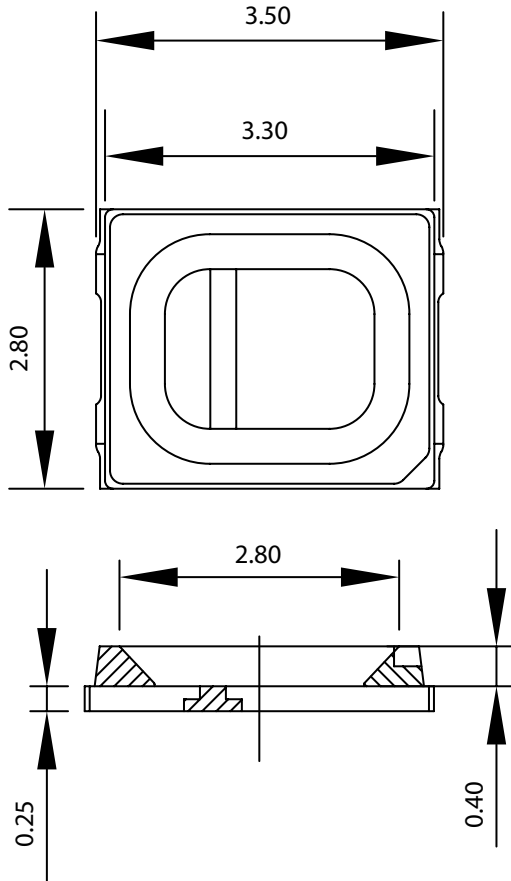

Circuit



Solder Pad

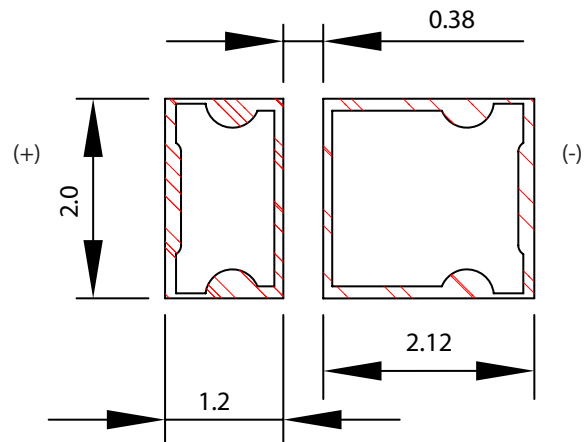

- Notes:
1. All dimensions are measured in mm.
 2. Tolerance : ± 0.20 mm

Color BIN code

Color region stay within Macadam "3-Step/5-step" ellipse from the chromaticity center.

The chromaticity center refers to ANSI C78.377:2008.

Please refer to ANSI C78.377 for the chromaticity center.

CCT	Steps	Cx	Cy	a	b	theta
2700K	5	0.4578	0.4101	0.01350	0.00700	53.70
3000K	5	0.4338	0.4030	0.01390	0.00680	53.22
3500K	5	0.4073	0.3917	0.01545	0.00690	54.00
4000K	5	0.3818	0.3797	0.01565	0.00670	53.72
5000K	5	0.3447	0.3553	0.01370	0.00590	59.62
5700K	5	0.3287	0.3417	0.01243	0.00533	59.09
6500K	5	0.3123	0.3282	0.01115	0.00475	58.57

CCT	Steps	Cx	Cy	a	b	theta
2700K	3	0.4578	0.4101	0.00810	0.00420	53.70
3000K	3	0.4338	0.4030	0.00834	0.00408	53.22
3500K	3	0.4073	0.3917	0.00927	0.00414	54.00
4000K	3	0.3818	0.3797	0.00939	0.00402	53.72
5000K	3	0.3447	0.3553	0.00822	0.00354	59.62
5700K	3	0.3287	0.3417	0.00746	0.00320	59.09
6500K	3	0.3123	0.3282	0.00669	0.00285	58.57

Cool White

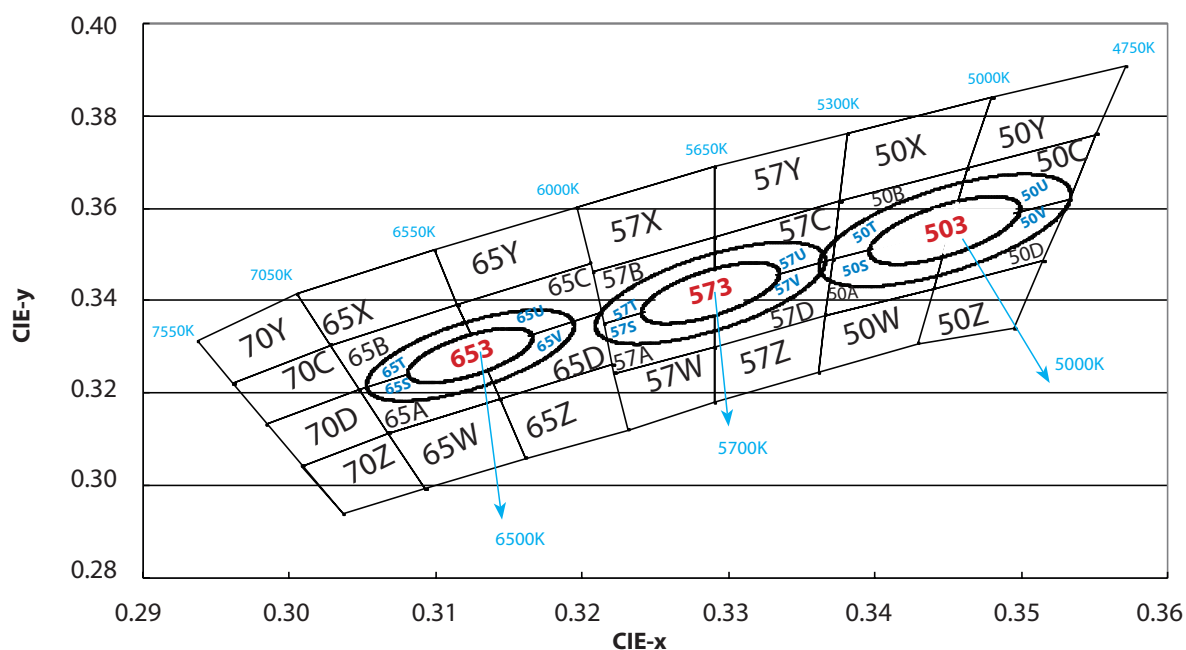

Neutral White

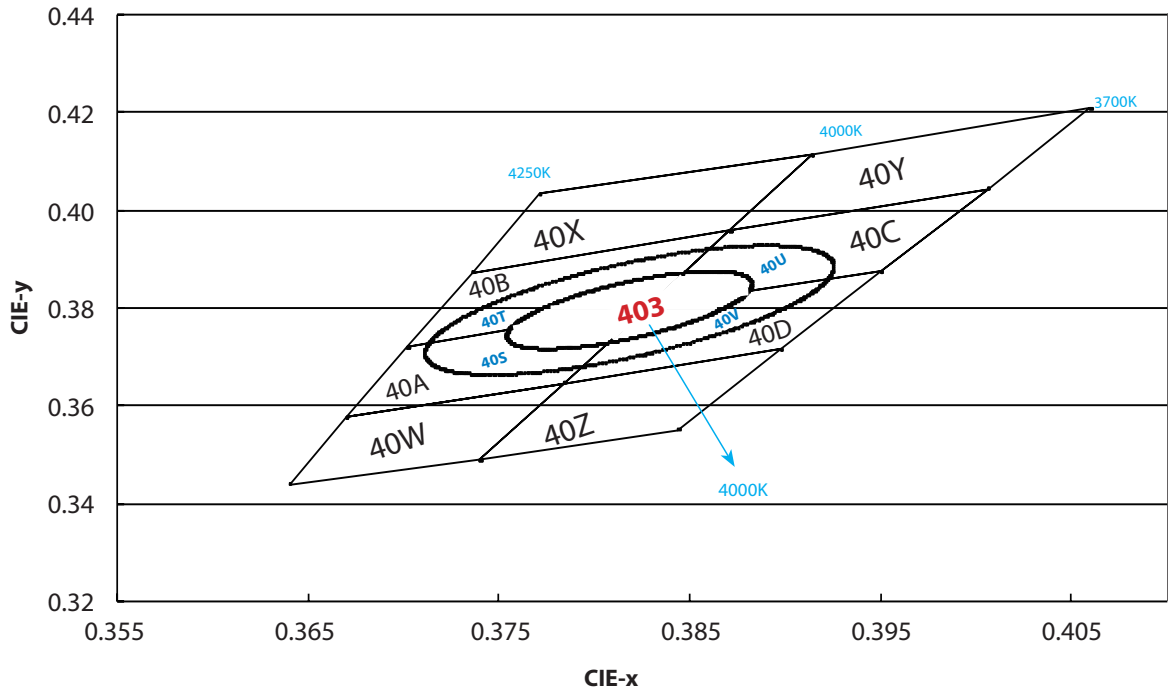

Warm White

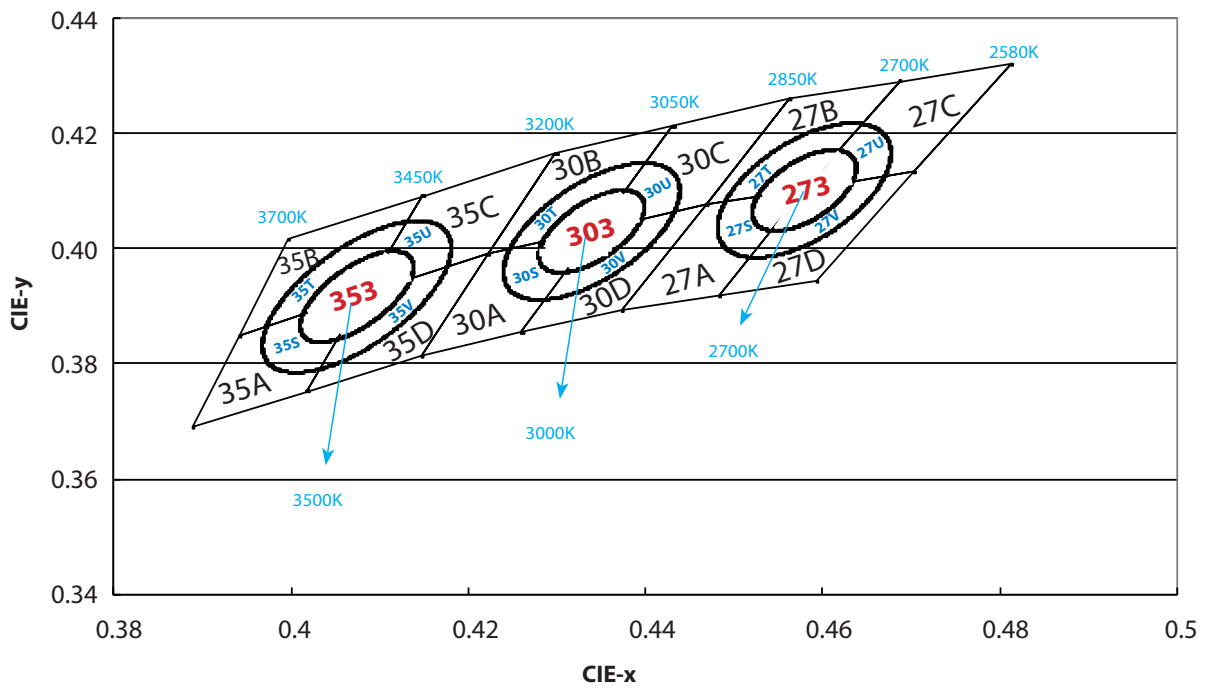

6500K

65X		65B		65A		65W	
X	Y	X	Y	X	Y	X	Y
0.3005	0.3415	0.3115	0.3391	0.3130	0.3290	0.3068	0.3113
0.3099	0.3509	0.3028	0.3304	0.3048	0.3207	0.3144	0.3186
0.3115	0.3391	0.3048	0.3207	0.3068	0.3113	0.3161	0.3059
0.3028	0.3304	0.3130	0.3290	0.3144	0.3186	0.3093	0.2993

65Y		65C		65D		65Z	
X	Y	X	Y	X	Y	X	Y
0.3099	0.3509	0.3205	0.3481	0.3213	0.3373	0.3144	0.3186
0.3196	0.3602	0.3115	0.3391	0.3130	0.3290	0.3221	0.3261
0.3205	0.3481	0.3130	0.3290	0.3144	0.3186	0.3231	0.3120
0.3115	0.3391	0.3213	0.3373	0.3221	0.3261	0.3161	0.3059

5700K

57X		57B		57A		57W	
X	Y	X	Y	X	Y	X	Y
0.3196	0.3602	0.3290	0.3538	0.3290	0.3417	0.3222	0.3243
0.3290	0.3690	0.3207	0.3462	0.3215	0.3350	0.3290	0.3300
0.3290	0.3538	0.3215	0.3350	0.3222	0.3243	0.3290	0.3180
0.3207	0.3462	0.3290	0.3417	0.3290	0.3300	0.3231	0.3120

57Y		57C		57D		57Z	
X	Y	X	Y	X	Y	X	Y
0.3290	0.3690	0.3376	0.3616	0.3371	0.3490	0.3290	0.3300
0.3381	0.3762	0.3290	0.3538	0.3290	0.3417	0.3366	0.3369
0.3376	0.3616	0.3290	0.3417	0.3290	0.3300	0.3361	0.3245
0.3290	0.3538	0.3371	0.3490	0.3366	0.3369	0.3290	0.3180

5000K

50X		50B		50A		50W	
X	Y	X	Y	X	Y	X	Y
0.3381	0.3762	0.3463	0.3687	0.3451	0.3554	0.3366	0.3369
0.3480	0.3840	0.3376	0.3616	0.3371	0.3490	0.3440	0.3427
0.3463	0.3687	0.3371	0.3490	0.3366	0.3369	0.3429	0.3307
0.3376	0.3616	0.3451	0.3554	0.3440	0.3427	0.3361	0.3245

50Y		50C		50D		50Z	
X	Y	X	Y	X	Y	X	Y
0.3480	0.3840	0.3551	0.3760	0.3533	0.3620	0.3440	0.3427
0.3571	0.3907	0.3463	0.3687	0.3451	0.3554	0.3515	0.3487
0.3551	0.3760	0.3451	0.3554	0.3440	0.3427	0.3495	0.3339
0.3463	0.3687	0.3533	0.3620	0.3515	0.3487	0.3429	0.3307

4000K

40X		40B		40A		40W	
X	Y	X	Y	X	Y	X	Y
0.3771	0.4034	0.3871	0.3959	0.3828	0.3803	0.3670	0.3578
0.3736	0.3874	0.3736	0.3874	0.3702	0.3722	0.3640	0.3440
0.3871	0.3959	0.3702	0.3722	0.3670	0.3578	0.3740	0.3491
0.3914	0.4115	0.3828	0.3803	0.3784	0.3647	0.3784	0.3647

40Y		40C		40D		40Z	
X	Y	X	Y	X	Y	X	Y
0.3914	0.4115	0.4006	0.4044	0.3950	0.3875	0.3784	0.3647
0.3871	0.3959	0.3871	0.3959	0.3828	0.3803	0.3740	0.3491
0.4006	0.4044	0.3828	0.3803	0.3784	0.3647	0.3844	0.3552
0.4060	0.4208	0.3950	0.3875	0.3898	0.3716	0.3898	0.3716

3500K

35A		35B		35C		35D	
X	Y	X	Y	X	Y	X	Y
0.4083	0.3921	0.4148	0.4090	0.4299	0.4165	0.4223	0.399
0.3941	0.3848	0.3996	0.4015	0.4148	0.4090	0.4083	0.3921
0.3889	0.3690	0.3941	0.3848	0.4083	0.3921	0.4018	0.3752
0.4018	0.3752	0.4083	0.3921	0.4223	0.399	0.4147	0.3814

3000K

30A		30B		30C		30D	
X	Y	X	Y	X	Y	X	Y
0.4345	0.4033	0.4431	0.4213	0.4562	0.4260	0.4468	0.4077
0.4223	0.3990	0.4299	0.4165	0.4431	0.4213	0.4345	0.4033
0.4147	0.3814	0.4223	0.3990	0.4345	0.4033	0.4260	0.3854
0.4260	0.3854	0.4345	0.4033	0.4468	0.4077	0.4373	0.3893

2700K

27A		27B		27C		27D	
X	Y	X	Y	X	Y	X	Y
0.4578	0.4101	0.4687	0.4289	0.4813	0.4319	0.4703	0.4132
0.4468	0.4077	0.4562	0.4260	0.4687	0.4289	0.4578	0.4101
0.4373	0.3893	0.4468	0.4077	0.4578	0.4101	0.4483	0.3919
0.4483	0.3919	0.4578	0.4101	0.4703	0.4132	0.4593	0.3944

Characteristic curve

Color Spectrum

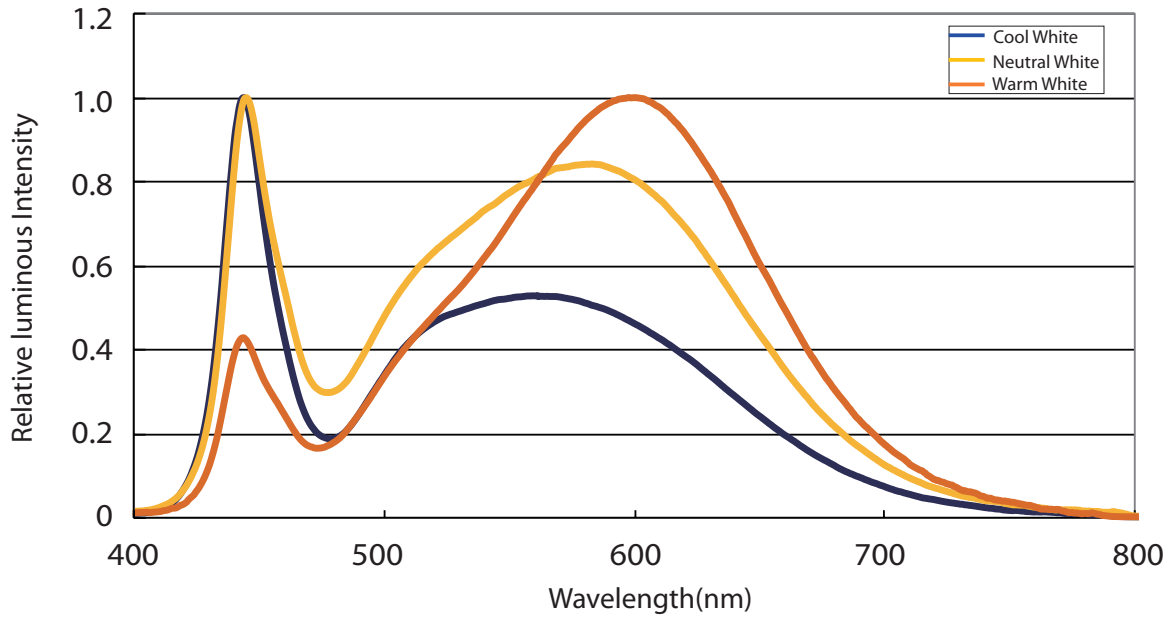

Beam Pattern

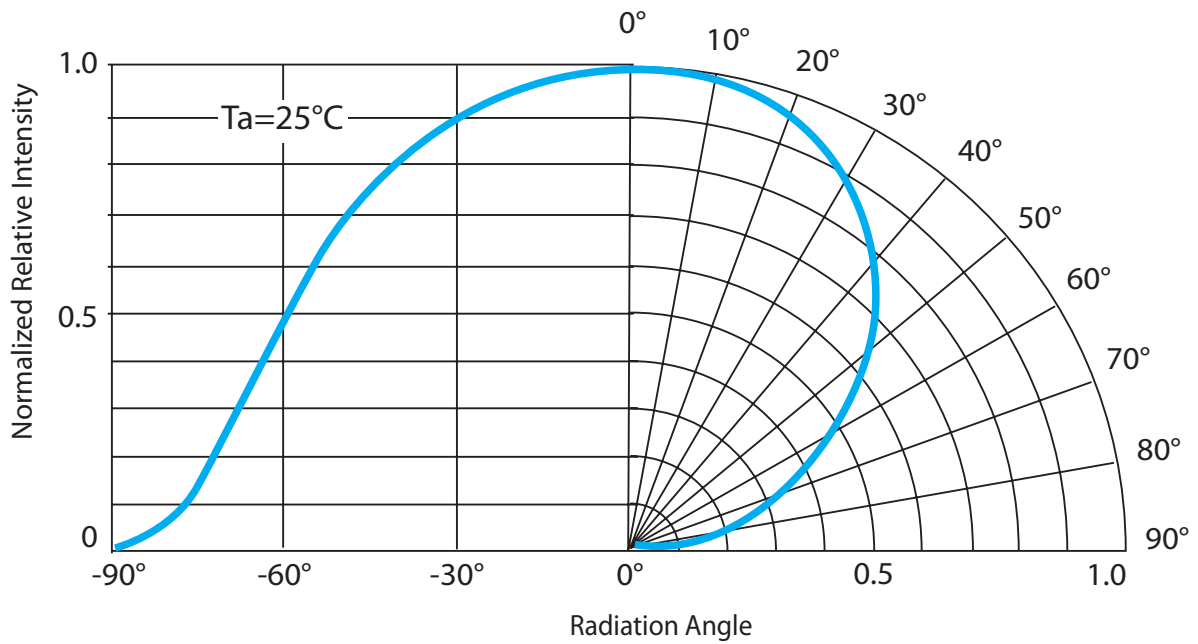

Forward Current vs. Forward Voltage

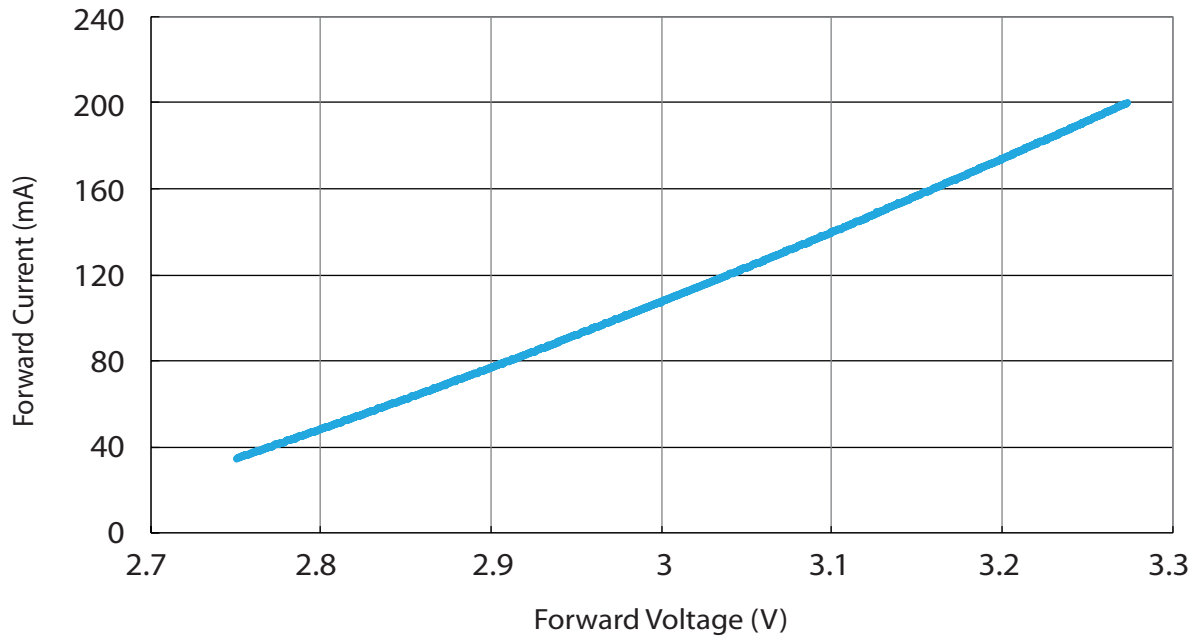

Relative Luminous Intensity vs. Forward Current

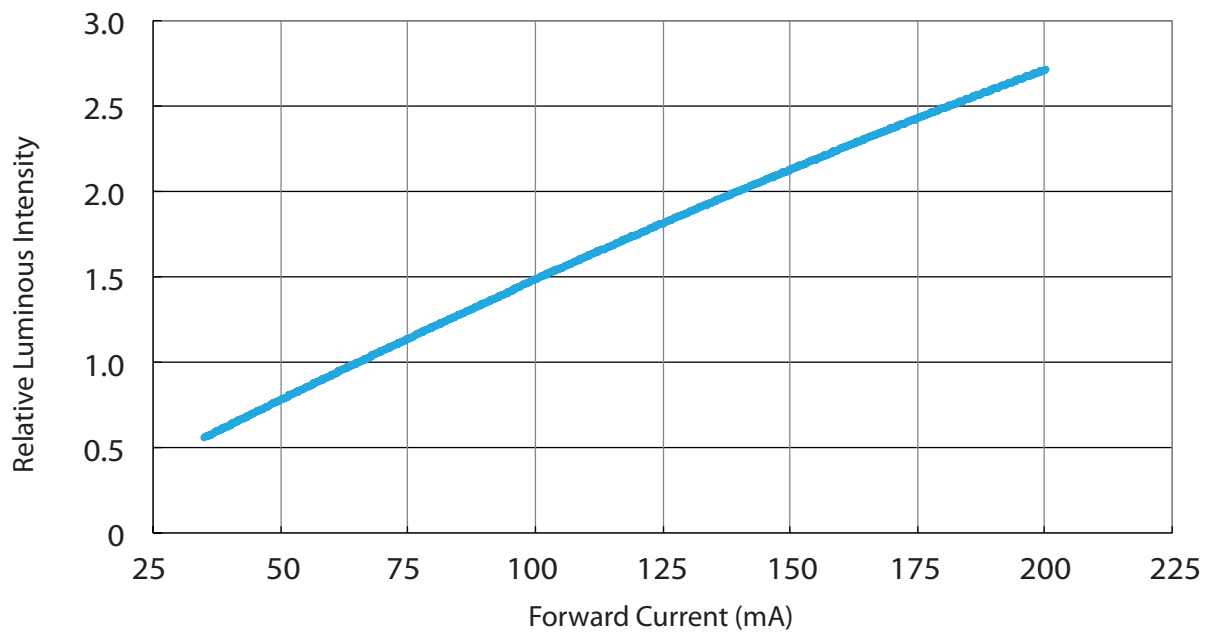

Relative Luminous Flux vs. Junction Temperature

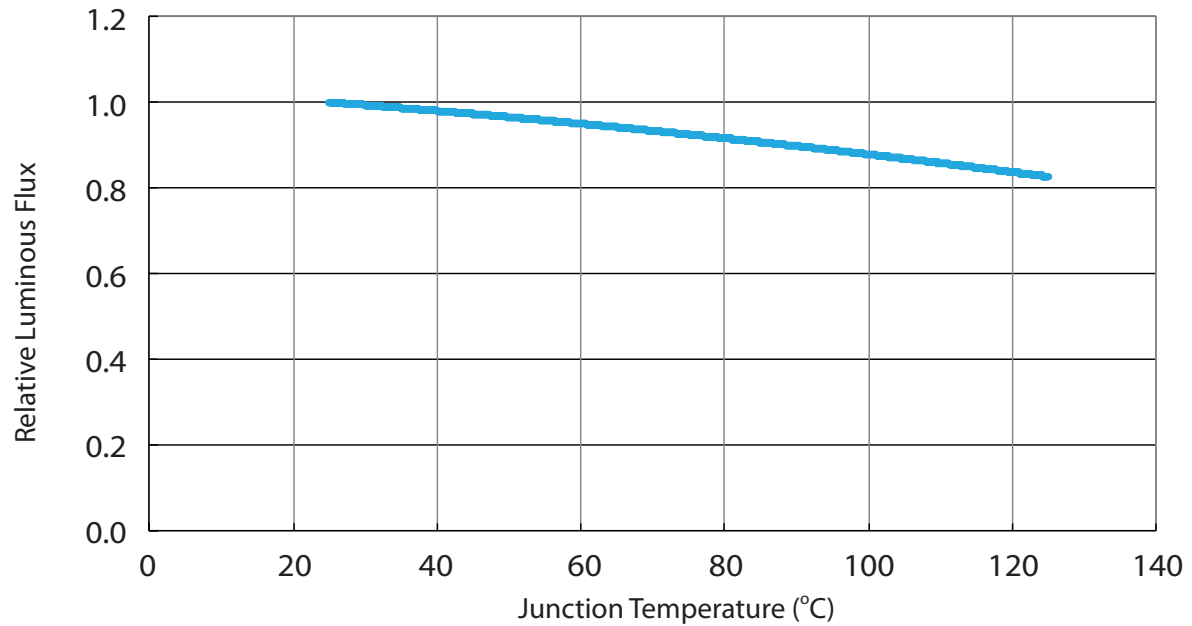

Forward Voltage vs. Junction Temperature

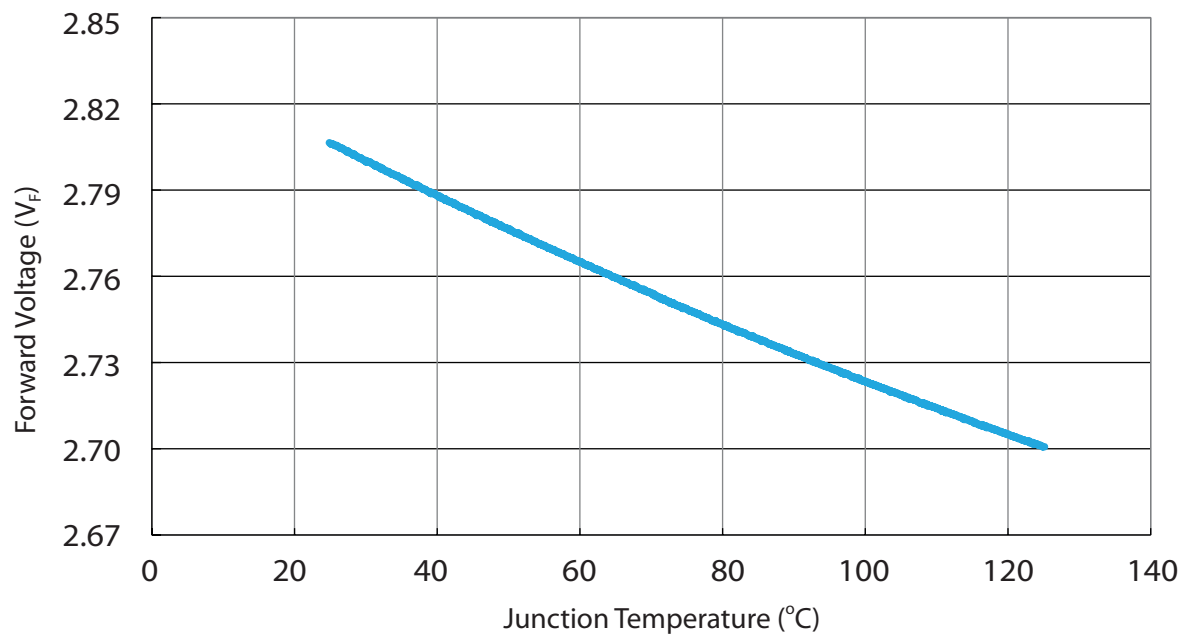

$\Delta x, \Delta y$ vs. Forward Current

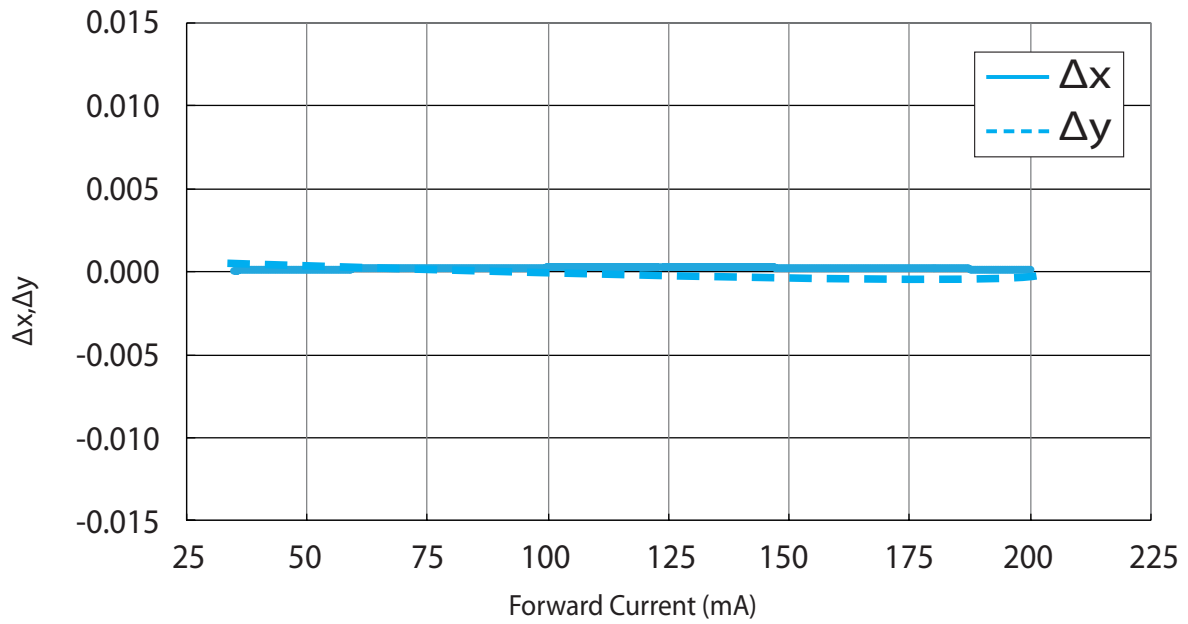

$\Delta x, \Delta y$ vs. Junction Temperature

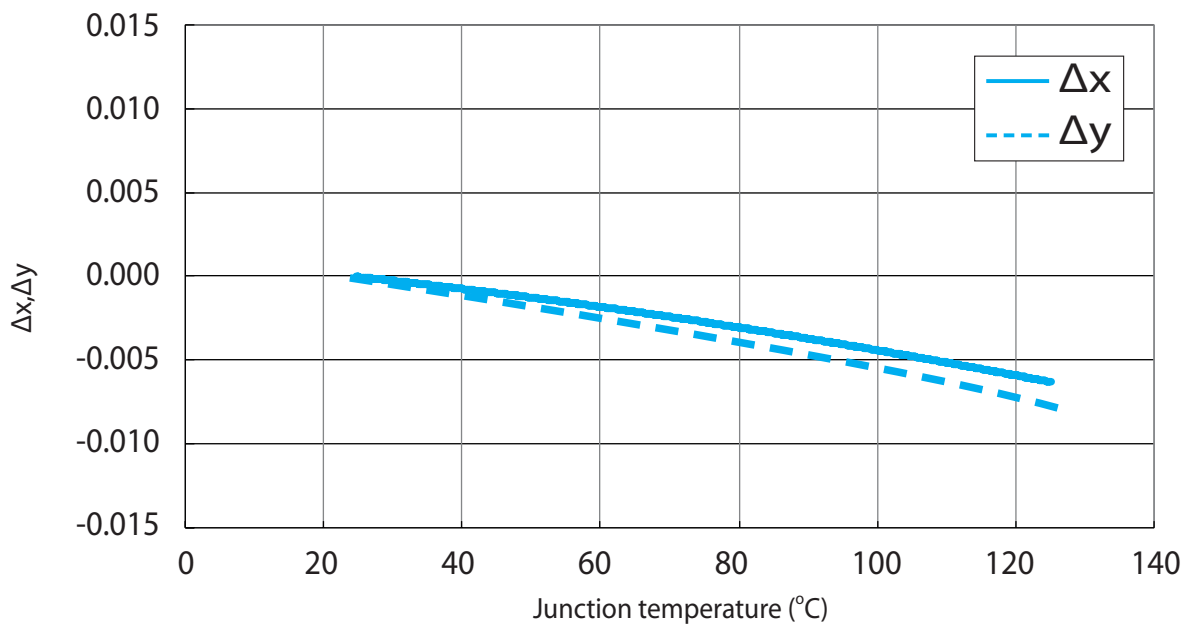

Maximum Current vs. Ambient Temperature

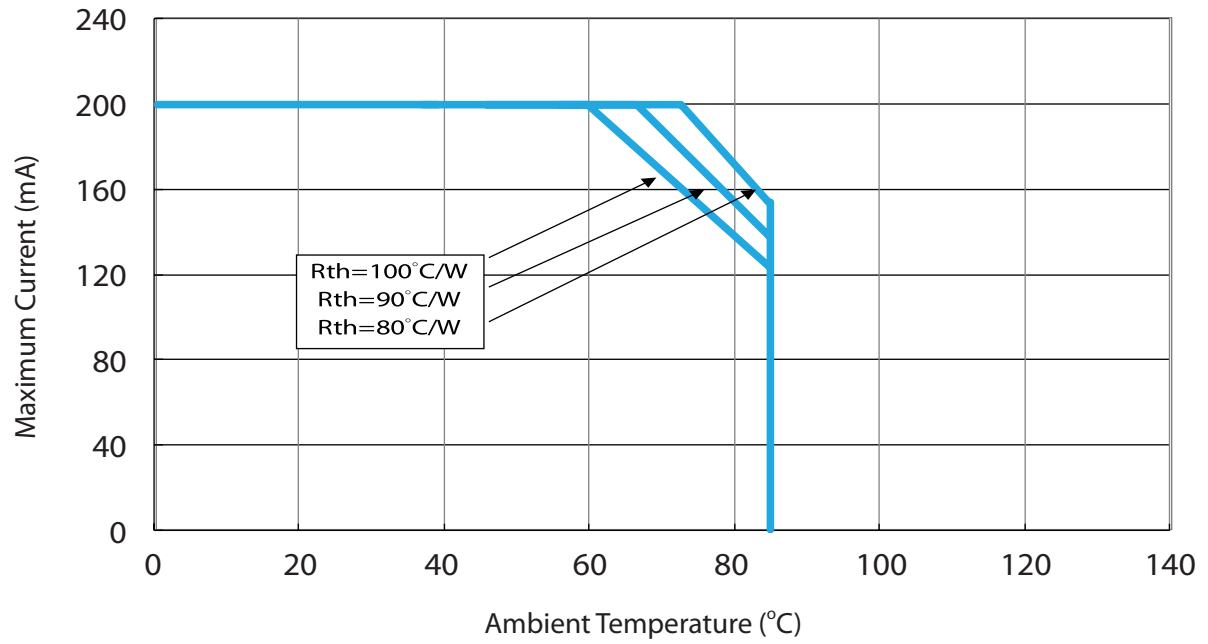

Reflow Profile

The following reflow profile is from IPC/JEDEC J-STD-020D which provided here for reference.

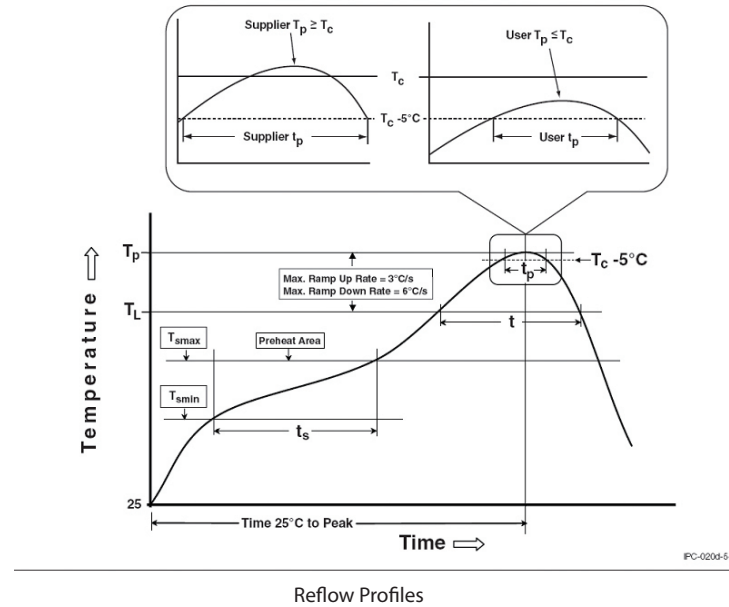

Classification Reflow Profiles

Profile Feature	Pb-Free Assembly
Preheat & Soak	
Temperature min (T_{smin})	150 °C
Temperature max (T_{smax})	200 °C
Time (T_{smin} to T_{smax}) (t_s)	60-120 seconds
Average ramp-up rate (T_{smax} to T_p)	3 °C/second max.
Liquidous temperature (T_L)	217 °C
Time at liquidous (t_L)	60-150 seconds
Peak package body temperature (T_p)*	255 °C ~260 °C *
Classification temperature (T_c)	260 °C
Time (t_p)** within 5 °C of the specified classification temperature (T_c)	30** seconds
Average ramp-down rate (T_p to T_{smax})	6°C/second max.
Time 25°C to peak temperature	8 minutes max.

Notes:

- * Tolerance for peak profile temperature (T_p) is defined as a supplier minimum and a user maximum.
- ** Tolerance for time at peak profile temperature (t_p) is defined as a supplier minimum and a user maximum.

Reliability

NO .	Test Item	Test Condition	Remark
1	Temperature Cycle	-40°C~100°C 30, 30, mins	100 Cycle
2	Thermal Shock	-40°C~100°C 15, 15 mins ≤ 10 sec	100 Cycle
3	Resistance to Soldering Heat	T _{SOL} =260°C, 30 sec	3 times
4	Moisture Resistance	25°C~65°C 90% RH 24 hrs / 1 cycle	10 Cycle
5	High-Temperature Storage	T _A =100°C	1,000 hrs
6	Humidity Heat Storage	T _A =85°C RH=85%	1,000 hrs
7	Low-Temperature Storage	T _A =-40°C	1,000 hrs
8	Operation Life test	25°C	1,000 hrs
9	High Temperature Operation Life test	85°C	1,000 hrs
10	High Humidity Heat Life Test	85°C, 85%RH	1,000 hrs
11	ON/OFF Test	30 sec ON, 30 sec OFF	1.5W times

Failure Criteria

Item	Criteria for Judgment	
	Min.	Max.
Lumen Maintenance	85%	-
$\Delta u'v'$	-	0.006
Forward Voltage	-	Initial Data x 1.1
Reverse Current	-	10 μ A
Resistance to Soldering Heat	No dead lamps or visual damage	

Product Packaging Information

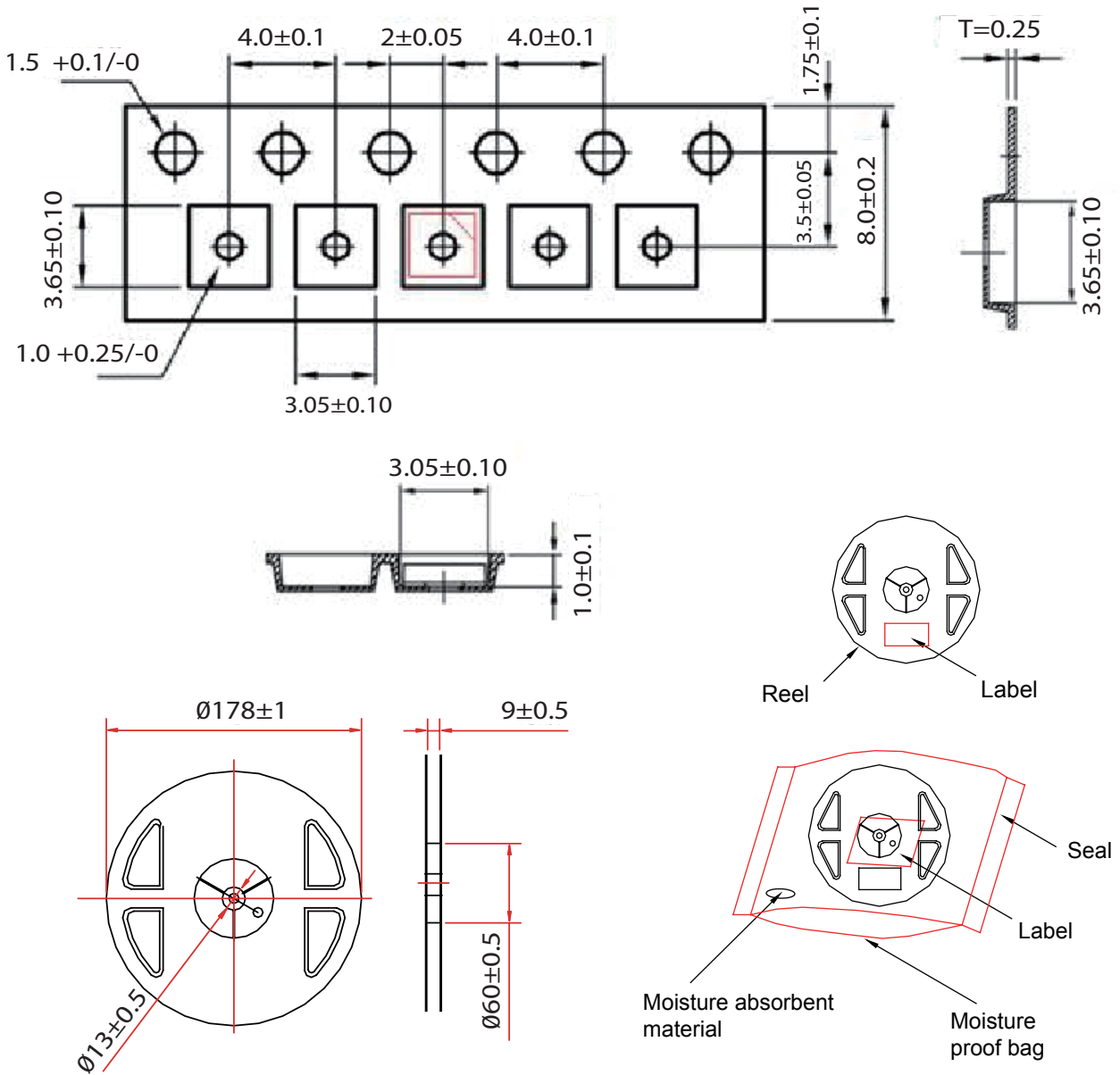

Item	Quantity	Total	Dimensions(mm)
Reel	4,000pcs	4,000pcs	R=178
Starting with 150pcs empty, and 150pcs empty at the last			

Revision History

Versions	Description	Release Date
1	Establish order code information	2015/05/22
2	Add LM Values for reference only	2015/05/29

About Edison Opto

Edison Opto is a leading manufacturer of high power LED and a solution provider experienced in LDMS. LDMS is an integrated program derived from the four essential technologies in LED lighting applications- Thermal Management, Electrical Scheme, Mechanical Refinement, Optical Optimization, to provide customer with various LED components and modules. More Information about the company and our products can be found at www.edison-opto.com

Copyright©2015 Edison Opto. All rights reserved. No part of publication may be reproduced or transmitted in any form or by any means, electronic or mechanical, including photo copy, recording or any other information storage and retrieval system, without prior permission in writing from the publisher. The information in this publication are subject to change without notice.

www.edison-opto.com

For general assistance please contact:
service@edison-opto.com.tw

For technical assistance please contact:
LED.Detective@edison-opto.com.tw