

EMILY-RS

~8° spot beam. 14.74 mm high lens.

SPECIFICATION:

Dimensions	Ø 26.0 mm
Height	14.7 mm
Fastening	tape
ROHS compliant	yes ⓘ

MATERIALS:

Component	Type	Material	Colour	Finish
EMILY-RS	Single lens	PMMA	clear	
SPUTNIK-TAPE	Tape	Acrylic foam	black	

ORDERING INFORMATION:

Component		Qty in box	MOQ	MPQ	Box weight (kg)
CA13546_EMILY-RS	Single lens	1690	260	130	10.3
» Box size: 480 x 280 x 300 mm					



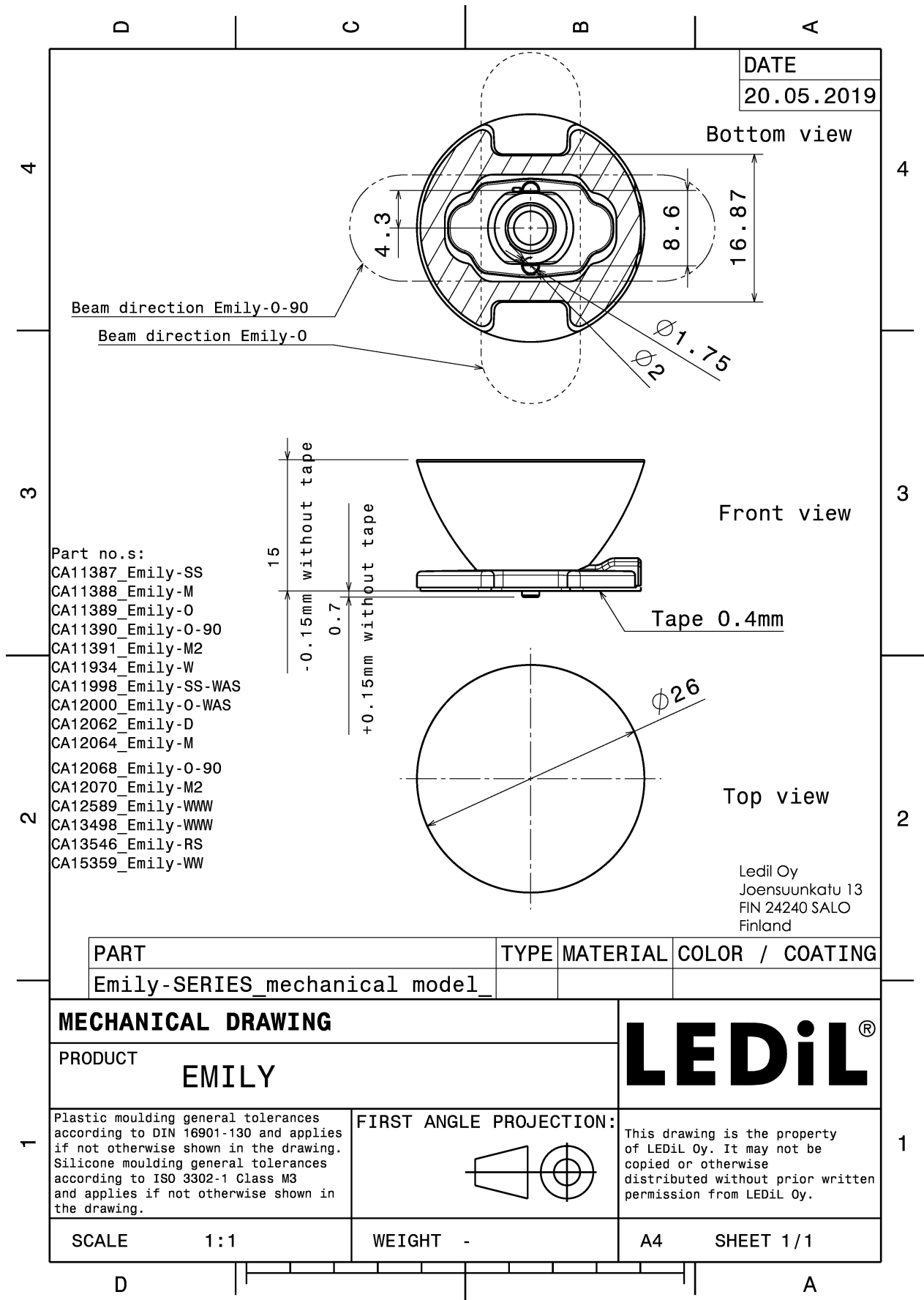

See also our general installation guide: www.ledil.com/installation_guide

OPTICAL RESULTS (MEASURED):



LED XB-H
 FWHM / FWTM 9.0° / 17.0°
 Efficiency 88 %
 Peak intensity 24.7 cd/lm
 LEDs/each optic 1
 Light colour White
 Required components:

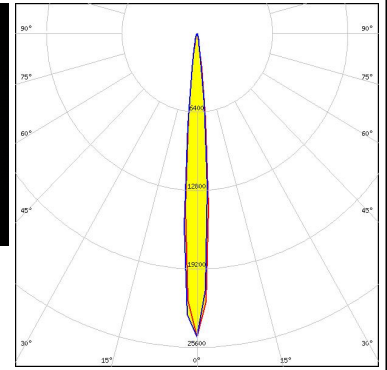

LED XP-E2
 FWHM / FWTM 6.0° / 11.0°
 Efficiency 96 %
 Peak intensity 57.6 cd/lm
 LEDs/each optic 1
 Light colour White
 Required components:

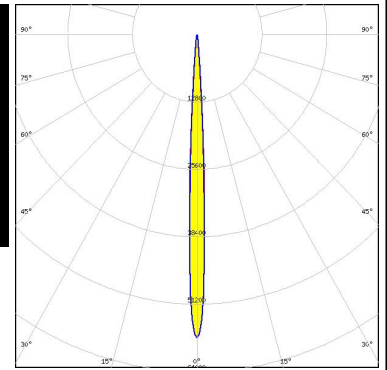
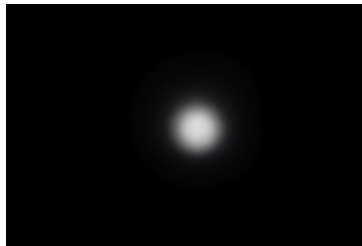



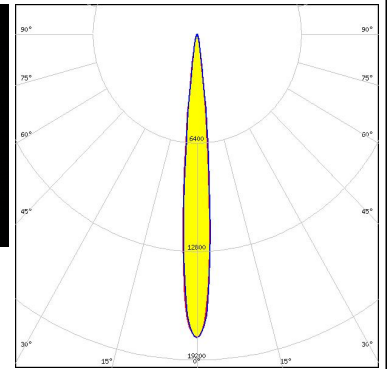

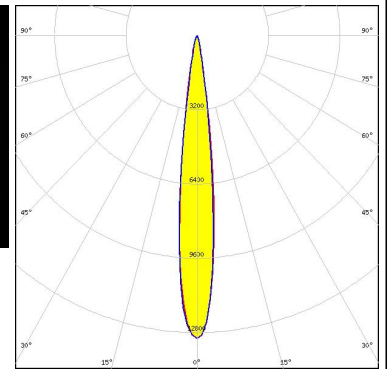

LED XP-G3
 FWHM / FWTM 10.0° / 18.0°
 Efficiency 94 %
 Peak intensity 18 cd/lm
 LEDs/each optic 1
 Light colour White
 Required components:

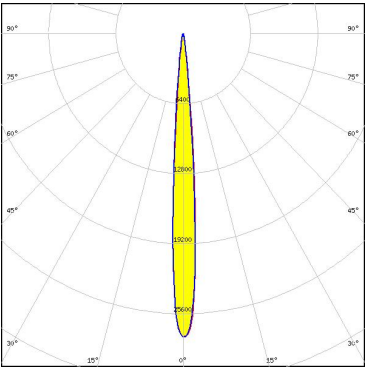

LED XP-L HD
 FWHM / FWTM 13.0° / 23.0°
 Efficiency 89 %
 Peak intensity 13.1 cd/lm
 LEDs/each optic 1
 Light colour White
 Required components:

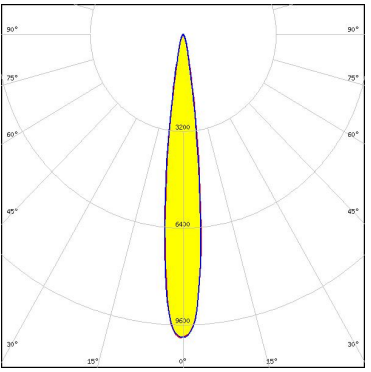

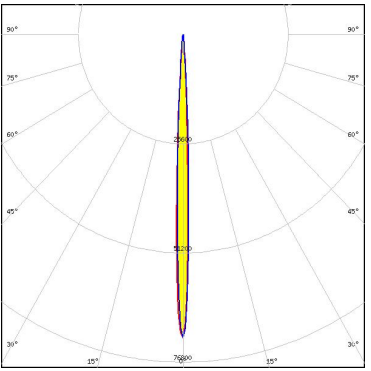
OPTICAL RESULTS (MEASURED):

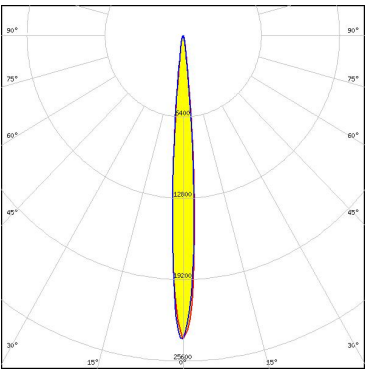
<p>CREE LEDs</p> <p>LED XP-L HI FWHM / FWTM 8.0° / 15.0° Efficiency 88 % Peak intensity 28 cd/lm LEDs/each optic 1 Light colour White Required components:</p>		
<p>CREE LEDs</p> <p>LED XP-L2 FWHM / FWTM 13.0° / 25.0° Efficiency 93 % Peak intensity 10 cd/lm LEDs/each optic 1 Light colour White Required components:</p>		
<p>CREE LEDs</p> <p>LED XQ-E HI FWHM / FWTM 4.0° / 9.0° Efficiency 94 % Peak intensity 71.1 cd/lm LEDs/each optic 1 Light colour White Required components:</p>		
<p>CREE LEDs</p> <p>LED XT-E FWHM / FWTM 8.0° / 16.0° Efficiency 91 % Peak intensity 23.9 cd/lm LEDs/each optic 1 Light colour White Required components:</p>		

OPTICAL RESULTS (MEASURED):

LUMILEDS

LED LUXEON Z ES
 FWHM / FWTM 5.0° / 11.0°
 Efficiency 91 %
 Peak intensity 52 cd/lm
 LEDs/each optic 1
 Light colour White
 Required components:

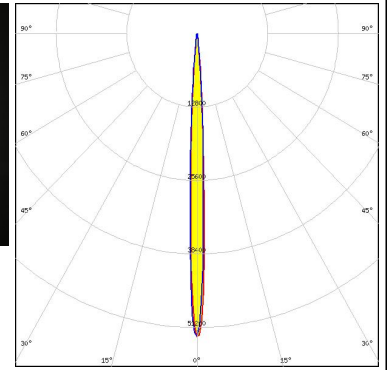

NICHIA

LED NVSW219D
 FWHM / FWTM 10.0° / 18.0°
 Efficiency 94 %
 Peak intensity 20.1 cd/lm
 LEDs/each optic 1
 Light colour White
 Required components:

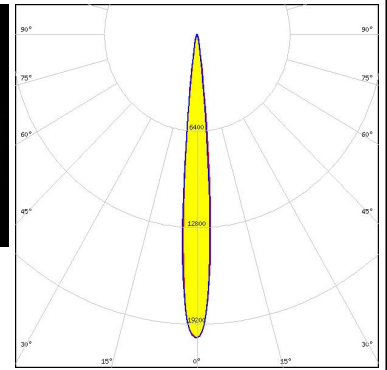

NICHIA

LED NVSW719AC
 FWHM / FWTM 9.0° / 15.0°
 Efficiency 95 %
 Peak intensity 28.4 cd/lm
 LEDs/each optic 1
 Light colour White
 Required components:

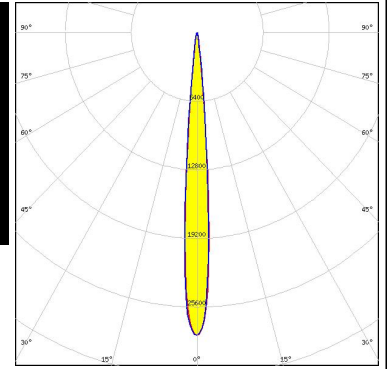

OSRAM

Opto Semiconductors
 LED OSLOM Square EC
 FWHM / FWTM 8.0° / 15.0°
 Efficiency 90 %
 Peak intensity 29.1 cd/lm
 LEDs/each optic 1
 Light colour White
 Required components:

OPTICAL RESULTS (MEASURED):

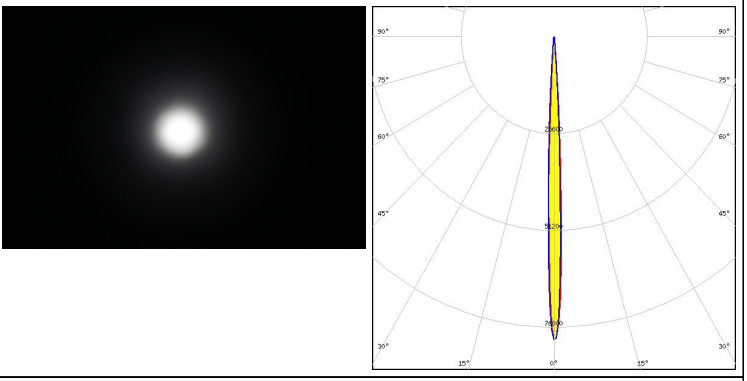
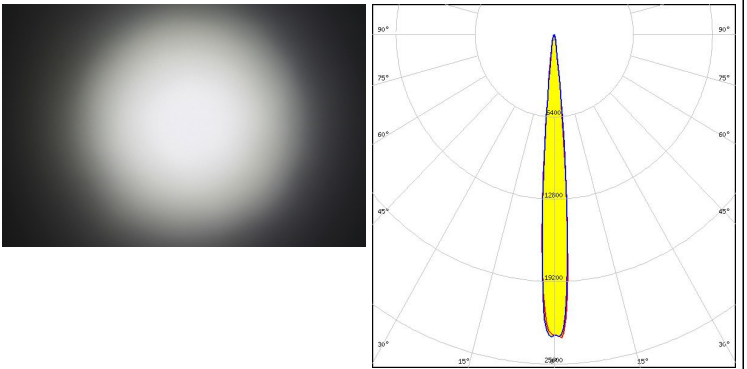
<p>OSRAM Opto Semiconductors</p> <p>LED PLPVEC2 850A FWHM / FWTM 4.0° / 11.0° Efficiency % LEDs/each optic 1 Light colour IR Required components:</p>	
<p>SEOUL SEMICONDUCTOR</p> <p>LED nPola FWHM / FWTM 5.0° Efficiency 94 % Peak intensity 81.2 cd/lm LEDs/each optic 1 Light colour White Required components:</p>	
<p>SEOUL SEMICONDUCTOR</p> <p>LED Z5M1/Z5M2 FWHM / FWTM 9.0° / 15.0° Efficiency 91 % Peak intensity 23.7 cd/lm LEDs/each optic 1 Light colour White Required components:</p>	

OPTICAL RESULTS (SIMULATED):



LED XHP35 HI
 FWHM / FWTM 10.0° / 18.0°
 Efficiency 96 %
 Peak intensity 22 cd/lm
 LEDs/each optic 1
 Light colour White
 Required components:

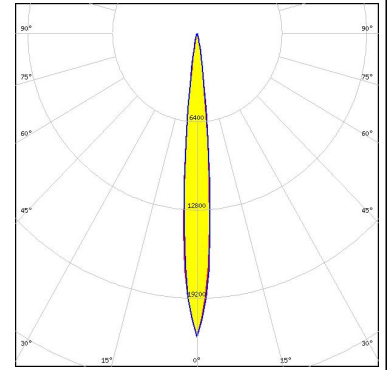

LED XP-G2
 FWHM / FWTM 8.0° / 16.0°
 Efficiency 94 %
 Peak intensity 30.4 cd/lm
 LEDs/each optic 1
 Light colour White
 Required components:

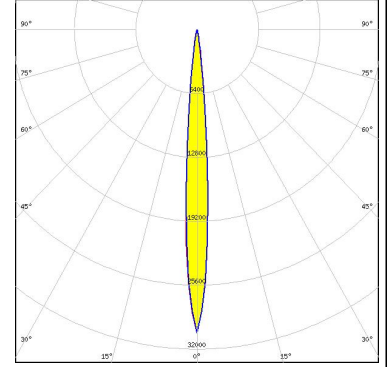

LED XP-G2 HE
 FWHM / FWTM 10.0° / 20.0°
 Efficiency 95 %
 Peak intensity 19.1 cd/lm
 LEDs/each optic 1
 Light colour White
 Required components:

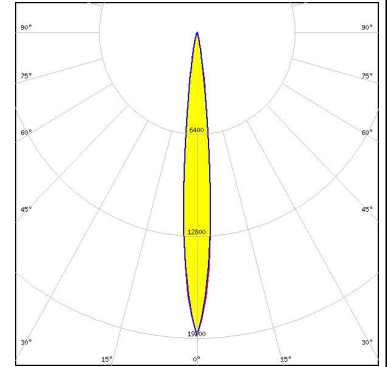

LED XP-P
 FWHM / FWTM 6.0° / 12.0°
 Efficiency 96 %
 Peak intensity 63.8 cd/lm
 LEDs/each optic 1
 Light colour White
 Required components:

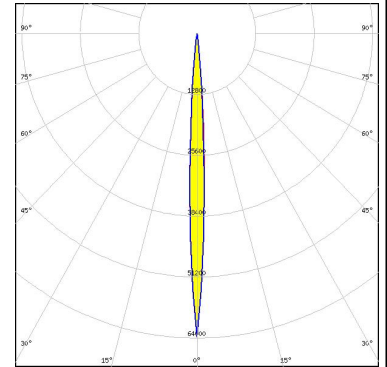

OPTICAL RESULTS (SIMULATED):

<p>LUMILEDS</p> <p>LED: LUXEON C</p> <p>FWHM / FWTM: 7.0° / 16.0°</p> <p>Efficiency: 94 %</p> <p>Peak intensity: 37.3 cd/lm</p> <p>LEDs/each optic: 1</p> <p>Light colour: Royal Blue</p> <p>Required components:</p>	
<p>LUMILEDS</p> <p>LED: LUXEON HL2Z</p> <p>FWHM / FWTM: 8.0° / 18.0°</p> <p>Efficiency: 96 %</p> <p>Peak intensity: 27.7 cd/lm</p> <p>LEDs/each optic: 1</p> <p>Light colour: White</p> <p>Required components:</p>	
<p>LUMILEDS</p> <p>LED: LUXEON MZ</p> <p>FWHM / FWTM: 14.0° / 26.0°</p> <p>Efficiency: 95 %</p> <p>Peak intensity: 10.7 cd/lm</p> <p>LEDs/each optic: 1</p> <p>Light colour: White</p> <p>Required components:</p>	
<p>LUMILEDS</p> <p>LED: LUXEON Rebel</p> <p>FWHM / FWTM: 6.0° / 14.0°</p> <p>Efficiency: 94 %</p> <p>Peak intensity: 41.5 cd/lm</p> <p>LEDs/each optic: 1</p> <p>Light colour: White</p> <p>Required components:</p>	

OPTICAL RESULTS (SIMULATED):

<p>LUMILEDS</p> <p>LED: LUXEON Rebel Plus</p> <p>FWHM / FWTM: 6.0° / 14.0°</p> <p>Efficiency: 94 %</p> <p>Peak intensity: 42.1 cd/lm</p> <p>LEDs/each optic: 1</p> <p>Light colour: White</p> <p>Required components:</p>	
<p>LUMILEDS</p> <p>LED: LUXEON Rubix</p> <p>FWHM / FWTM: 6.0° / 12.0°</p> <p>Efficiency: 96 %</p> <p>Peak intensity: 63.9 cd/lm</p> <p>LEDs/each optic: 1</p> <p>Light colour: Blue</p> <p>Required components:</p>	
<p>LUMILEDS</p> <p>LED: LUXEON Rubix</p> <p>FWHM / FWTM: 6.0° / 12.0°</p> <p>Efficiency: 96 %</p> <p>Peak intensity: 64.5 cd/lm</p> <p>LEDs/each optic: 1</p> <p>Light colour: Green</p> <p>Required components:</p>	
<p>LUMILEDS</p> <p>LED: LUXEON Rubix</p> <p>FWHM / FWTM: 6.0° / 12.0°</p> <p>Efficiency: 96 %</p> <p>Peak intensity: 62.6 cd/lm</p> <p>LEDs/each optic: 1</p> <p>Light colour: White</p> <p>Required components:</p>	

OPTICAL RESULTS (SIMULATED):

<p>LUMILEDS</p> <p>LED LUXEON Rubix</p> <p>FWHM / FWTM 6.0° / 12.0°</p> <p>Efficiency 96 %</p> <p>Peak intensity 67.4 cd/lm</p> <p>LEDs/each optic 1</p> <p>Light colour Red</p> <p>Required components:</p>	
<p>LUMILEDS</p> <p>LED LUXEON SunPlus 20 Line (120 deg)</p> <p>FWHM / FWTM 6.0° / 13.0°</p> <p>Efficiency 96 %</p> <p>Peak intensity 50.8 cd/lm</p> <p>LEDs/each optic 1</p> <p>Light colour White</p> <p>Required components:</p>	
<p>LUMILEDS</p> <p>LED LUXEON Z</p> <p>FWHM / FWTM 5.9° / 12.0°</p> <p>Efficiency 94 %</p> <p>Peak intensity 65.3 cd/lm</p> <p>LEDs/each optic 1</p> <p>Light colour White</p> <p>Required components:</p>	
<p>NICHIA</p> <p>LED NCSxE17A</p> <p>FWHM / FWTM 6.0° / 16.0°</p> <p>Efficiency 93 %</p> <p>Peak intensity 35.5 cd/lm</p> <p>LEDs/each optic 1</p> <p>Light colour White</p> <p>Required components:</p>	

OPTICAL RESULTS (SIMULATED):

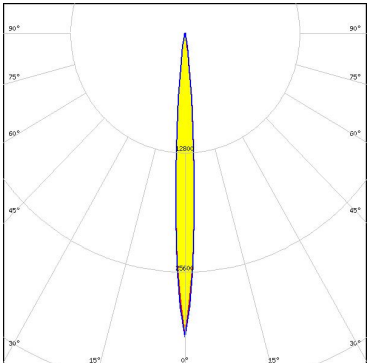
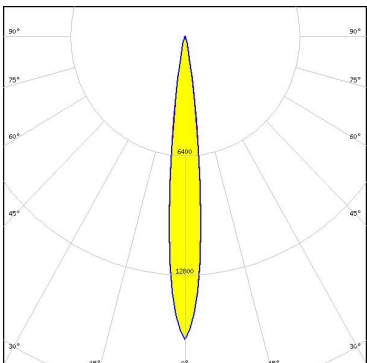
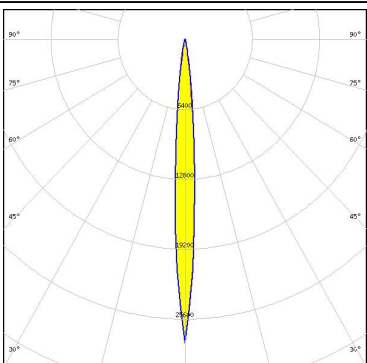
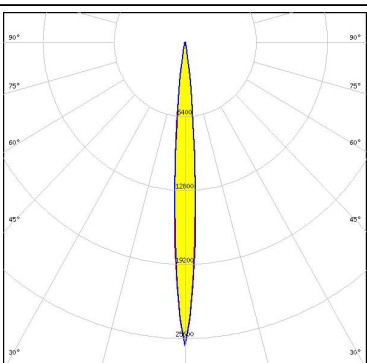
<p>NICHIA</p> <p>LED: NCSxE17A FWHM / FWTM: 8.0° / 16.0° Efficiency: 92 % Peak intensity: 32.5 cd/lm LEDs/each optic: 1 Light colour: White Required components:</p>	
<p>NICHIA</p> <p>LED: NVSW3x9A FWHM / FWTM: 12.0° / 22.0° Efficiency: 95 % Peak intensity: 16.3 cd/lm LEDs/each optic: 1 Light colour: White Required components:</p>	
<p>NICHIA</p> <p>LED: NVSxE21A FWHM / FWTM: 8.0° / 18.0° Efficiency: 94 % Peak intensity: 27.8 cd/lm LEDs/each optic: 1 Light colour: White Required components:</p>	
<p>NICHIA</p> <p>LED: NVSxE21A FWHM / FWTM: 8.0° / 18.0° Efficiency: 93 % Peak intensity: 26.2 cd/lm LEDs/each optic: 1 Light colour: White Required components:</p>	

OPTICAL RESULTS (SIMULATED):

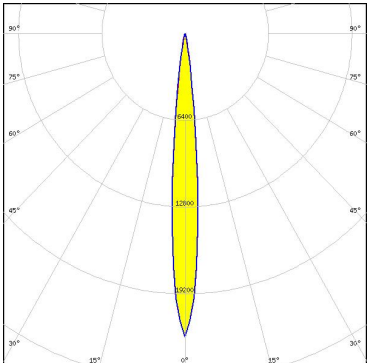
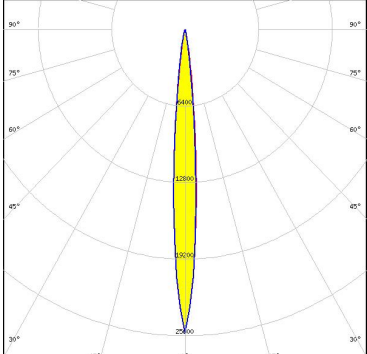
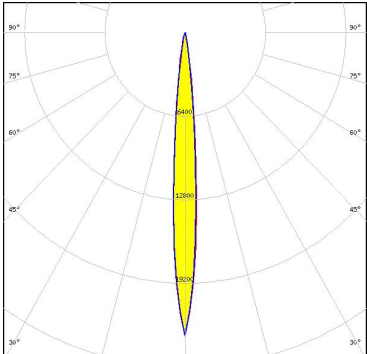
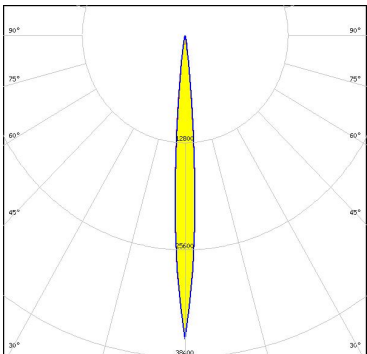
<p>NICHIA</p> <p>LED NVSxx19B/NVSxx19C FWHM / FWTM 10.0° / 18.0° Efficiency 95 % Peak intensity 22.4 cd/lm LEDs/each optic 1 Light colour White Required components:</p>	
<p>OSRAM Opto Semiconductors</p> <p>LED Duris S5 (Single chip) FWHM / FWTM 8.0° / 18.0° Efficiency 96 % Peak intensity 25.4 cd/lm LEDs/each optic 1 Light colour White Required components:</p>	
<p>OSRAM Opto Semiconductors</p> <p>LED Duris S5 (Single chip) FWHM / FWTM 9.0° / 18.0° Efficiency 89 % Peak intensity 23.2 cd/lm LEDs/each optic 1 Light colour Purple Required components:</p>	
<p>OSRAM Opto Semiconductors</p> <p>LED OSCONIQ C 2424 FWHM / FWTM 8.0° / 16.0° Efficiency 96 % Peak intensity 36.2 cd/lm LEDs/each optic 1 Light colour White Required components:</p>	

OPTICAL RESULTS (SIMULATED):

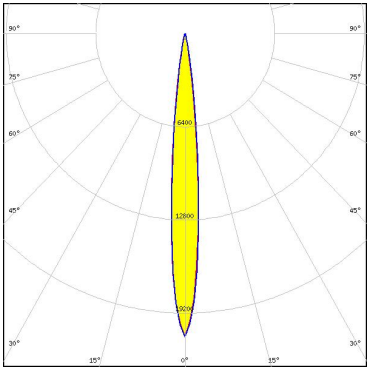
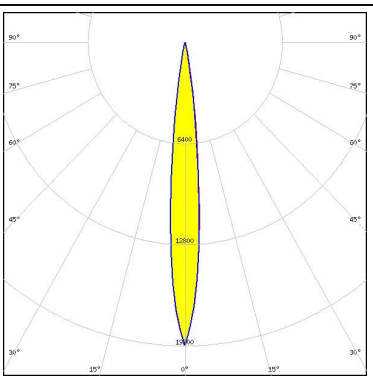
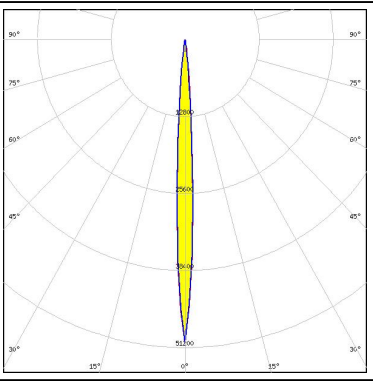
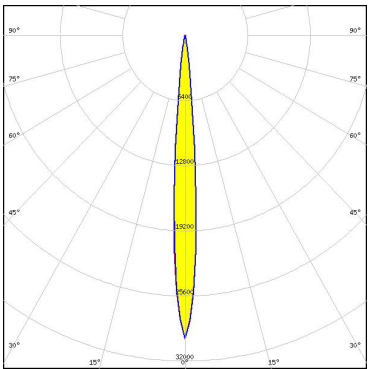
<p>OSRAM Opto Semiconductors</p> <p>LED OSCONIQ P 3030</p> <p>FWHM / FWTM 10.0° / 20.0°</p> <p>Efficiency 96 %</p> <p>Peak intensity 20.8 cd/lm</p> <p>LEDs/each optic 1</p> <p>Light colour White</p> <p>Required components:</p>	
<p>OSRAM Opto Semiconductors</p> <p>LED OSLON Black</p> <p>FWHM / FWTM 11.0° / 20.0°</p> <p>Efficiency 94 %</p> <p>Peak intensity 19.7 cd/lm</p> <p>LEDs/each optic 1</p> <p>Light colour White</p> <p>Required components:</p>	
<p>OSRAM Opto Semiconductors</p> <p>LED OSLON Black Flat (LUW HWQP)</p> <p>FWHM / FWTM 6.3° / 14.0°</p> <p>Efficiency 94 %</p> <p>Peak intensity 50.4 cd/lm</p> <p>LEDs/each optic 1</p> <p>Light colour White</p> <p>Required components:</p>	
<p>OSRAM Opto Semiconductors</p> <p>LED OSLON PURE 1010</p> <p>FWHM / FWTM 8.0° / 16.0°</p> <p>Efficiency 93 %</p> <p>Peak intensity 29.8 cd/lm</p> <p>LEDs/each optic 1</p> <p>Light colour White</p> <p>Required components:</p>	

OPTICAL RESULTS (SIMULATED):

OSRAM

Opto Semiconductors

LED OSLOM Square CSSRM2/CSSRM3
 FWHM / FWTM 11.0° / 21.0°
 Efficiency 94 %
 Peak intensity 19.4 cd/lm
 LEDs/each optic 1
 Light colour White
 Required components:

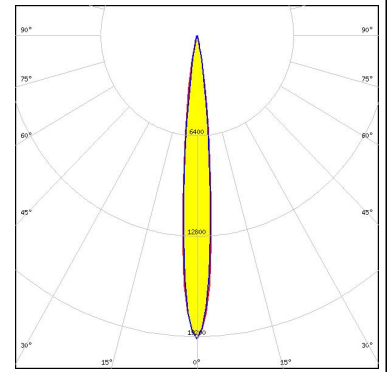

OSRAM

Opto Semiconductors

LED OSLOM SSL 120
 FWHM / FWTM 7.0° / 14.0°
 Efficiency 96 %
 Peak intensity 45.5 cd/lm
 LEDs/each optic 1
 Light colour Amber
 Required components:

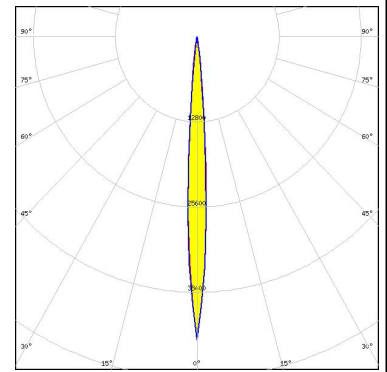

OSRAM

Opto Semiconductors

LED OSLOM SSL 150
 FWHM / FWTM 7.0° / 14.0°
 Efficiency 96 %
 Peak intensity 44.5 cd/lm
 LEDs/each optic 1
 Light colour Amber
 Required components:

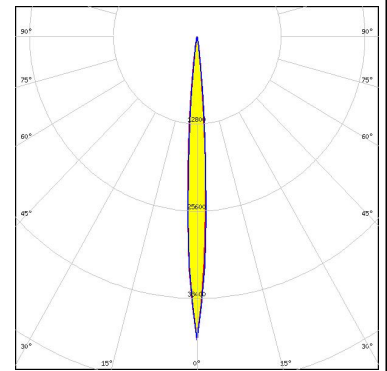

OSRAM

Opto Semiconductors

LED OSLOM SSL 150
 FWHM / FWTM 6.0° / 14.0°
 Efficiency 96 %
 Peak intensity 47.7 cd/lm
 LEDs/each optic 1
 Light colour White
 Required components:

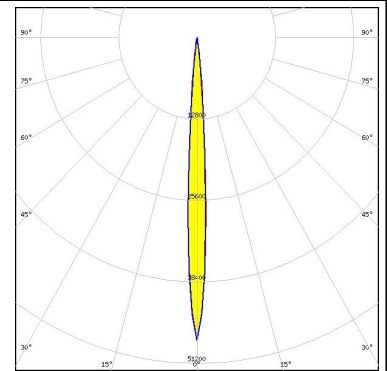

OPTICAL RESULTS (SIMULATED):

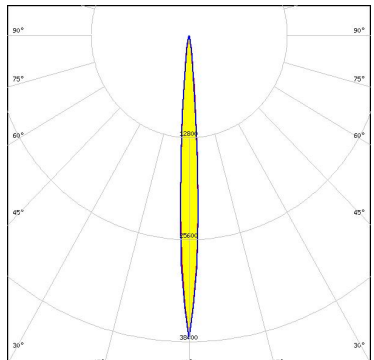
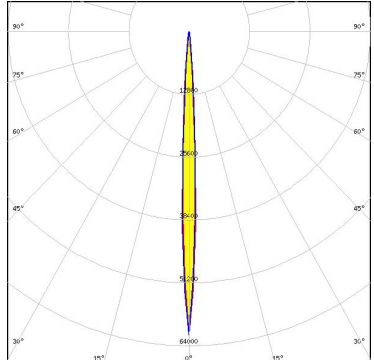
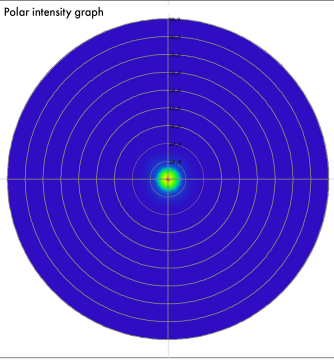
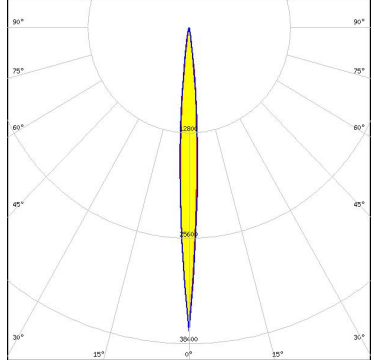
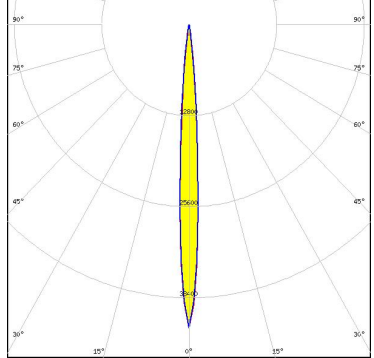
<p>OSRAM Opto Semiconductors</p> <p>LED: OSLOM SSL 80</p> <p>FWHM / FWTM: 7.0° / 14.0°</p> <p>Efficiency: 94 %</p> <p>Peak intensity: 38 cd/lm</p> <p>LEDs/each optic: 1</p> <p>Light colour: White</p> <p>Required components:</p>		
<p>OSRAM Opto Semiconductors</p> <p>LED: SFH 4170S</p> <p>FWHM / FWTM: 6.0° / 11.0°</p> <p>Efficiency: 87 %</p> <p>LEDs/each optic: 1</p> <p>Light colour: IR</p> <p>Required components:</p>		
<p>OSRAM Opto Semiconductors</p> <p>LED: SFH 4715AS</p> <p>FWHM / FWTM: 6.0° / 16.0°</p> <p>Efficiency: 96 %</p> <p>LEDs/each optic: 1</p> <p>Light colour: IR</p> <p>Required components:</p>	<p>Polar intensity graph</p> 	
<p>OSRAM Opto Semiconductors</p> <p>LED: SFH 4716AS</p> <p>FWHM / FWTM: 8.0° / 14.0°</p> <p>Efficiency: 96 %</p> <p>LEDs/each optic: 1</p> <p>Light colour: IR</p> <p>Required components:</p>		

OPTICAL RESULTS (SIMULATED):

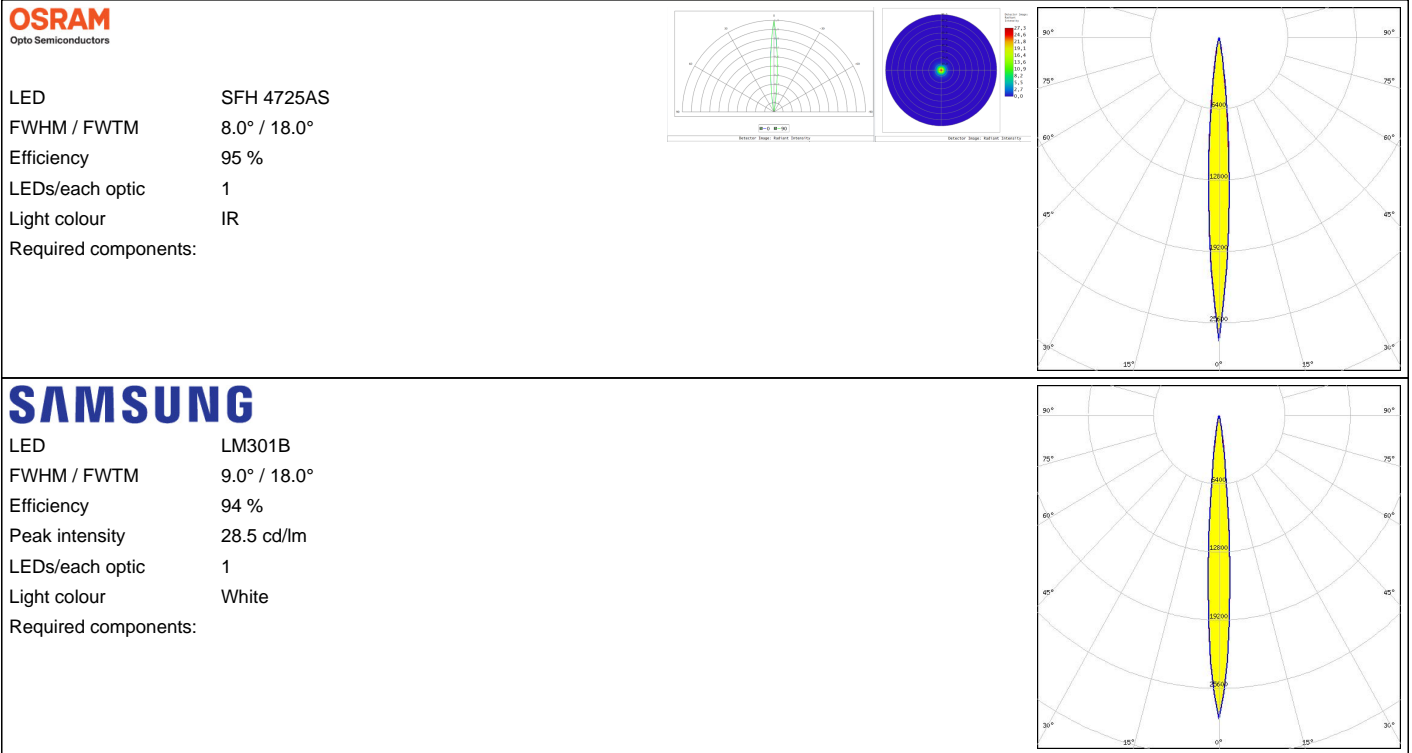

GENERAL INFORMATION:

NOTE: The typical beam angle will be changed by different color, chip size and chip position tolerance. The typical total beam angle is the full angle measured where the luminous intensity is half of the peak value.

MATERIALS:

As part of our continuous research and improvement processes, and to ensure the best possible quality and availability of our products, LEDiL reserves the right to change material grades without notice.

PRODUCT DATA USER AGREEMENT AND DISCLAIMER:

The measured data in the provided downloadable LEDiL Product Datasheets and Mechanical 2D-Drawings is rounded and provided as reference for planning. LEDiL Oy's optical specifications have been verified by conducting performance testing of the products in accordance with the company's quality system. The reported data are averaged results of multiple measurements with typical variation. LEDiL Oy reserves the right to without prior notification make changes and improvements to its products.

LEDiL Oy assumes neither warranty, nor guarantee nor any other liability of any kind for the contents and correctness of the provided data. The provided data has been generated with highest diligence but the provided data may in reality not represent the complete possible variation range of all intrinsic parameters. Therefore, in certain cases a deviation from the provided data could occur.

LEDiL Oy reserves the right to undertake technical changes of its products without further notification which could lead to changes in the provided data. LEDiL Oy assumes no liability of any kind for the possible deviation from any provided data or any other damage resulting from the usage of the provided data.

The user agrees to this disclaimer and user agreement with the download or usage of the provided files.

LEDiL Oy

Joensuunkatu 13
FI-24240 SALO
Finland

LEDiL Inc.

228 West Page Street
Suite D
Sycamore IL 60178
USA

Ledil Optics Technology (Shenzhen) Co., Ltd.

405 , Block B
Casic Motor Building
Shenzhen 518057
P.R.CHINA

Local sales and technical support

[www.ledil.com/
where_to_buy](http://www.ledil.com/where_to_buy)

Shipping locations

Salo, Finland
Hong Kong, China

Distribution Partners

[www.ledil.com/
where_to_buy](http://www.ledil.com/where_to_buy)