

DETAILS

Product Number	C15035_STRADELLA-8-T3
Family	Stradella
Type	Lens array
Color	clear
Diameter	49,5+49,5 mm
Height	5,7 mm
Style	rectang
Optic Material	PMMA
Holder Material	
Fastening	pin, screw
Status	production ready
ROHS Compliant	Yes
Date Updated	28/12/2016



OPTICAL PROPERTIES

LED	Viewing	Light	Effi-		Connector
	Angle	Beam	ciency	cd/lm	
QUICK FLUX XT 2x8 xxx STRDLL G5	Asymmetric deg	Asymmetric	94 %	0.590	-
XT-E	Asymmetric deg	Asymmetric	96 %	0.620	-
XP-G2	sim: Asymmetric	Asymmetric	sim: 91 %	sim: 0.600	-
XP-G3	sim: Asymmetric	Asymmetric	sim: 89 %	sim: 0.510	-
LUXEON 3535 2D	sim: Asymmetric	Asymmetric	sim: 94 %	sim: 0.650	-
LUXEON 3030 2D	Asymmetric deg	Asymmetric	94 %	0.800	-
LUXEON TX	Asymmetric deg	Asymmetric	94 %	0.680	-
NF2x757D	sim: Asymmetric	Asymmetric	sim: 95 %	sim: 0.800	-
NVSxx19B/NVSxx19C	sim: Asymmetric	Asymmetric	sim: 94 %	sim: 0.580	-
NCSxE17A	sim: Asymmetric	Asymmetric	sim: 93 %	sim: 0.900	-
NVSxE21A	sim: Asymmetric	Asymmetric	sim: 94 %	sim: 0.940	-
Oslon Square EC	sim: Asymmetric	Asymmetric	sim: 93 %	sim: 0.700	-
Duris S5 (2 chip)	sim: Asymmetric	Asymmetric	sim: 95 %	sim: 0.740	-
OSCONIQ P 3737 (2W version)	sim: Asymmetric	Asymmetric	sim: 61 %	sim: 0.320	-
OSCONIQ P 3737 (3W version)	sim: Asymmetric	Asymmetric	sim: 94 %	sim: 0.500	-
Oslon Square PC	sim: Asymmetric	Asymmetric	sim: 85 %	sim: 0.410	Undefined Manufacturer: Protective Plate, Glass
LH351C	sim: Asymmetric	Asymmetric	sim: 93 %	sim: 0.510	-
Z8Y19	Asymmetric deg	Asymmetric	94 %	0.800	-
Z8Y22	Asymmetric deg	Asymmetric	94 %	sim: 0.000	-
Z8Y22P	Asymmetric deg	Asymmetric	94 %	0.600	-

H G F E D C B A

4

3

2

1

4

3

2

1

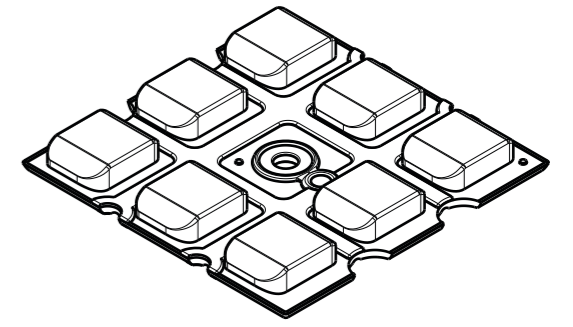
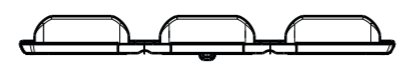

Light direction

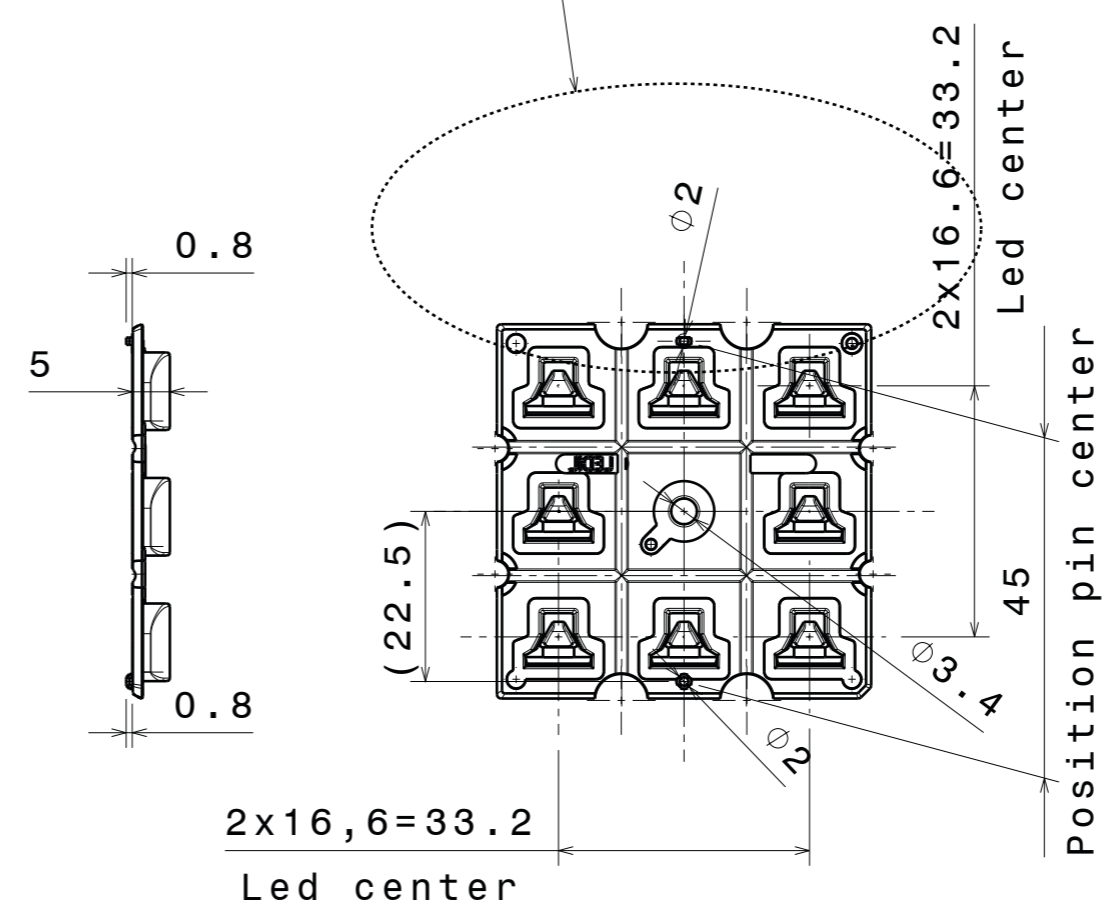
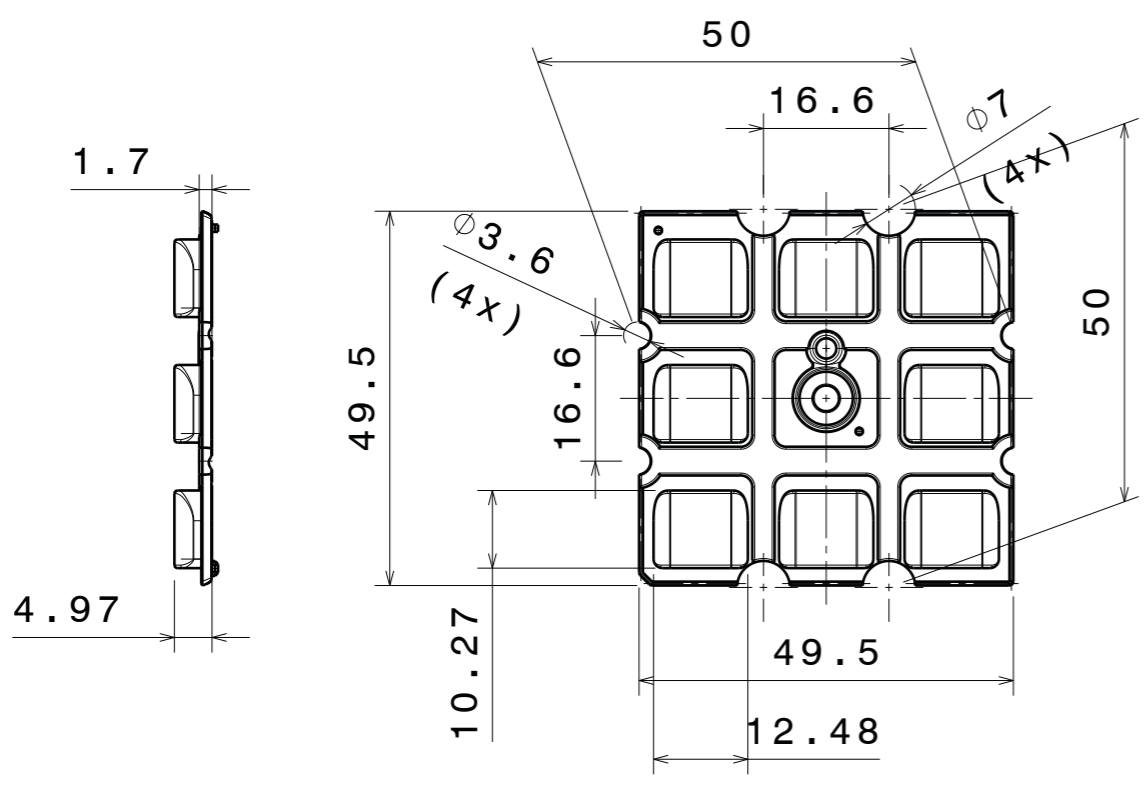

Recommended fixing screw torque 0,6Nm

INDEX	PART NO	DESCRIPTION	MATERIAL	COLOUR
1	C15035	STRADELLA-8-T3	PMMA	Clear

Tolerances if not otherwise shown
 According to DIN ISO 2768-1
 Linear measures:
 up to 30mm class M, otherwise class C
 According to DIN ISO 2768-2
 Form and position: class L

LEDiL Ledil Oy
 Salorankatu 10
 FIN 24240 SALO
 Finland

THIRD ANGLE PROJECTION:

DRAWING TITLE
C15035_STRADELLA-8-T3

This drawing is the property of LEDiL Oy. It may not be reproduced, copied or communicated without a written agreement with LEDiL Oy.

SIZE **A3** PART NUMBER **C15035**

SCALE 1:1 WEIGHT 6,0 SHEET 1/1

H G F E D C B A

Luminaire: Ledil C15035_STRADELLA-8-T3_(QUICK-FLUX-EngXP-750-StrdII16)

Lamps: 1 x Cree_XT-E-HE_QUICK-FLUX-EngXP-750-StrdII16_1847.62lm@250mA_P=11.5481W_η=0.25A

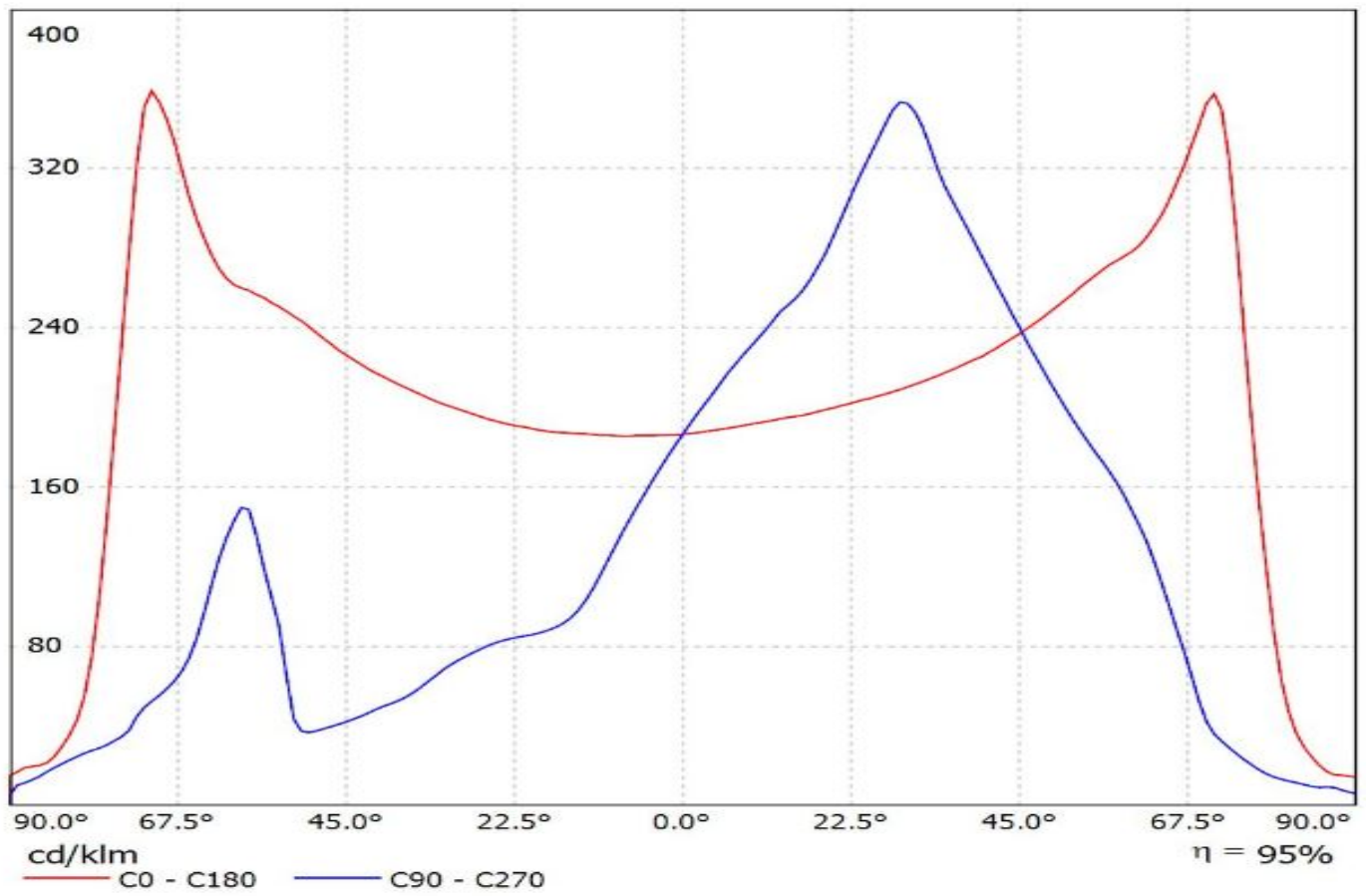

Luminaire: Ledil C15035_STRADELLA-8-T3_(XT-E)

Lamps: 1 x Cree_XT-E_x8_(XTEAWT-0-2A0-R30-FB0001)_801.566lm@250mA_P=5.9775W_I=0.25A

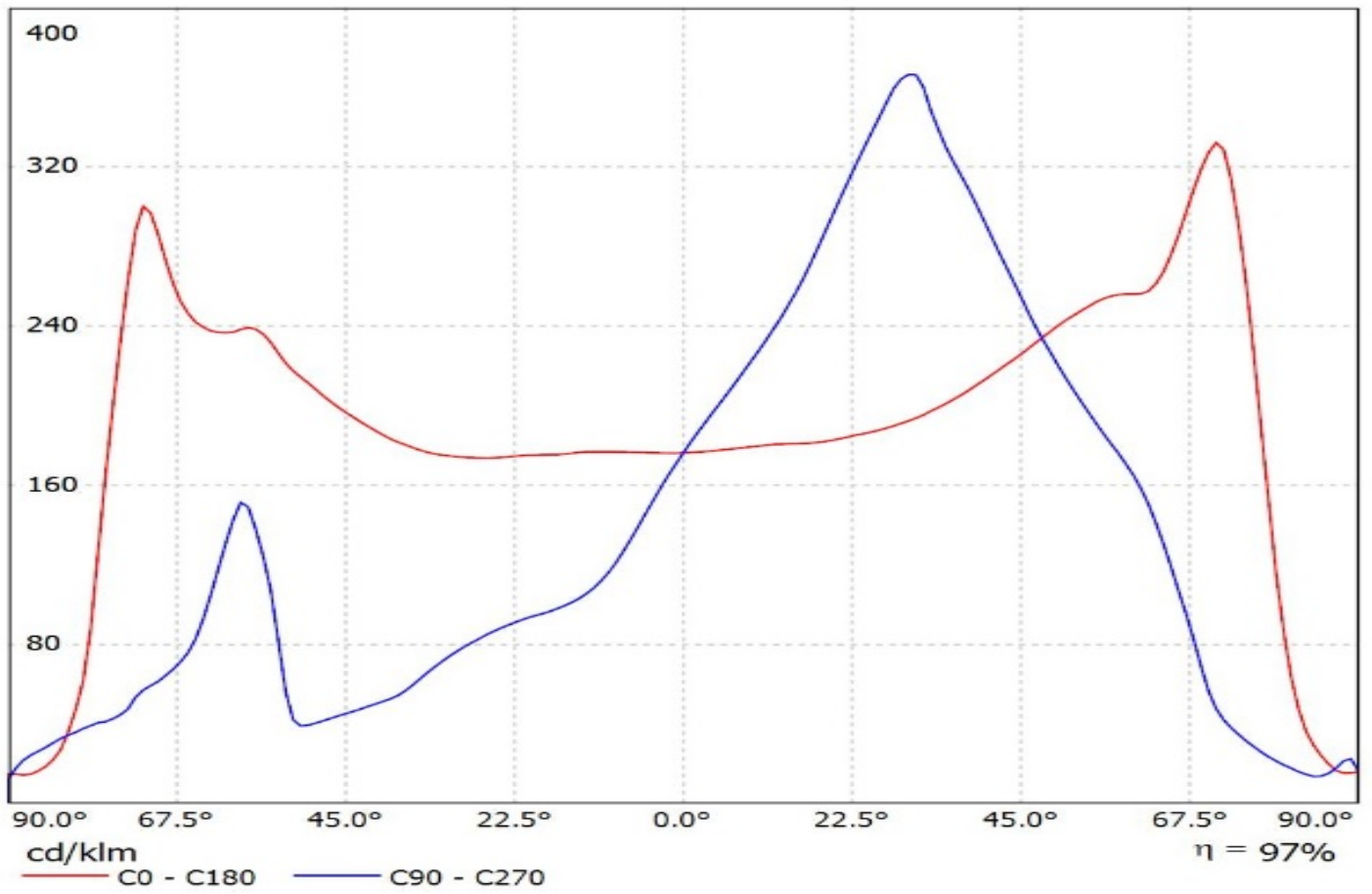

Luminaire: Ledil Oy C15035_STRADELLA-8-T3_(XP-G3)_SIMULATED
Lamps: 1 x Cree XP-G3

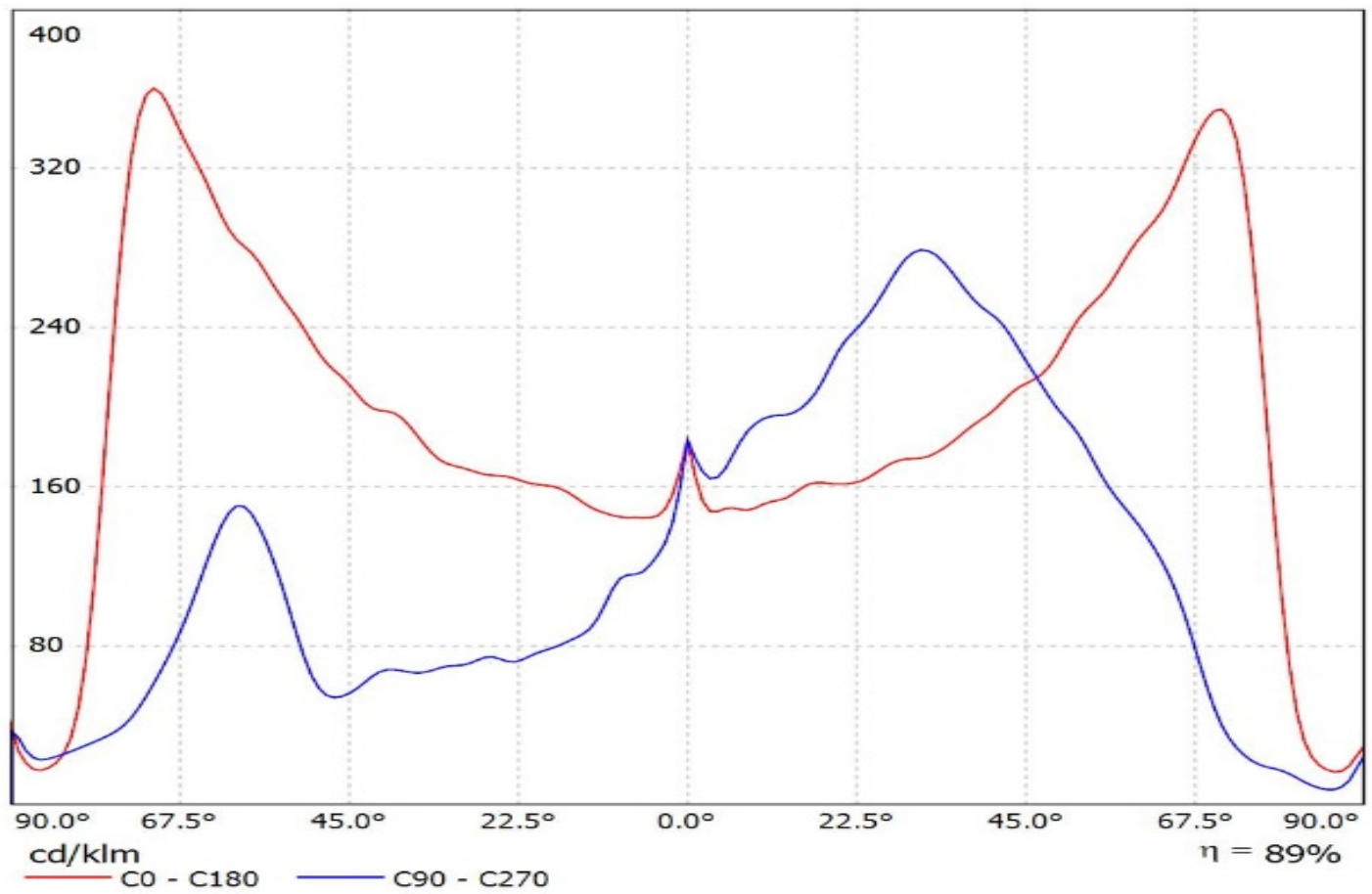

Luminaire: LEDiL Oy C15035_STRADELLA-8-T3_(Luxeon_3030_2D)

Lamps: 1 x Luxeon_3030_2D_x8_(LI30-2780)_335.042lm@60mA_P=2.7141W_I=0.06A

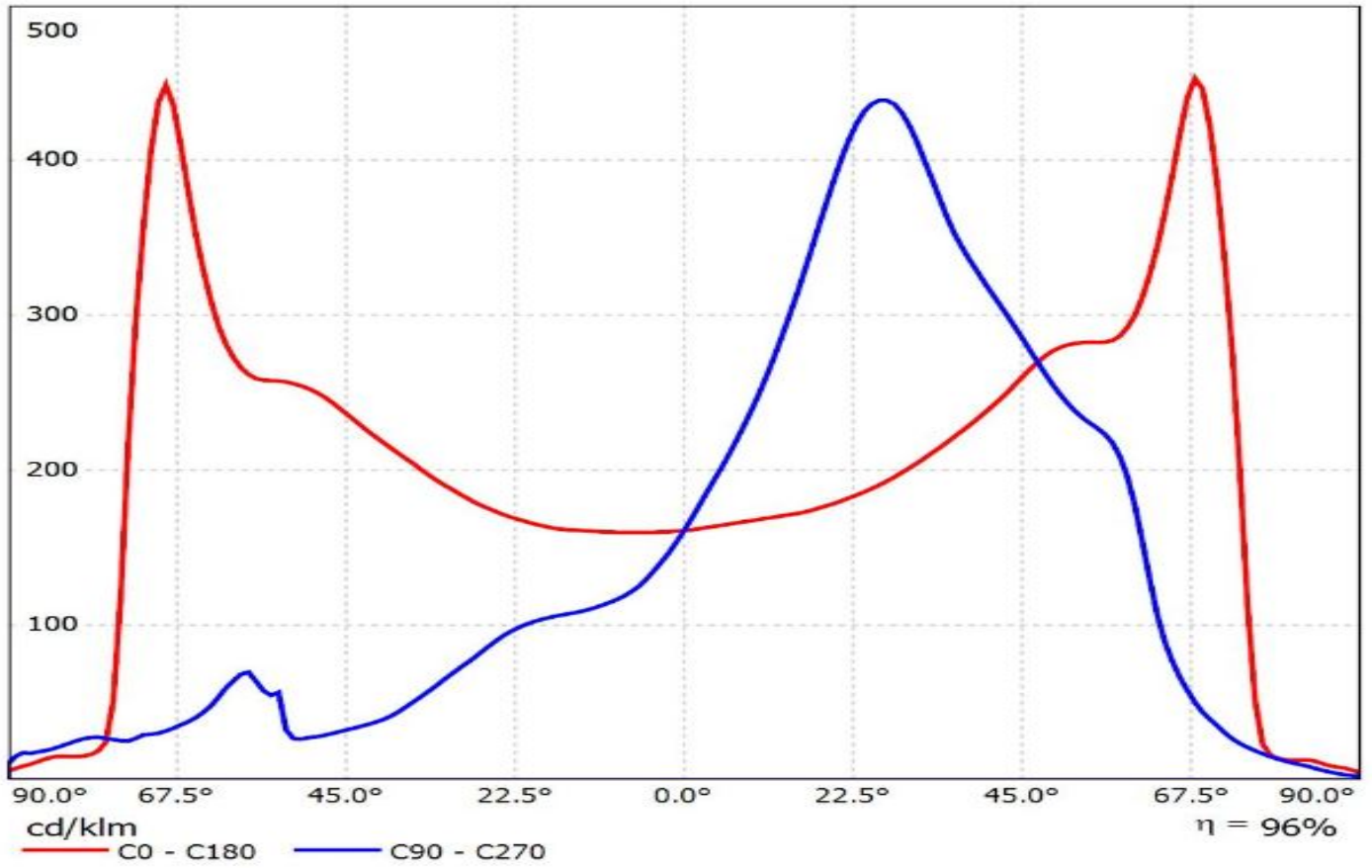

Luminaire: Ledil Oy C15035_STRADELLA-8-T3_NICHIA_NVSW219C_SIMULATED
Lamps: 1 x NICHIA NVSW219C

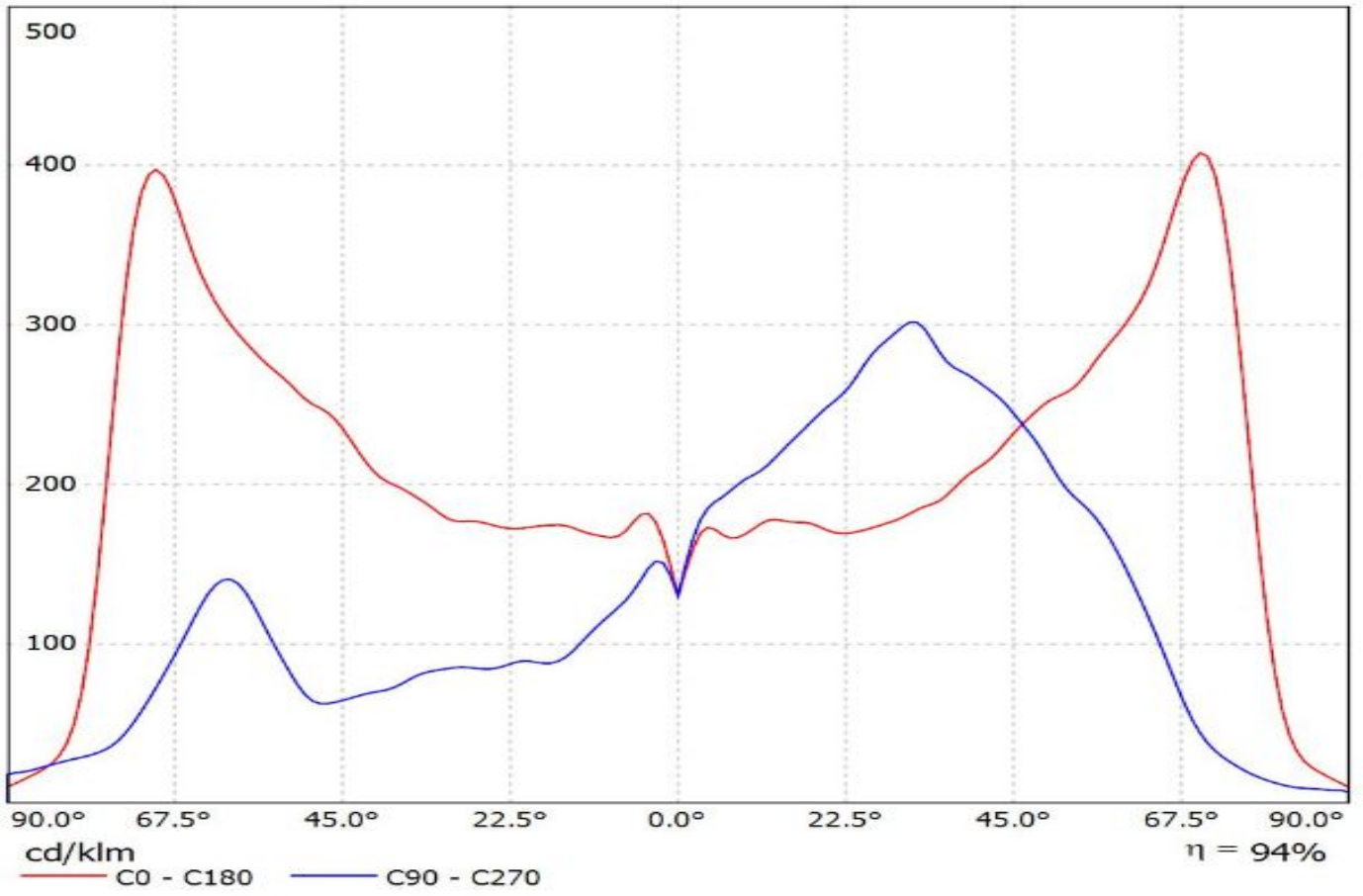

Luminaire: Ledil Oy C15035_STRADELLA-8-T3_(NCSxE17A)_SIMULATED
Lamps: 1 x NCSWE17A

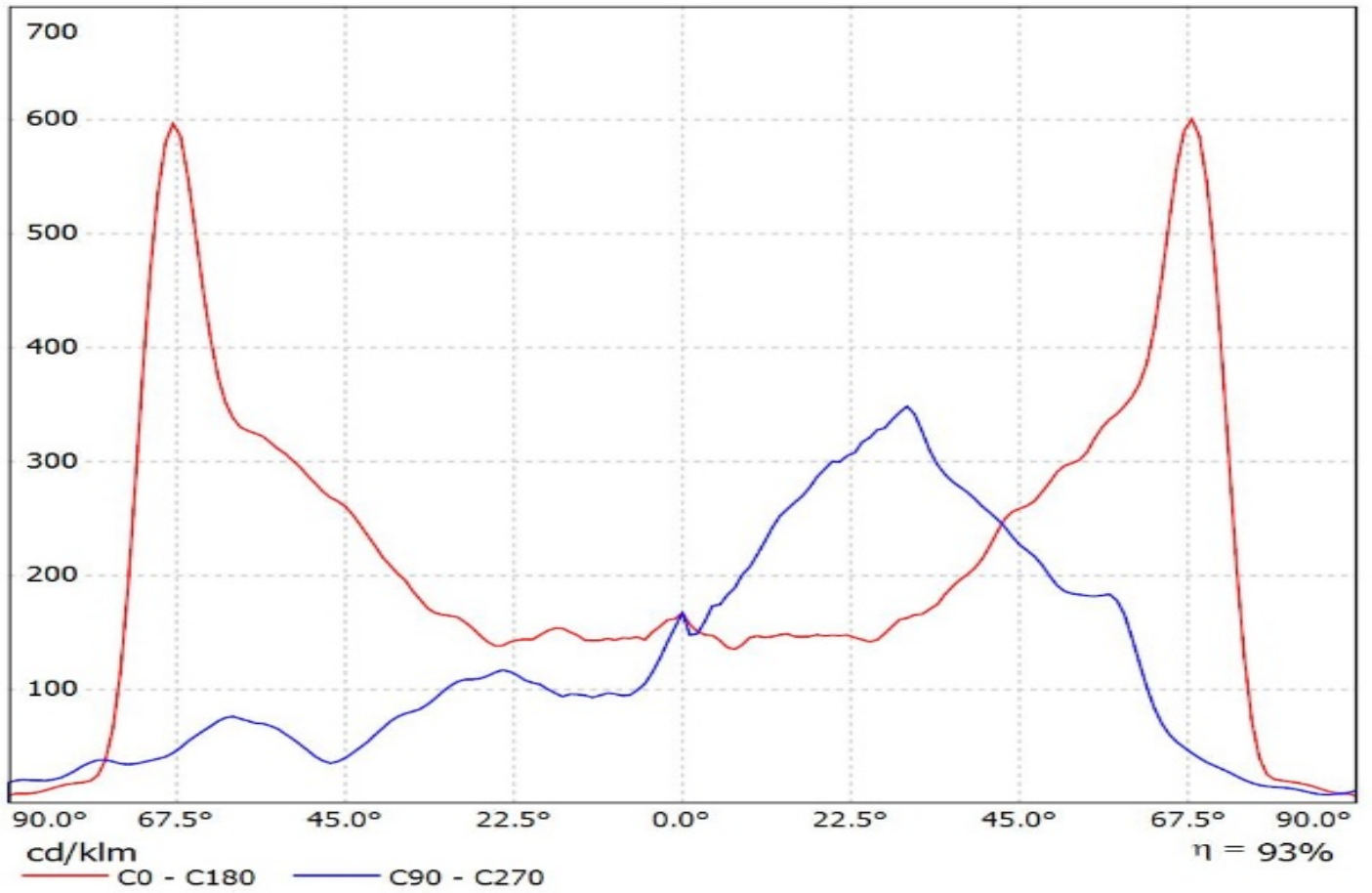

Luminaire: Ledil Oy C15035_STRADELLA-8-T3_NVSE21AT_SIMULATED
Lamps: 1 x NICHIA NVSE21AT

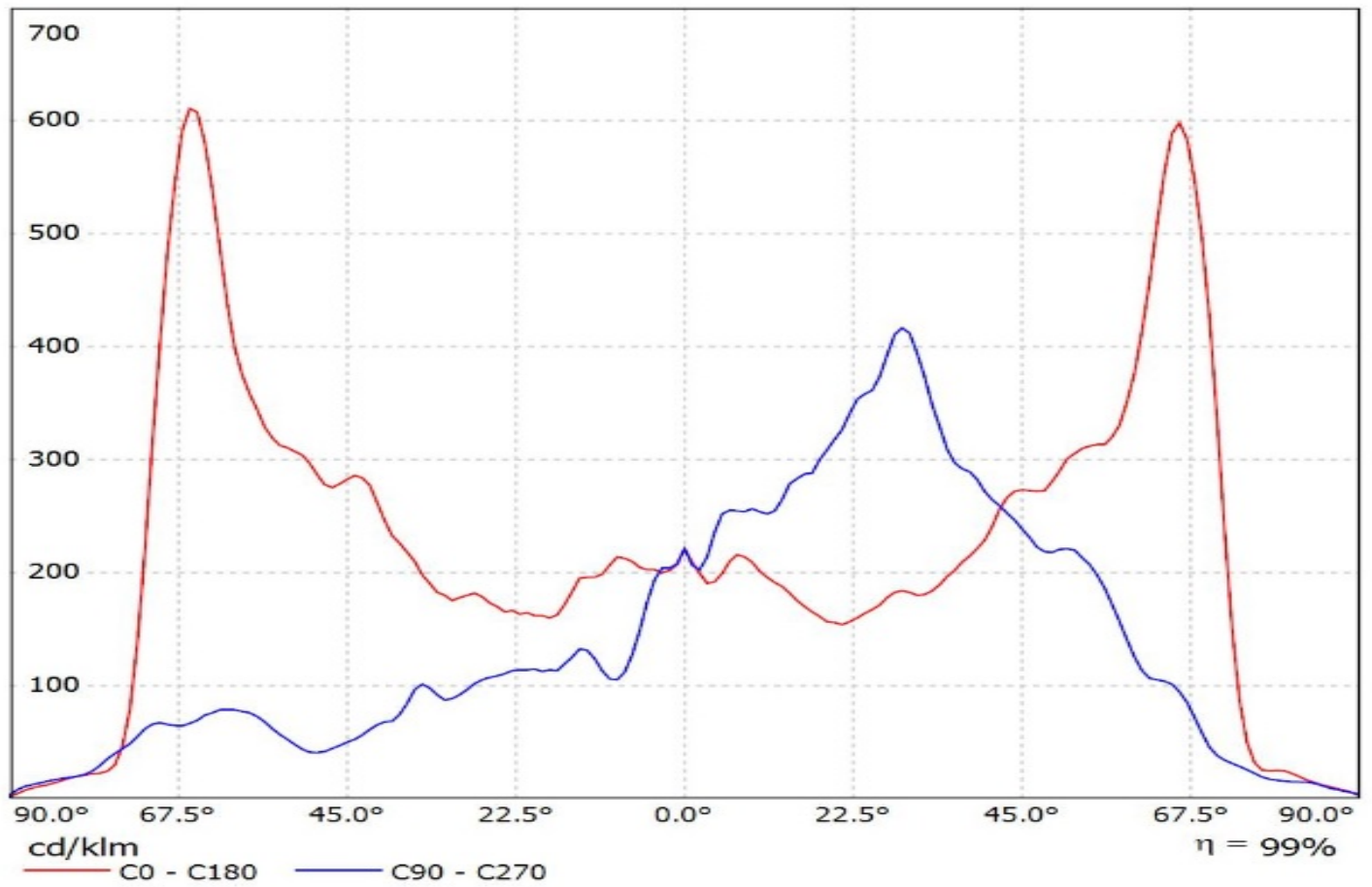

Luminaire: Ledil Oy C15035_STRADELLA-8-T3_SIMULATED
Lamps: 1 x Osram_OSCONIQ_P_3737_(2W_version)

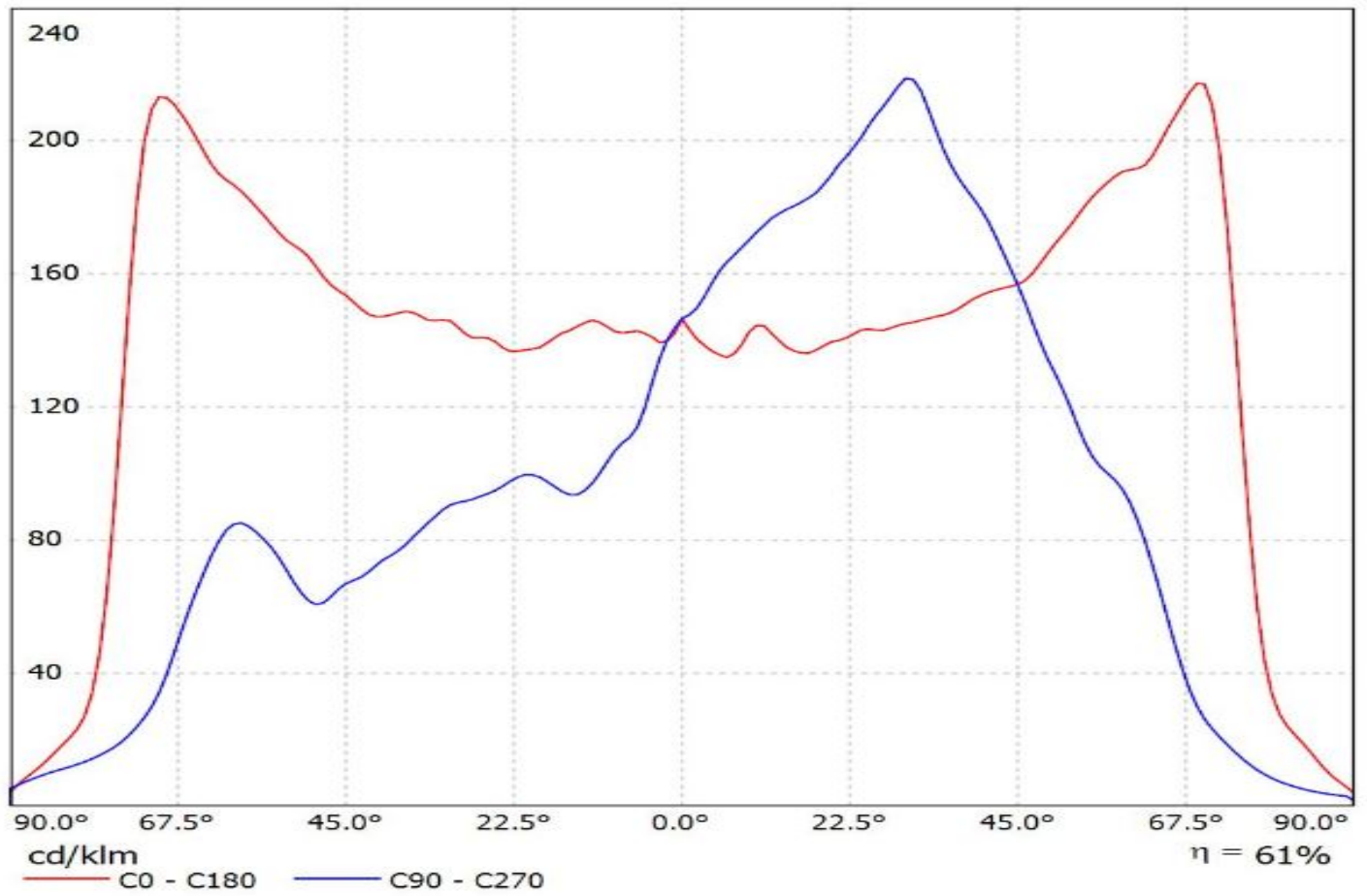

Luminaire: Ledil Oy C15035_STRADELLA-8-T3_SIMULATED
Lamps: 1 x Osram_OSCONIQ_P_3737_(3W_version)

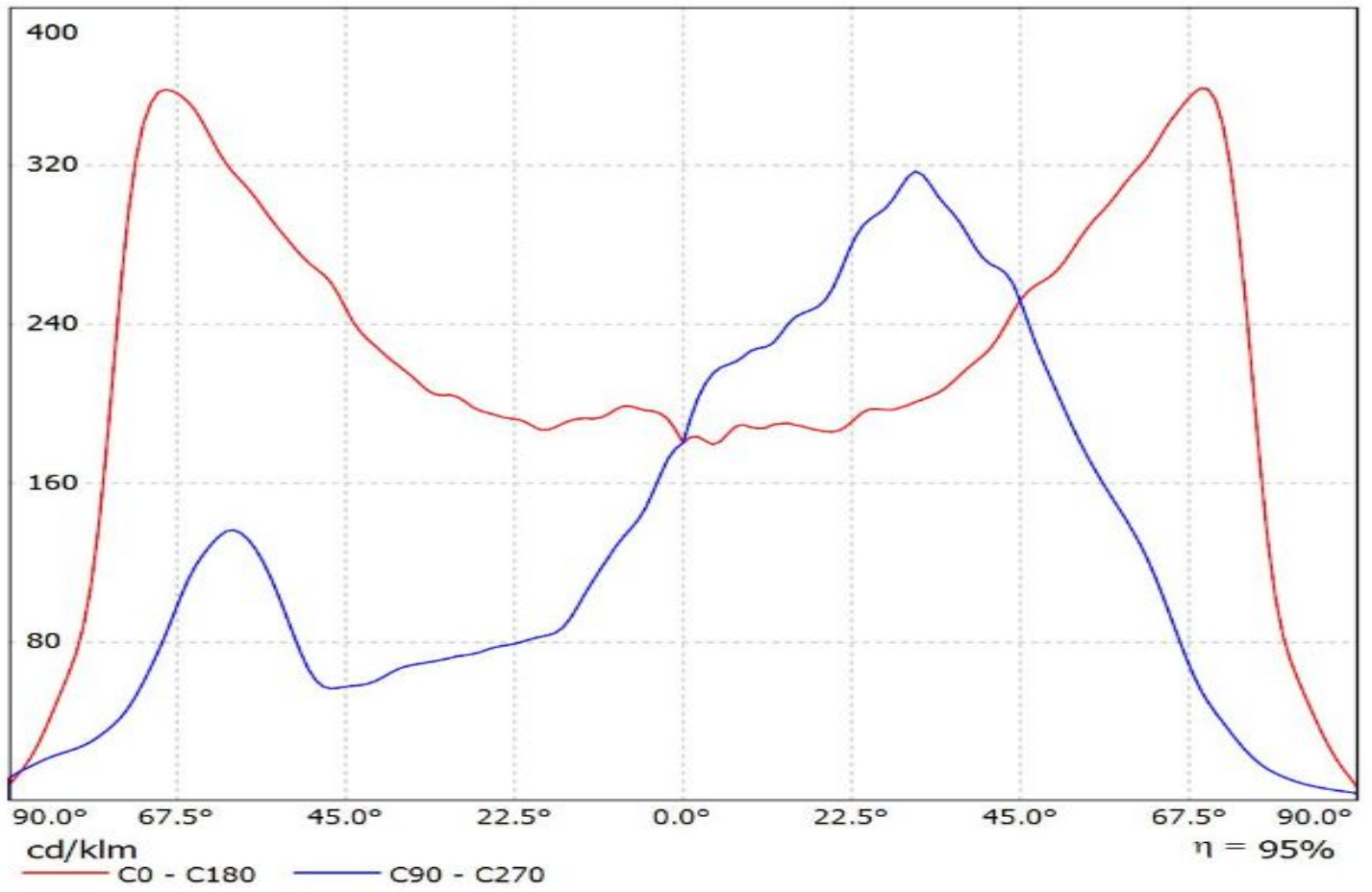

Luminaire: Ledil Oy C15035_STRADELLA-8-T3_(Osram_Oslon Square PC)_(Glass)_SIMULATED
Lamps: 1 x Osram_Oslon Square PC

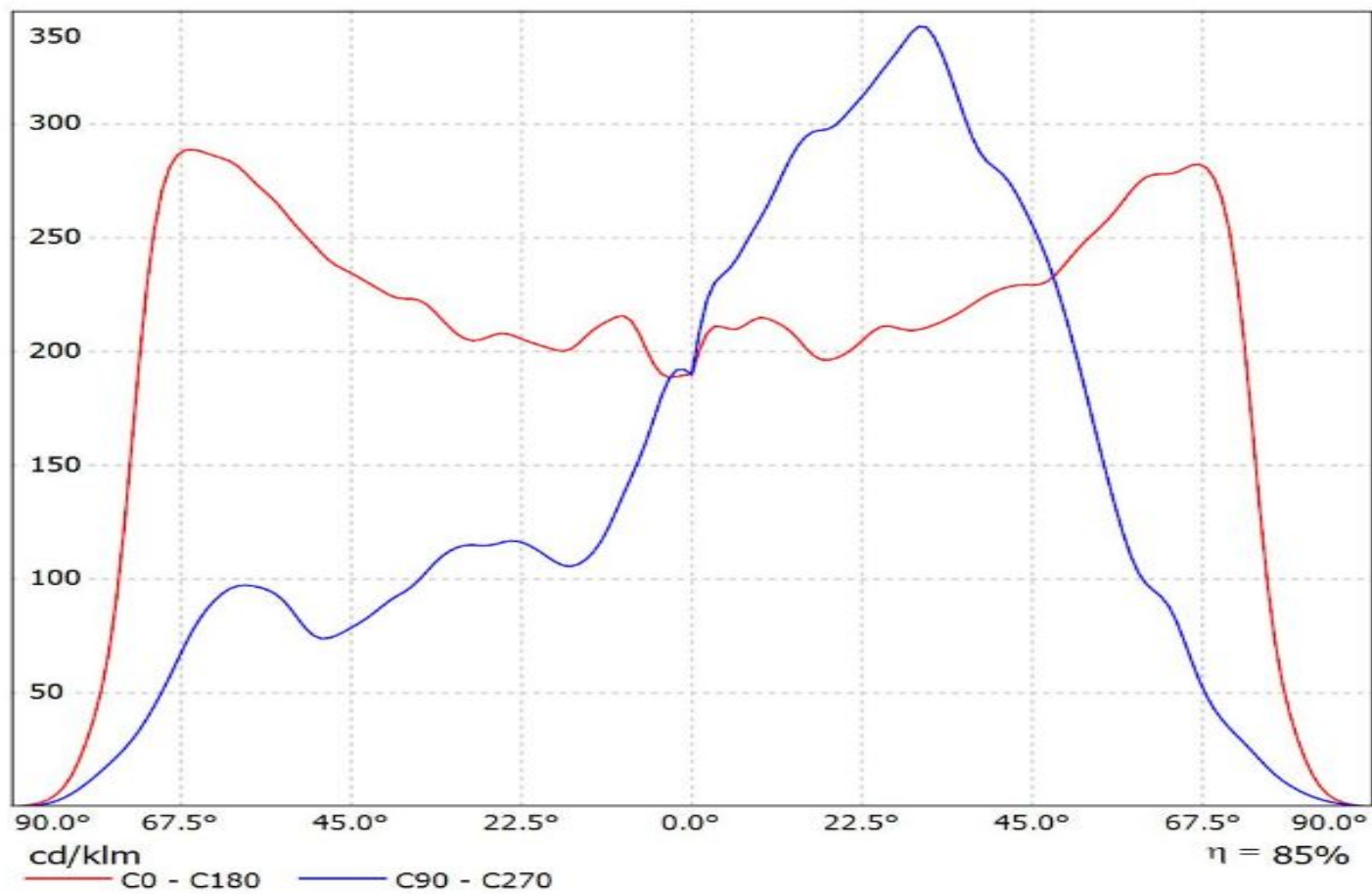

Luminaire: Ledil Oy C15035_STRADELLA-8-T3_(LH351C)_SIMULATED
Lamps: 1 x Samsung LH351C

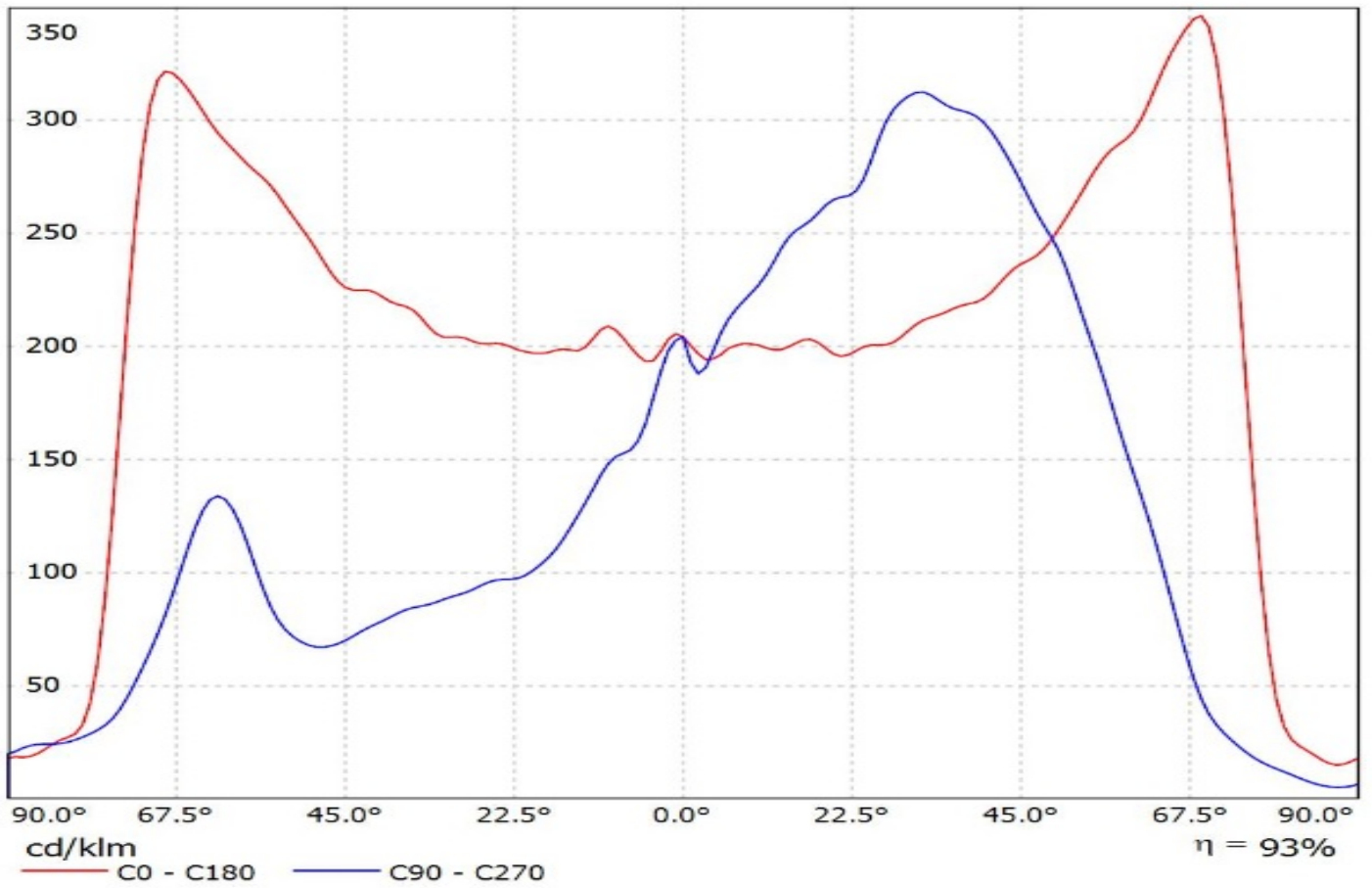

Luminaire: LEDiL Oy C15035_STRADELLA-8-T3_(SZ8-Y19)

Lamps: 1 x Seoul_SZ8-Y19_(SZ8-Y19-W0-C7)_940.325lm@250mA_P=5.59177W_I=0.250A

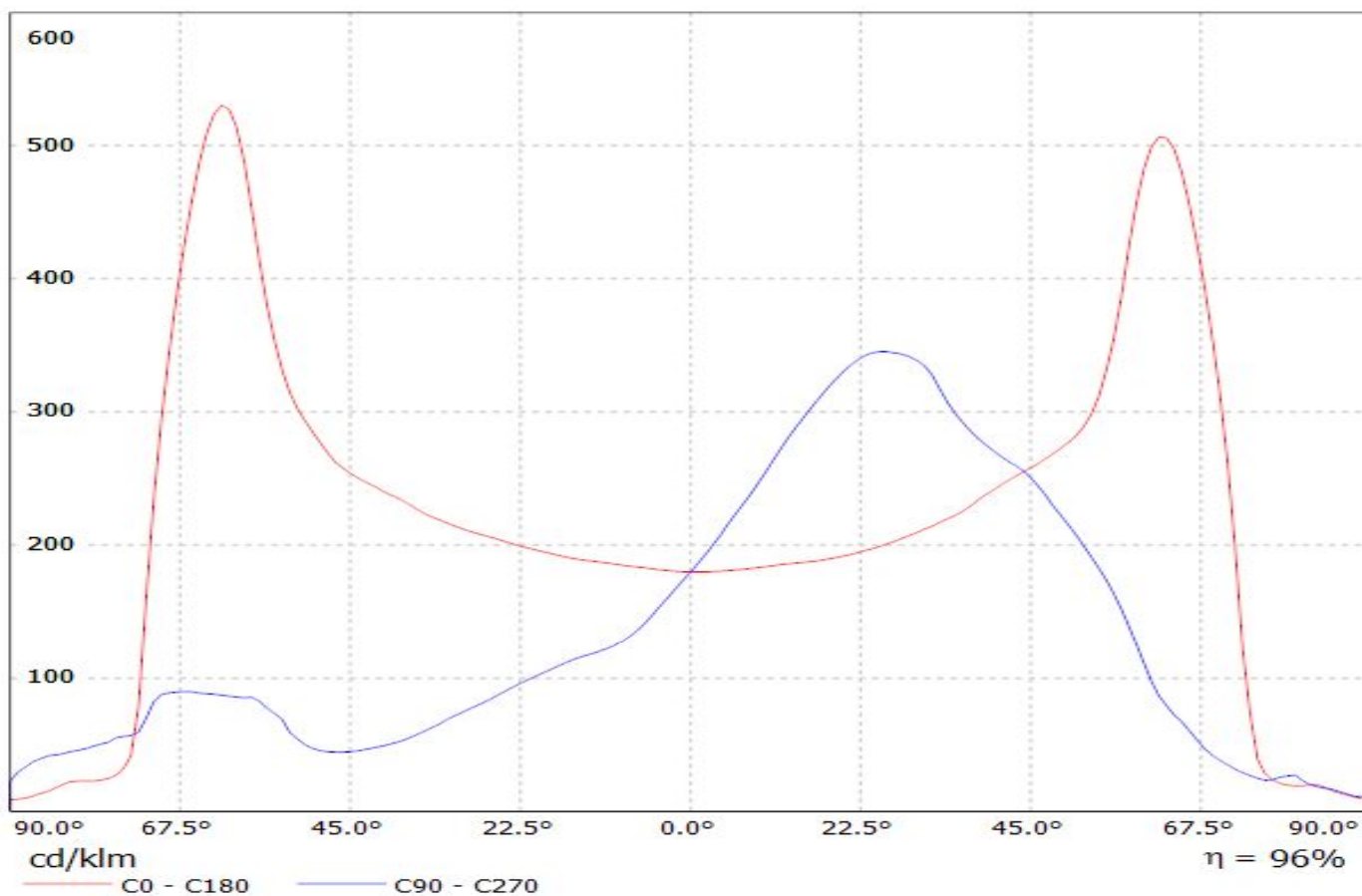

Luminaire: LEDiL Oy C15035_STRADELLA-8-T3_(SZ8_Y22)

Lamps: 1 x Seoul_SZ8_Y22_(SZ8-Y22-W0-C7)_1002.11lm@250mA_P=5.42341W_I=0.250A

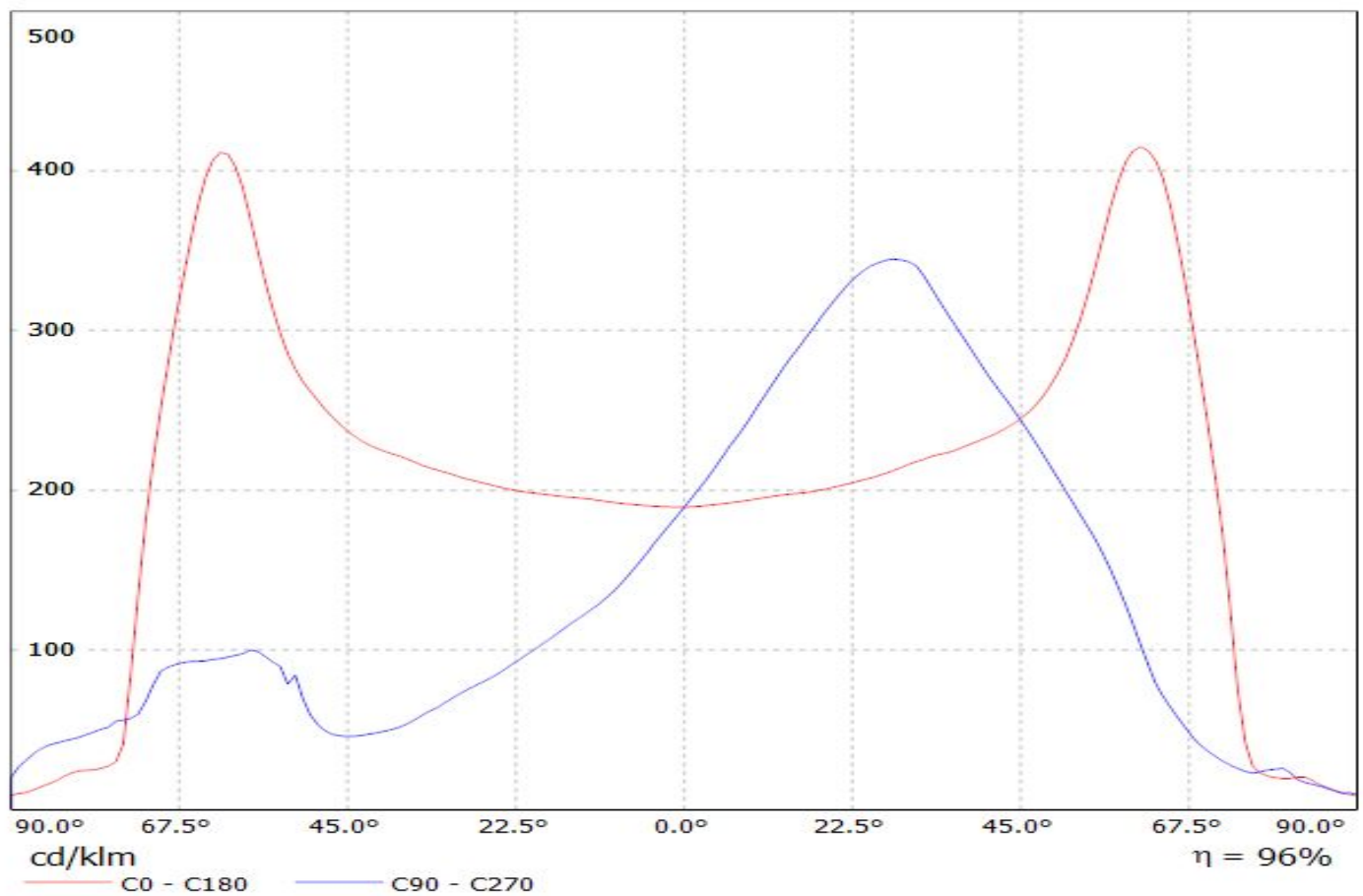

Luminaire: LEDiL Oy C15035_STRADELLA-8-T3 (Z8Y22P)
Lamps: 1 x Seoul_SZ8-Y22P_(SZ8-Y22-W0-C7-P)_957.081lm@250mA_P=5.49085W_I=0.25A

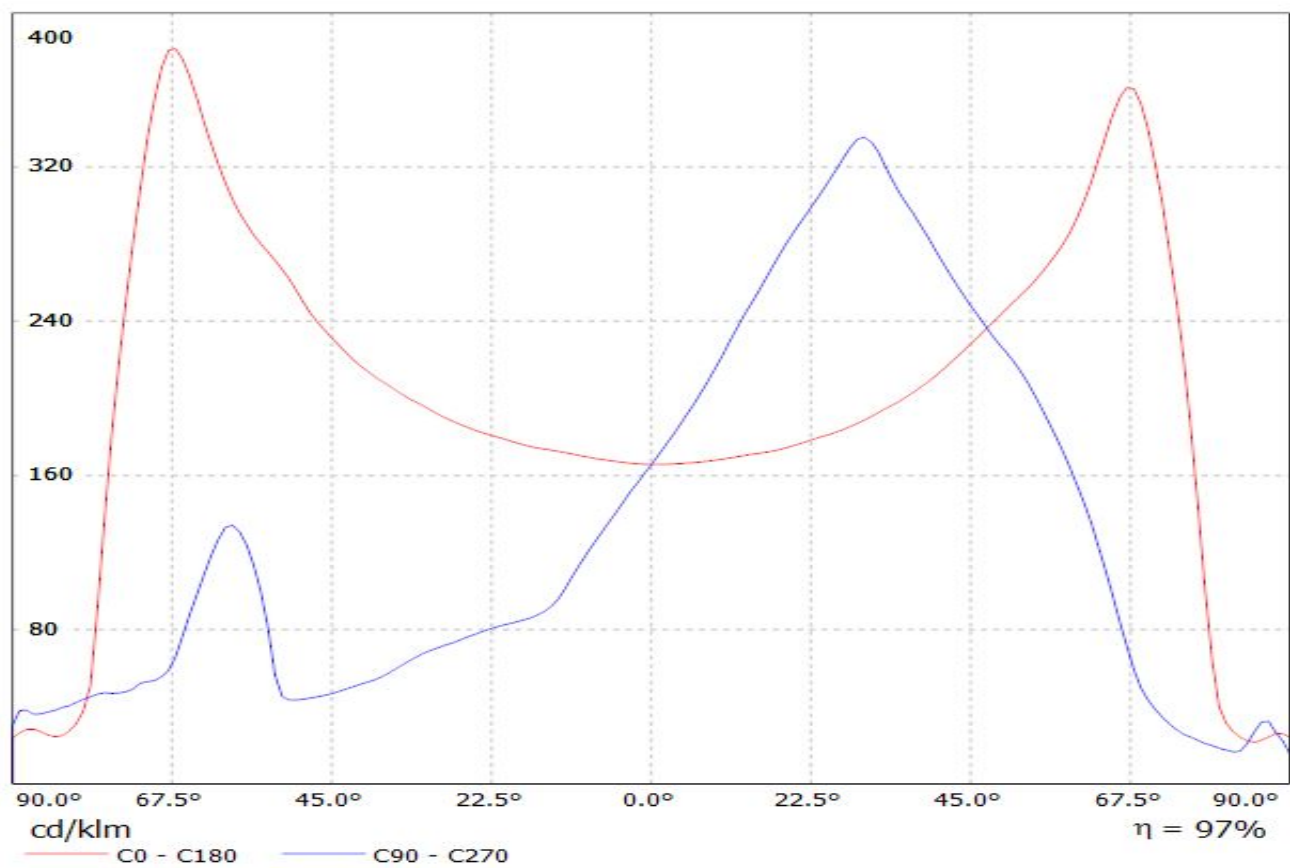

Luminaire: Ledil C15035_STRADELLA-8-T3_(QUICK-FLUX-EngXP-750-StrdII16)

Lamps: 1 x Cree_XT-E-HE_QUICK-FLUX-EngXP-750-StrdII16_1847.62lm@250mA_P=11.5481W_I=0.25A

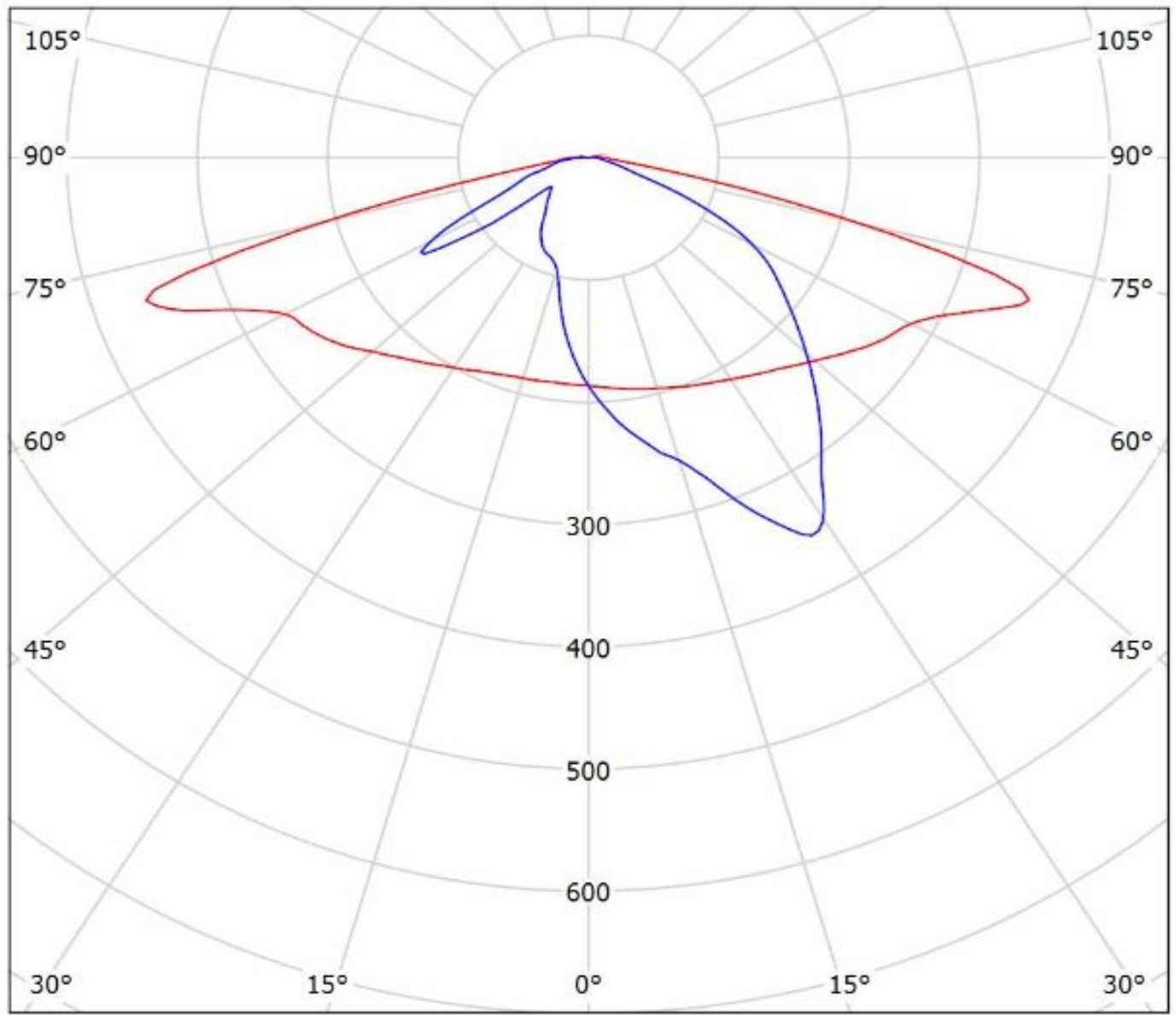

cd/klm

— C0 - C180

— C90 - C270

$\eta = 95\%$

Luminaire: Ledil C15035_STRADELLA-8-T3_(XT-E)

Lamps: 1 x Cree_XT-E_x8_(XTEAWT-0-2A0-R30-FB0001)_801.566lm@250mA_P=5.9775W_I=0.25A

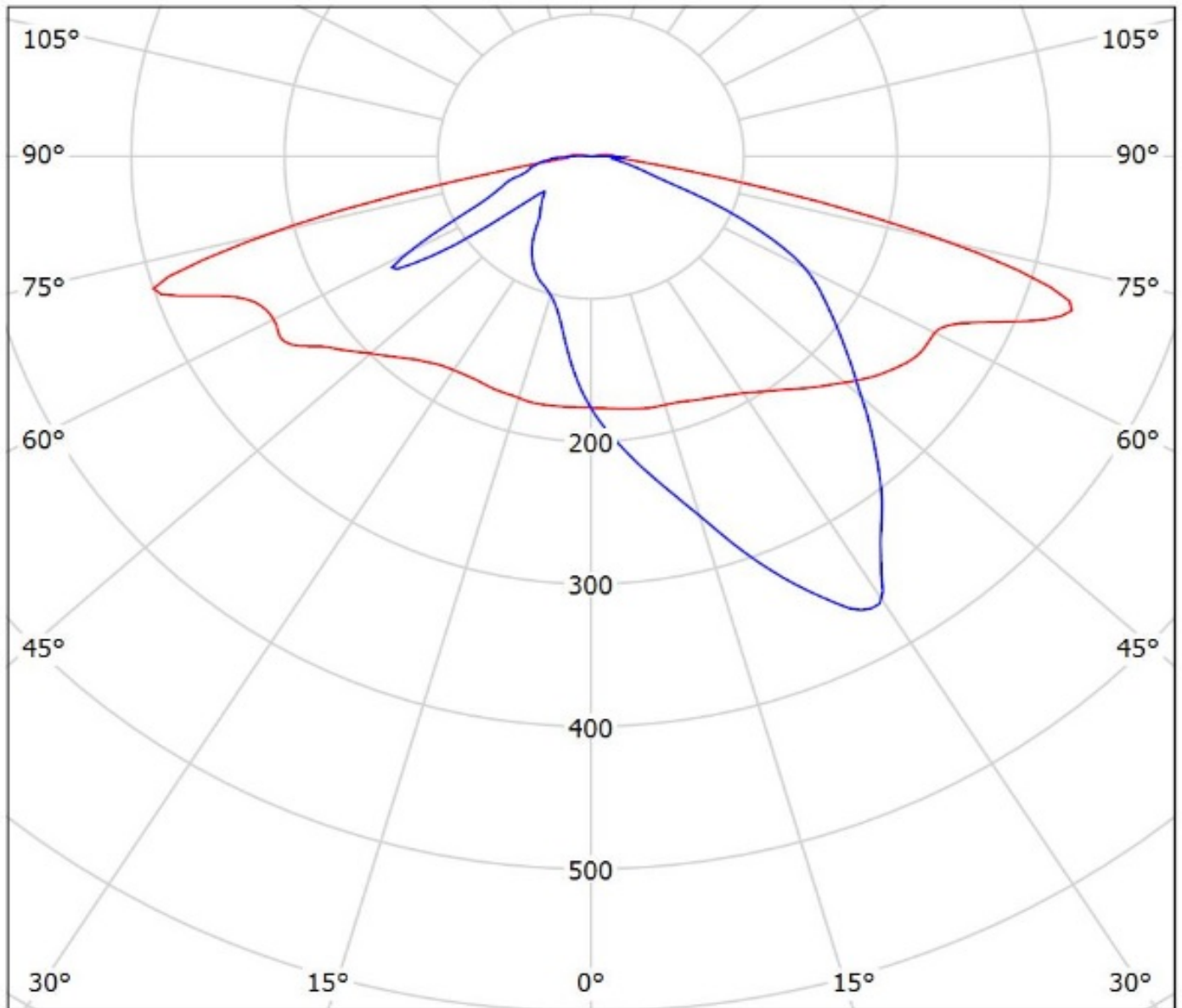

cd/klm

— C0 - C180

— C90 - C270

Luminaire: Ledil Oy C15035_STRADELLA-8-T3_(XP-G3)_SIMULATED
Lamps: 1 x Cree XP-G3

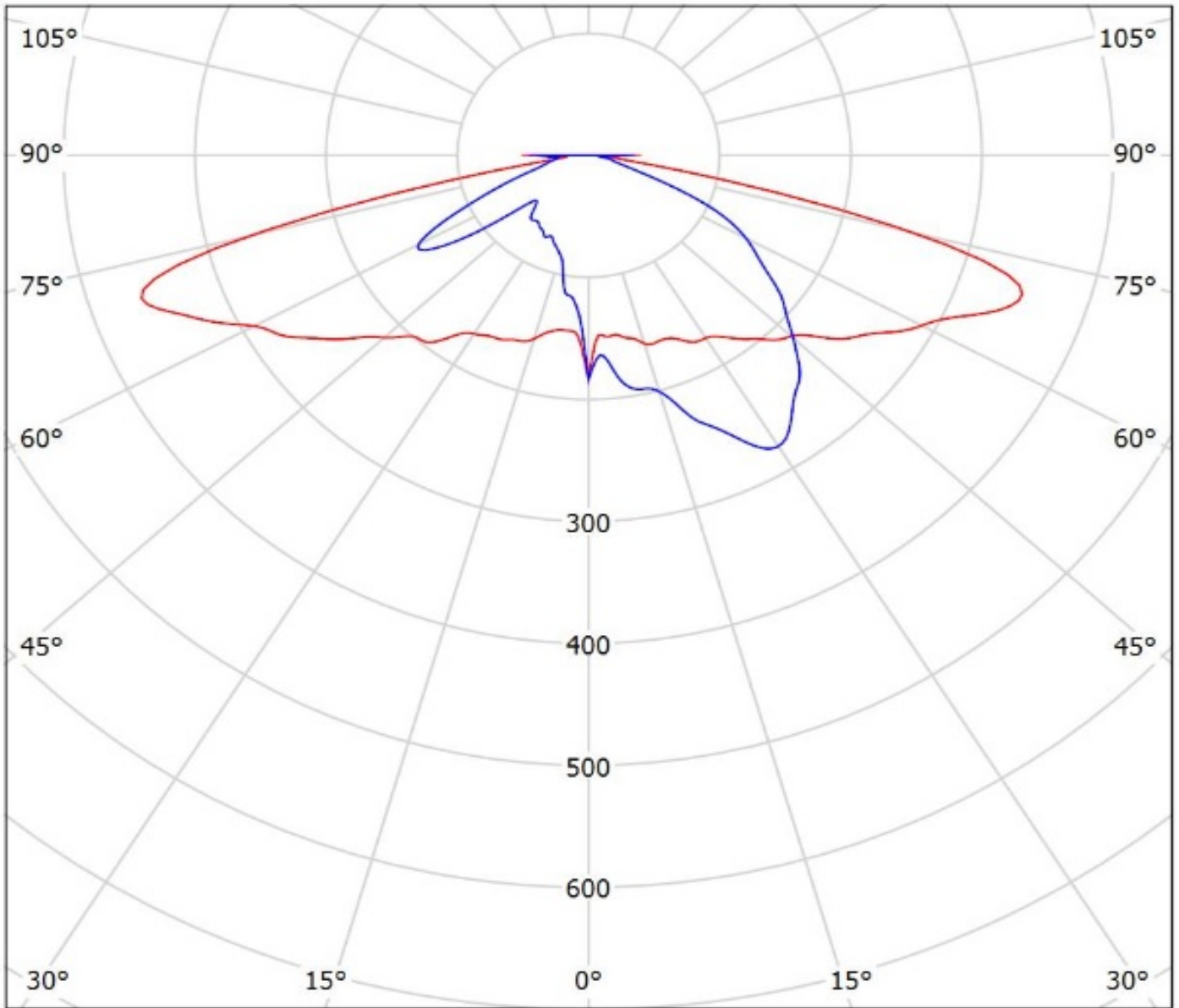

cd/klm
— C0 - C180 — C90 - C270

$\eta = 89\%$

Luminaire: LEDiL Oy C15035_STRADELLA-8-T3_(Luxeon_3030_2D)

Lamps: 1 x Luxeon_3030_2D_x8_(LI30-2780)_335.042lm@60mA_P=2.7141W_I=0.06A

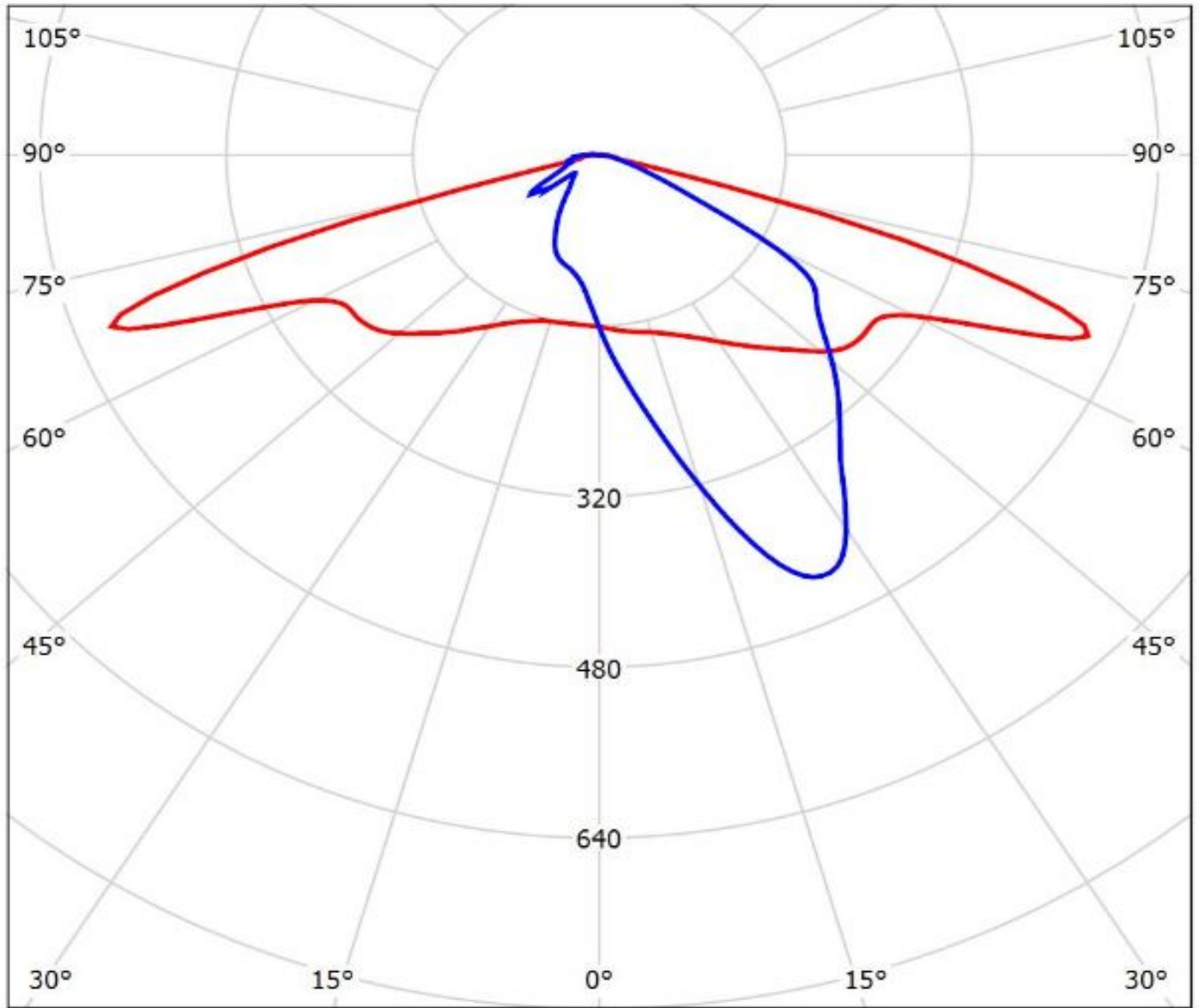

cd/klm

— C0 - C180 — C90 - C270

$\eta = 96\%$

Luminaire: LEDiL Oy C15035_STRADELLA-8-T3_(Luxeon_TX)
Lamps: 1 x Luxeon_TX_693.838lm@250mA_P=5.64523W_I=0.250A

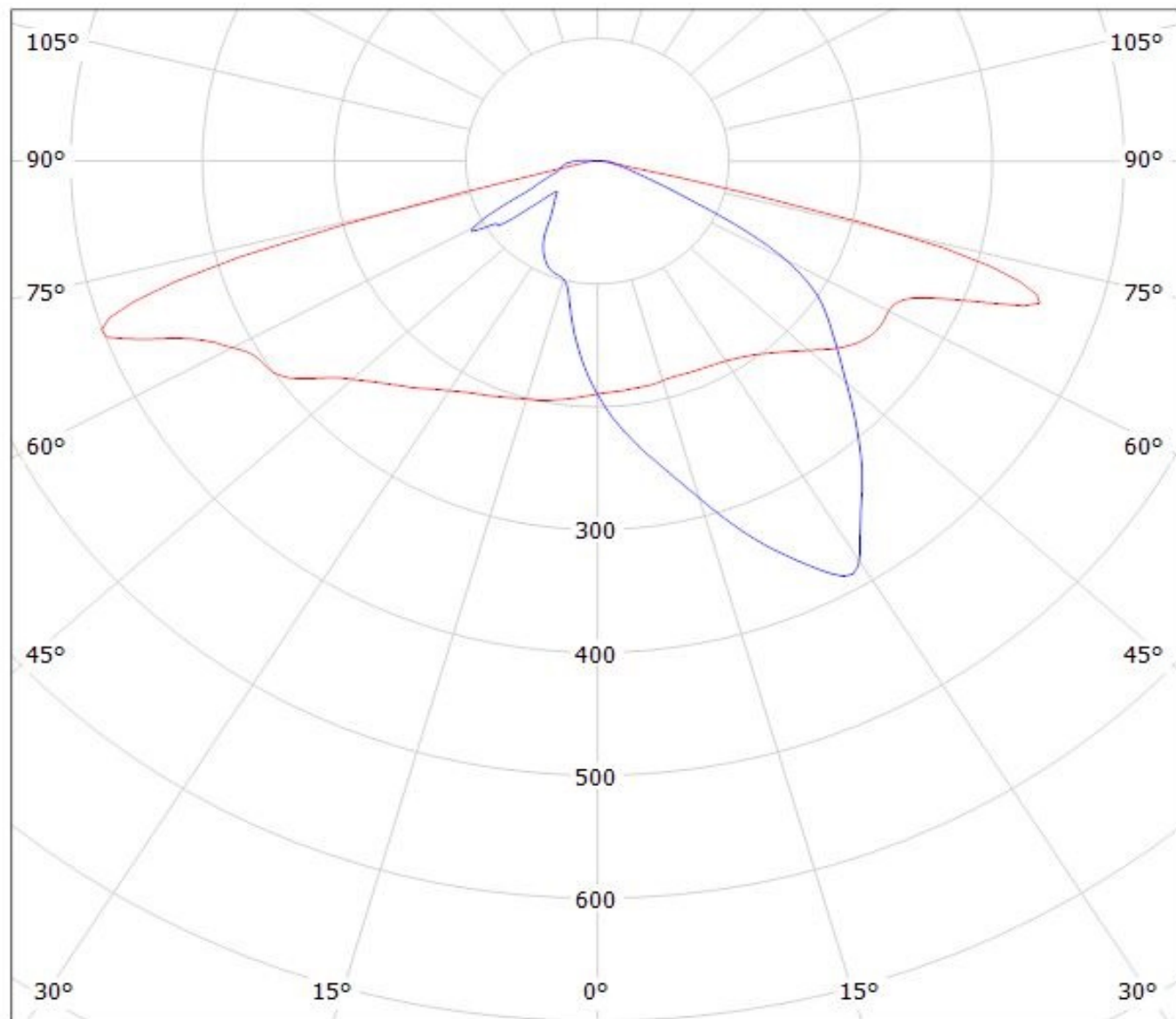

cd/klm

— C0 - C180 — C90 - C270

$\eta = 94\%$

Luminaire: Ledil Oy C15035_STRADELLA-8-T3_NICHIA_NVSW219C_SIMULATED
Lamps: 1 x NICHIA NVSW219C

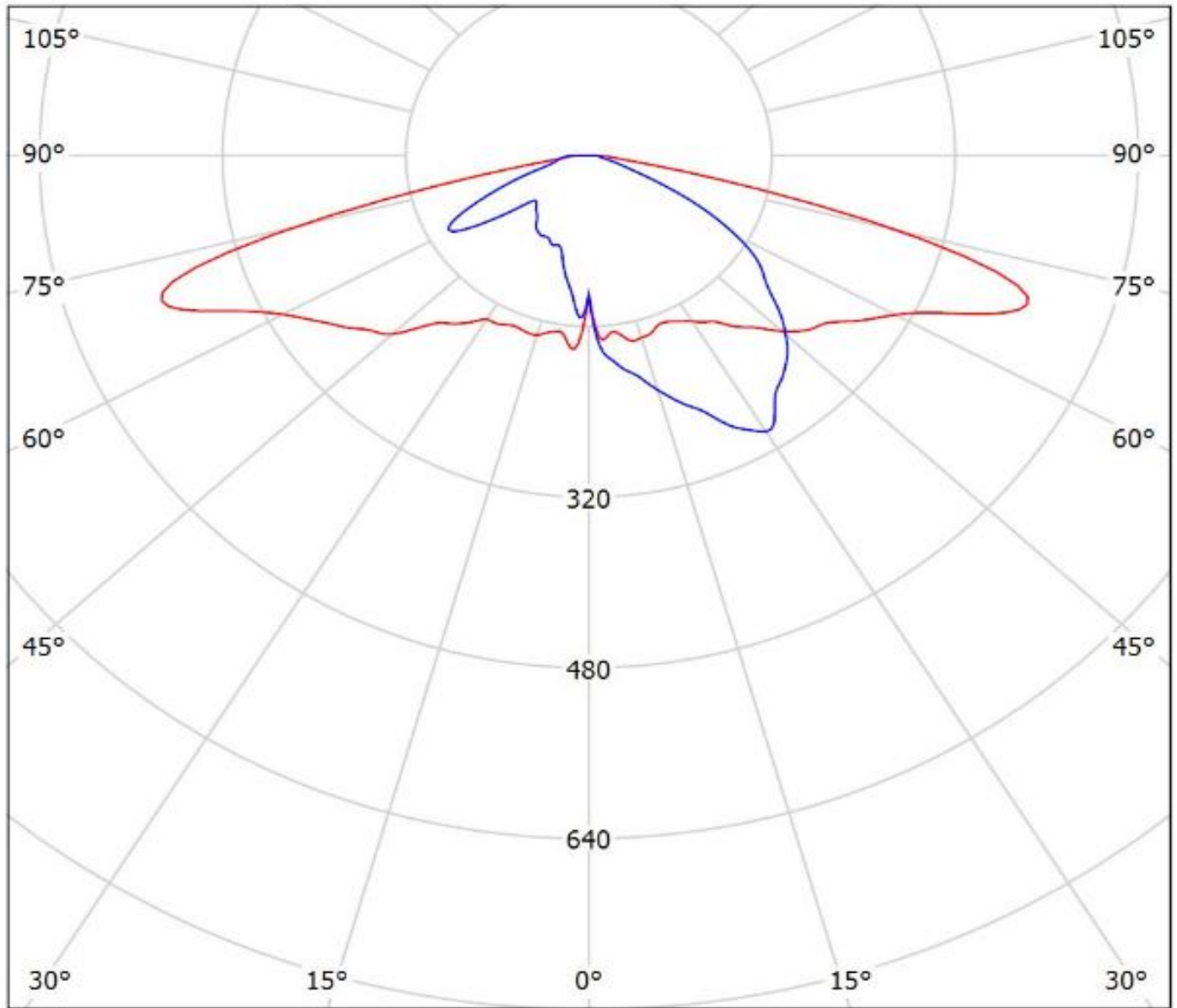

cd/klm

— C0 - C180 — C90 - C270

$\eta = 94\%$

Luminaire: Ledil Oy C15035_STRADELLA-8-T3_(NCSxE17A)_SIMULATED

Lamps: 1 x NCSWE17A

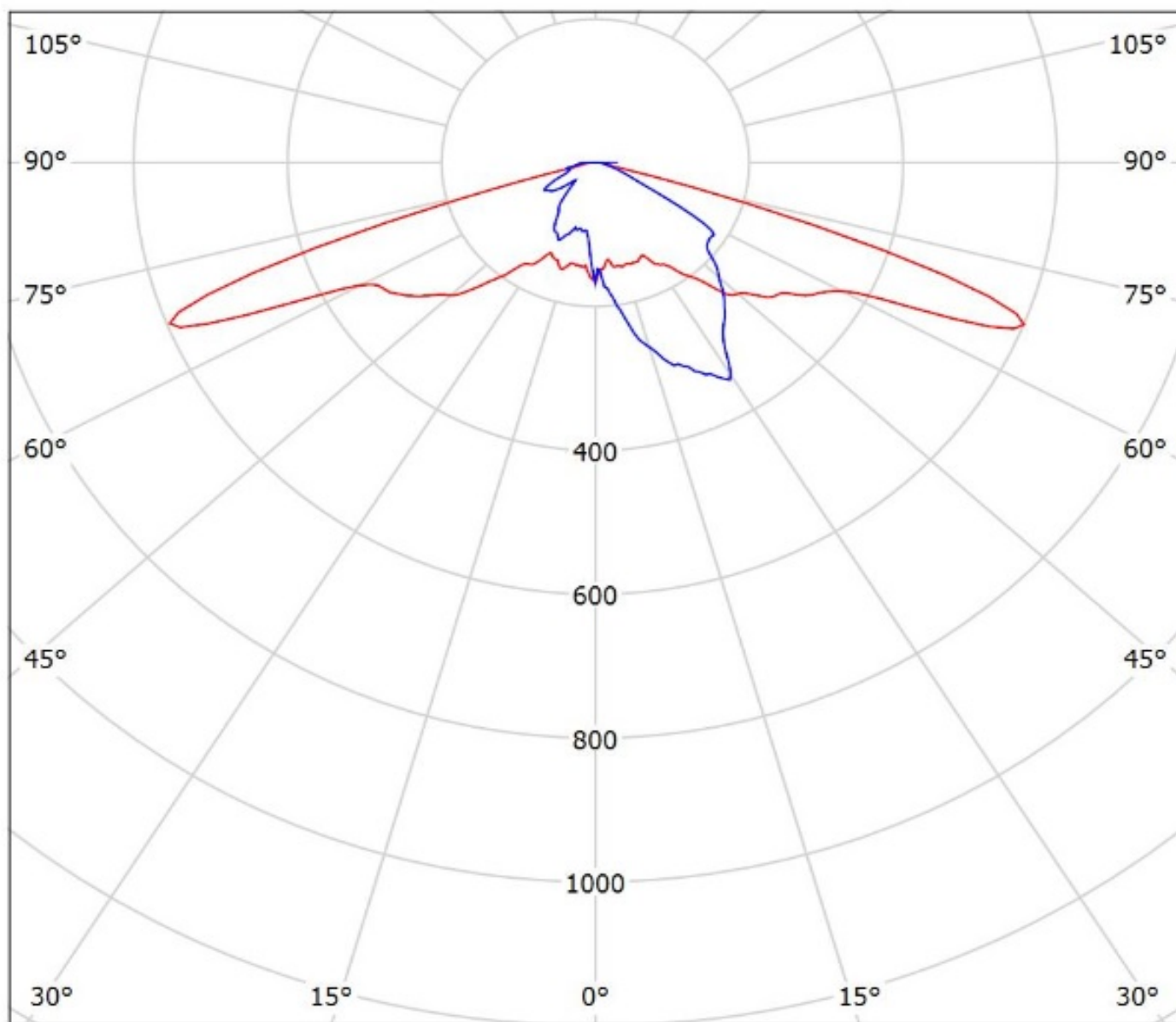

cd/klm

— C0 - C180 — C90 - C270

$\eta = 93\%$

Luminaire: Ledil Oy C15035_STRADELLA-8-T3_NVSE21AT_SIMULATED

Lamps: 1 x NICHIA NVSE21AT

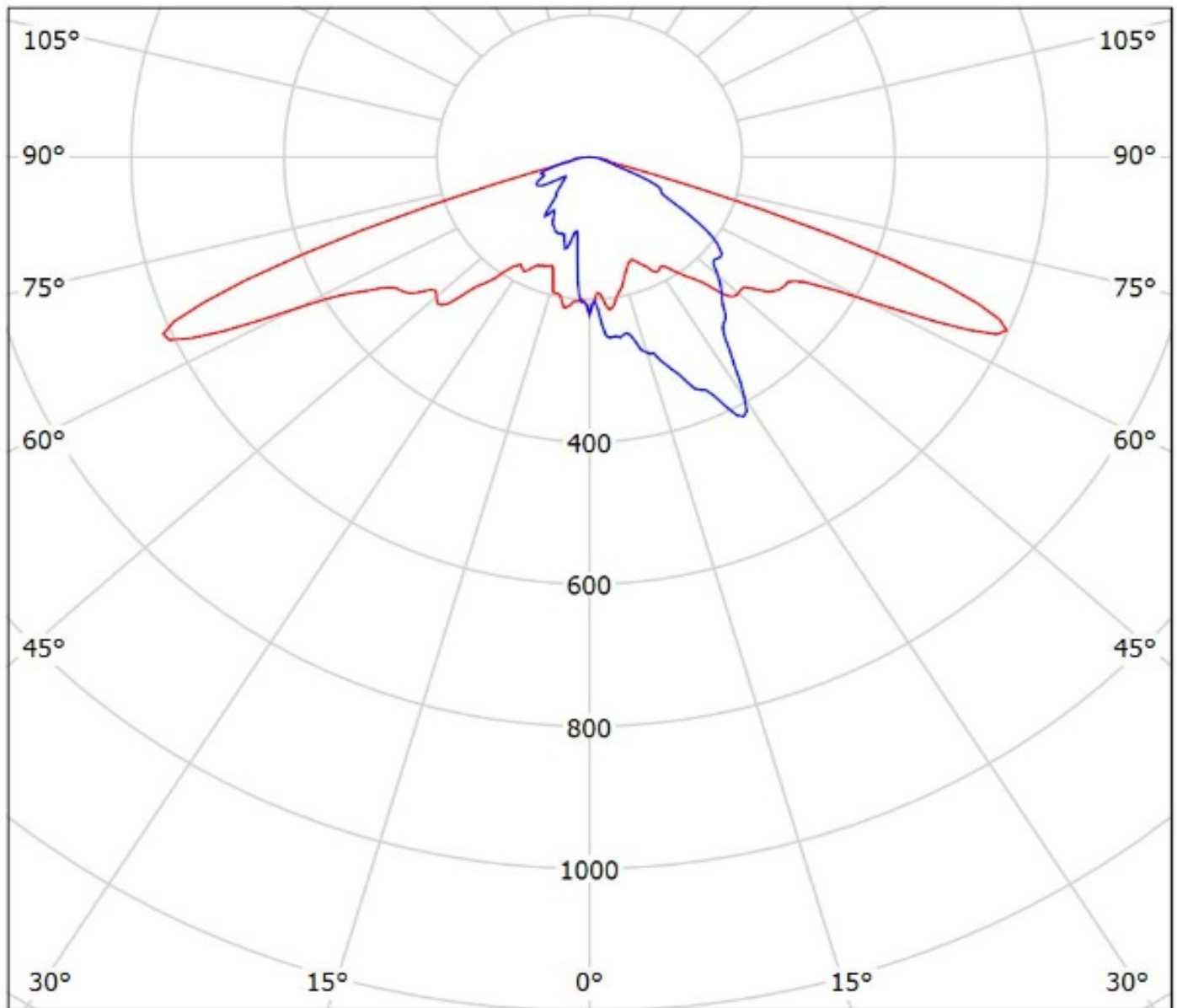

cd/klm

— C0 - C180 — C90 - C270

η = 99%

Luminaire: Ledil Oy C15035_STRADELLA-8-T3_SIMULATED
Lamps: 1 x Osram_OSCONIQ_P_3737_(2W_version)

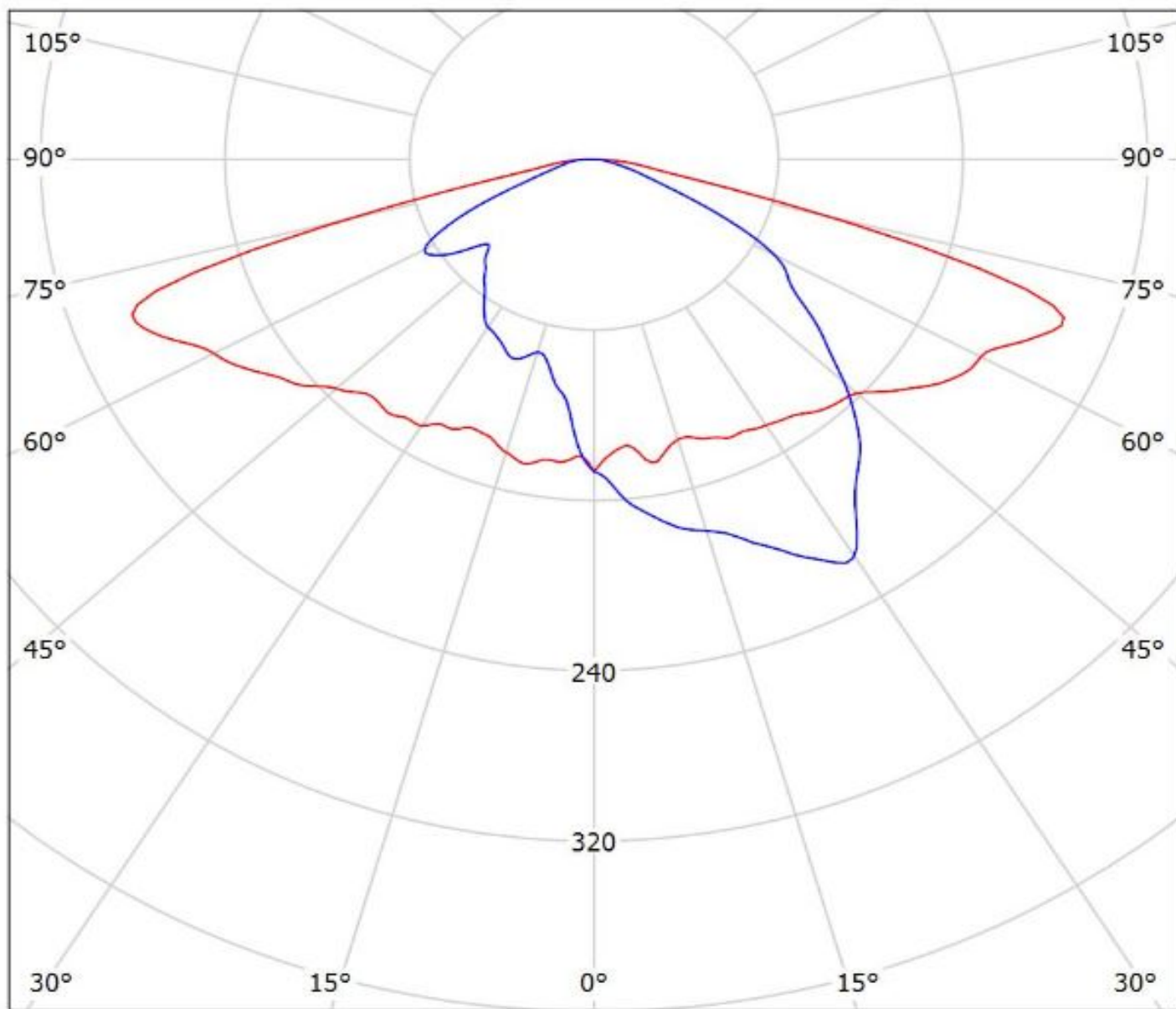

cd/klm

— C0 - C180 — C90 - C270

$\eta = 61\%$

Luminaire: Ledil Oy C15035_STRADELLA-8-T3_SIMULATED
Lamps: 1 x Osram_OSCONIQ_P_3737_(3W_version)

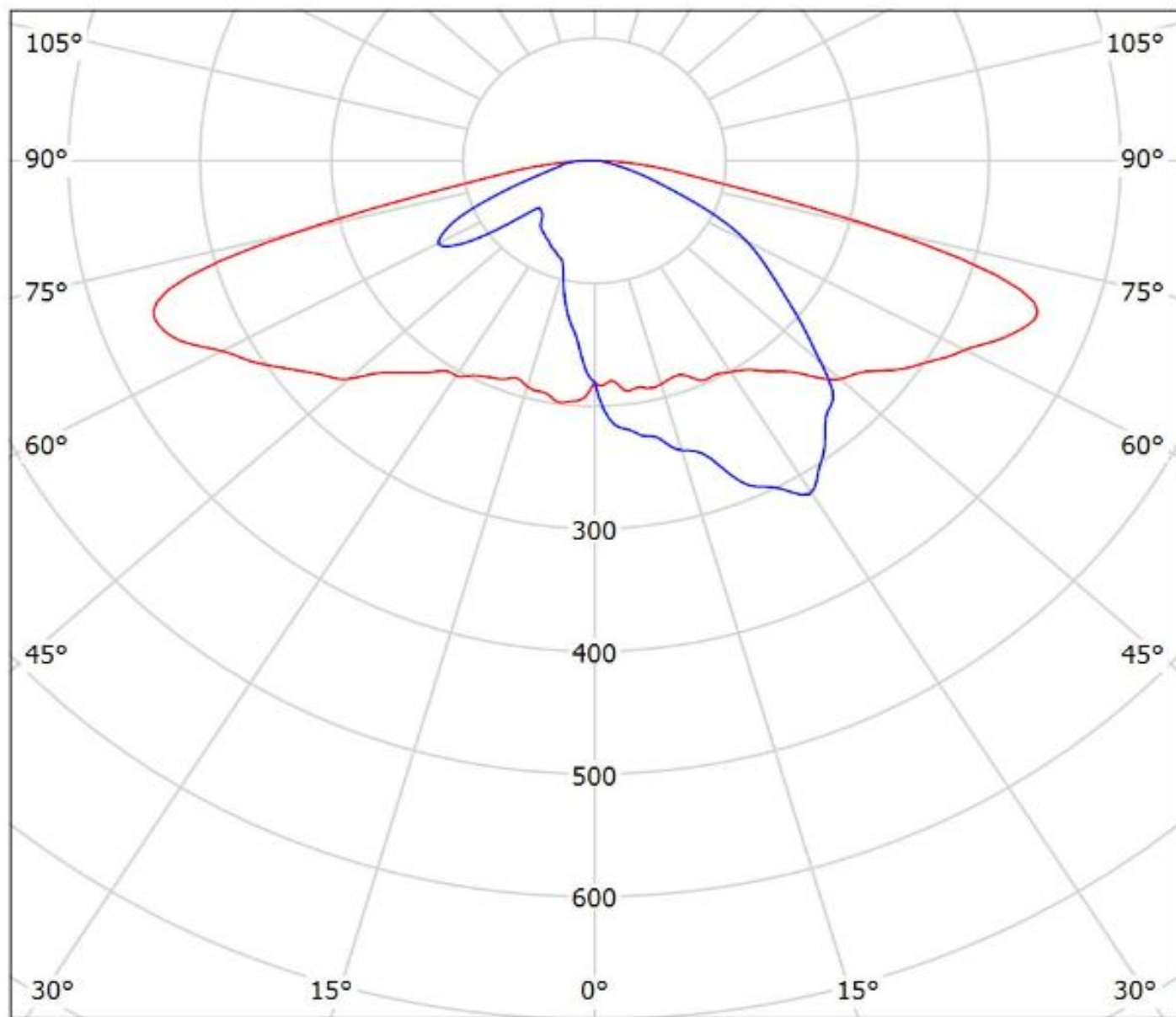

cd/klm
— C0 - C180 — C90 - C270

$\eta = 95\%$

Luminaire: Ledil Oy C15035_STRADELLA-8-T3_(Osram_Oslon Square PC)_(Glass)_SIMULATED
Lamps: 1 x Osram_Oslon Square PC

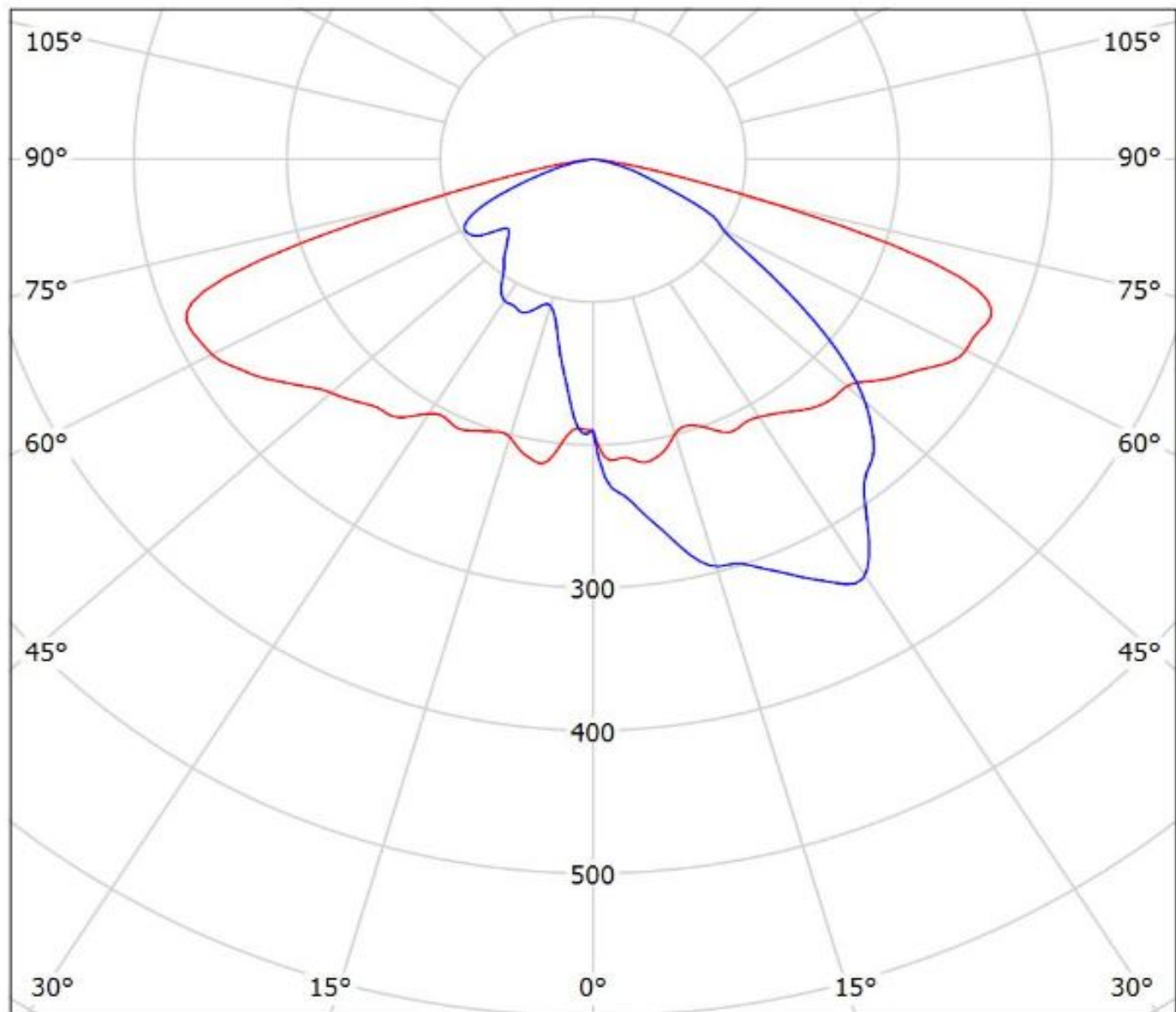

cd/klm

— C0 - C180 — C90 - C270

$\eta = 85\%$

Luminaire: Ledil Oy C15035_STRADELLA-8-T3_(LH351C)_SIMULATED
Lamps: 1 x Samsung LH351C

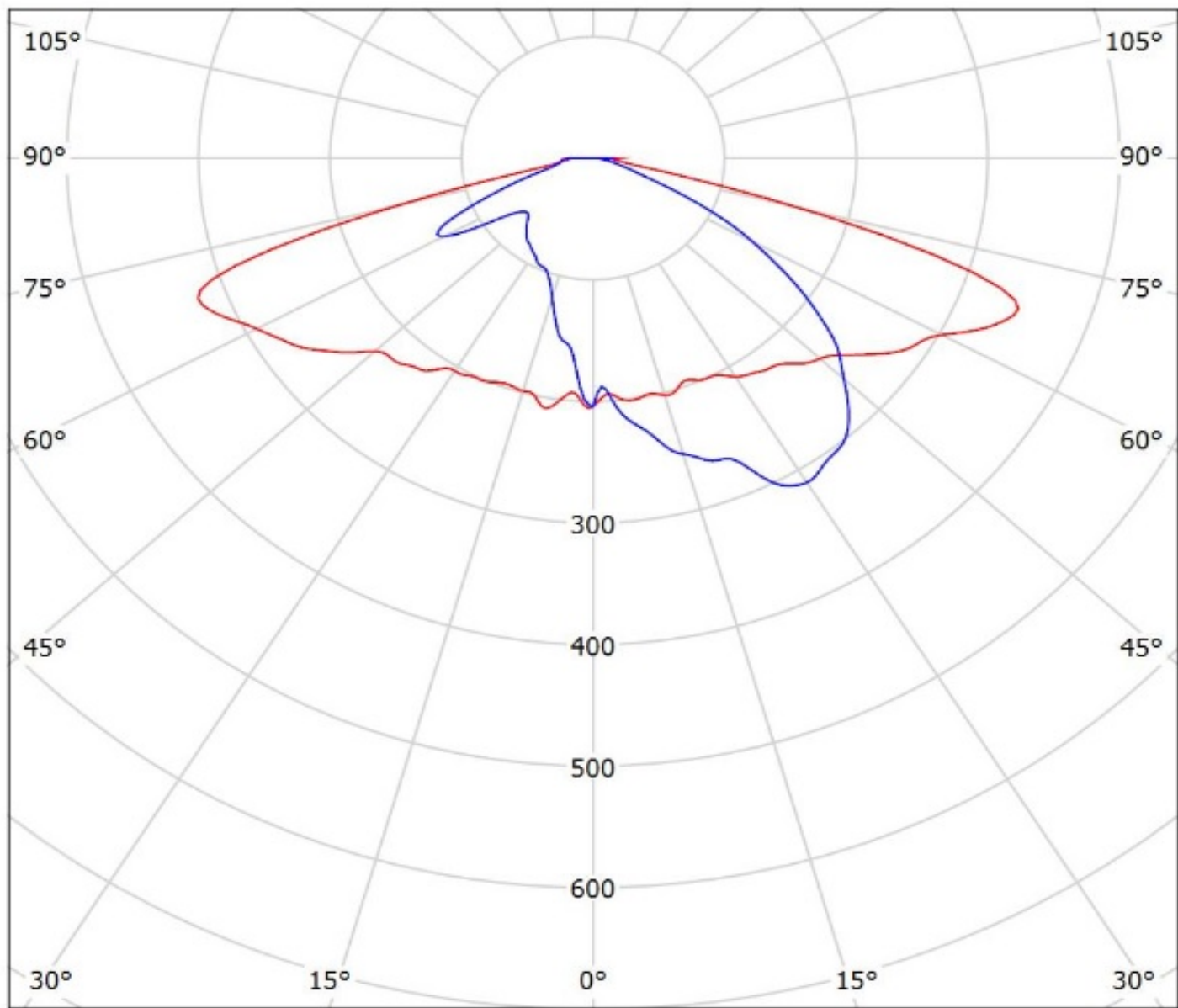

cd/klm

— C0 - C180 — C90 - C270

$\eta = 93\%$

Luminaire: LEDiL Oy C15035_STRADELLA-8-T3_(SZ8-Y19)

Lamps: 1 x Seoul_SZ8-Y19_(SZ8-Y19-W0-C7)_940.325lm@250mA_P=5.59177W_I=0.250A

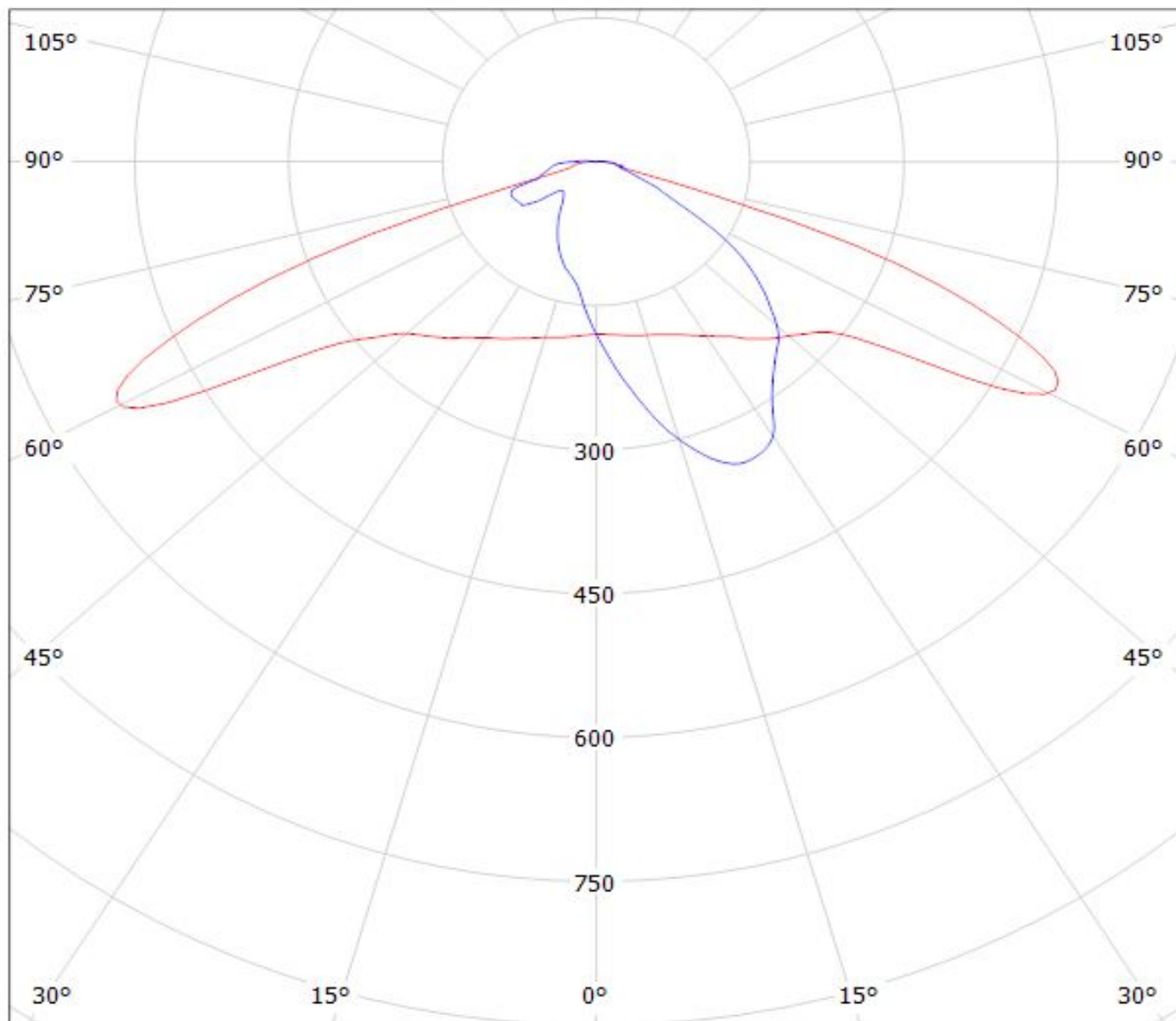

cd/klm

$\eta = 96\%$

— C0 - C180

— C90 - C270

Luminaire: LEDiL Oy C15035_STRADELLA-8-T3_(SZ8_Y22)

Lamps: 1 x Seoul_SZ8_Y22_(SZ8-Y22-W0-C7)_1002.11lm@250mA_P=5.42341W_I=0.250A

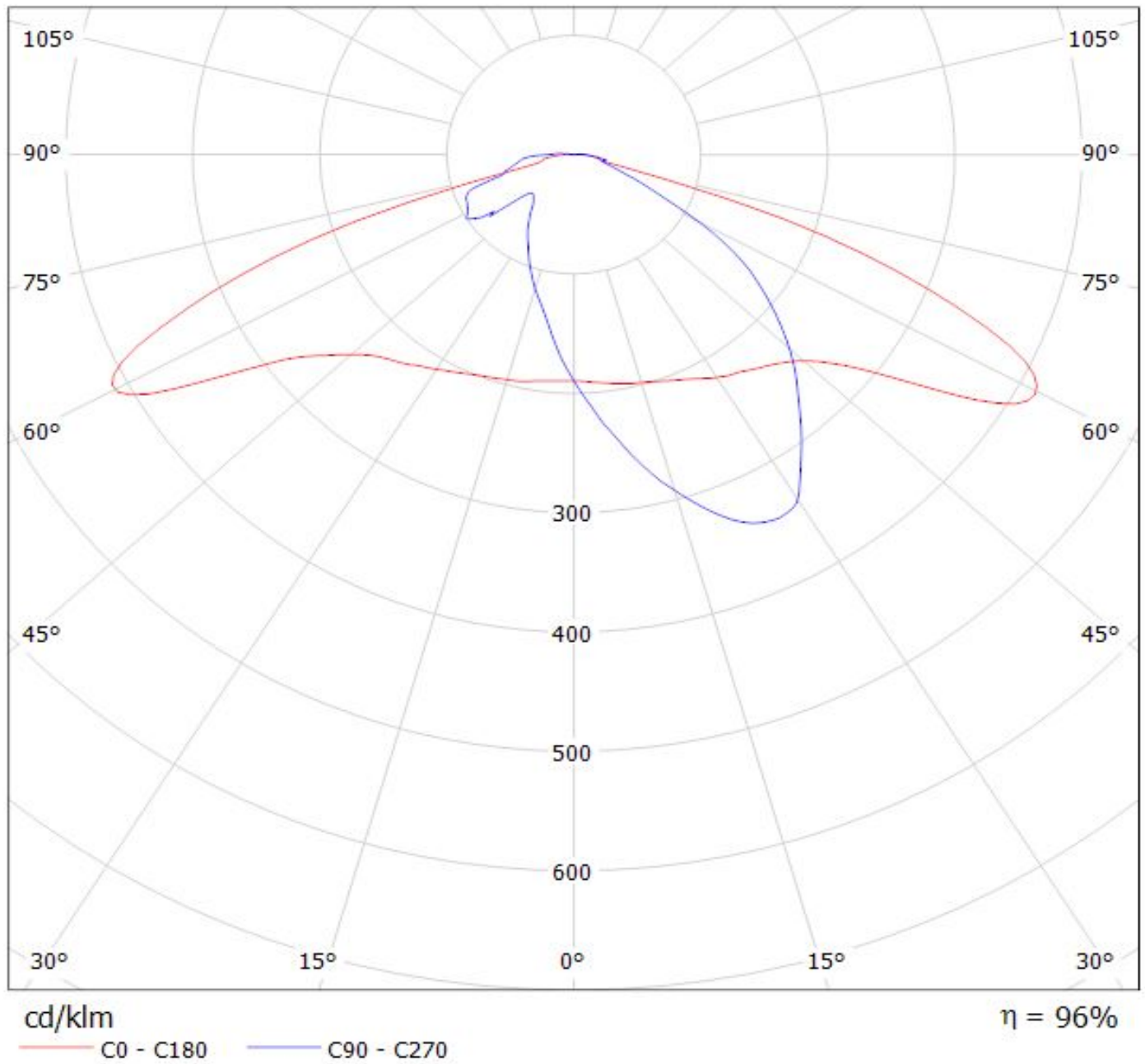

Luminaire: LEDiL Oy C15035_STRADELLA-8-T3_(Z8Y22P)

Lamps: 1 x Seoul_SZ8-Y22P_(SZ8-Y22-W0-C7-P)_957.081lm@250mA_P=5.49085W_I=0.25A

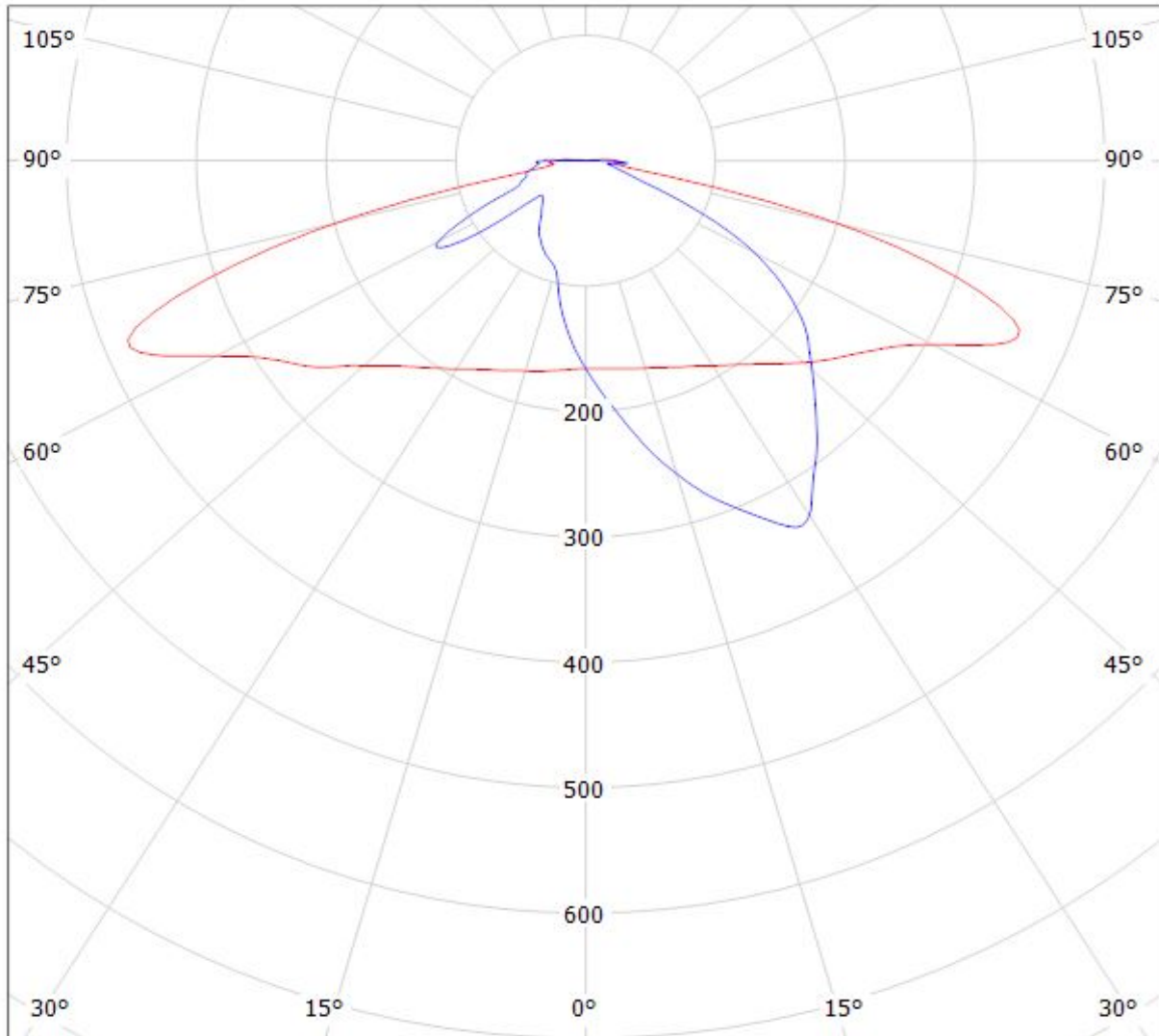

cd/klm

— C0 - C180

— C90 - C270

$\eta = 97\%$

NOTE: The typical divergence will be changed by different color, chip size and chip position tolerance. The typical total divergence is the full angle measured where the luminous intensity is half of the peak value.