

## PLCC Series

# 2835 0.5W LC

## Datasheet

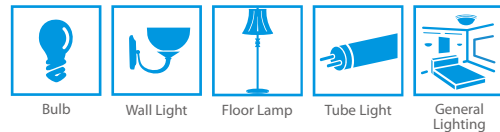

### Introduction :

Ultra high luminous efficacy, combined with the flexibility in design due to its slim and miniature size, PLCC LED Series are optimized to be used as lighting for building.

### Description :

- Best luminous and color uniformity
- Enables halogen and CDM replacement
- The article itself presents the actual color.

### Feature and Benefits :

- High luminous Intensity and high efficiency
- Based on InGaN / GaN technology
- Wide viewing angle : 120°
- Excellent performance and visibility
- Suitable for all SMT assembly methods
- IR reflow process compatible
- Environmental friendly; RoHS compliance

## Table of Contents

---

General Information .....	3
Absolute Maximum Ratings .....	4
Characteristics .....	4
Luminous Flux Characteristic.....	5
Voltage Bin Structure .....	5
Mechanical Dimensions.....	6
Color BIN code.....	7
Characteristic curve.....	12
Reflow Profile .....	17
Reliability.....	18
Product Packaging Information.....	19
Revision History .....	20
About Edison Opto .....	20

## General Information

### Ordering Code Format

$\frac{2}{X1}$       $\frac{T}{X2}$       $\frac{03}{X3-X4}$       $\frac{X5}{X5-X6}$       $\frac{xW}{X7-X8}$       $\frac{xx}{X9-X10}$       $\frac{000}{X11-X13}$       $\frac{xxx}{X14-X16}$

X1		X2		X3-X4		X5-X6		X7-X8	
Type		Component		Series		Wattage		Color	
2	Emitter	T	PLCC	03	3528	X5	0.5W	CW	Cool White
								NW	Neutral White
								WW	Warm White

X9-X10		X11-X13		X14-X16	
Internal code		PCB Board		Serial Number	
-	-	000	-	-	-

## Absolute Maximum Ratings

Absolute maximum ratings ( $T_a=25^{\circ}\text{C}$ )

Parameter	Symbol	Value	Units
Forward Current	$I_F$	200	mA
Pulse Forward Current ( $t_p \leq 100\mu\text{s}$ , Duty cycle=0.25)	$I_{\text{pulse}}$	400	mA
Reverse Current	$I_R$	10	$\mu\text{A}$
Reverse Voltage	$V_R$	5	V
LED Junction Temperature	$T_J$	125	$^{\circ}\text{C}$
Operating Temperature	-	-40 ~ +85	$^{\circ}\text{C}$
Storage Temperature	-	-40 ~ +125	$^{\circ}\text{C}$
ESD Sensitivity (HBM)	$V_B$	2,000	V
Soldering Temperature	$T_s$	Reflow Soldering : 255~260 $^{\circ}\text{C}$ /10~30sec Manual Soldering : 350 $^{\circ}\text{C}$ /3sec	

Notes:

1. Proper current derating must be observed to maintain junction temperature below the maximum at all time.
2. LEDs are not designed to be driven in reverse bias.

## Characteristics

Parameter	Symbol	Value	Units
Viewing Angle	(Typ.) $2\theta_{1/2}$	120	Degree
Thermal resistance	-	20	$^{\circ}\text{C}/\text{W}$
CRI (Ra) (85 $^{\circ}\text{C}$ )	-	>80	-
CCT (Cool White) (Neutral White) (Warm White)	-	2,700	K
		3,000	
		3,500	
		4,000	
		5,000	
		5,700 6,500	
JEDEC Moisture Sensitivity	-	Level 2a <b>Floor Life</b> Conditions: $\leq 30^{\circ}\text{C}$ / 60% RH <b>Soak Requirements(Standard)</b> Time (hours): 120+1/-0 Conditions: 60 $^{\circ}\text{C}$ / 60% RH	

Notes:

1.  $2\theta_{1/2}$  is the off-axis angle where the luminous intensity is half of the axial luminous intensity.
2. Color Rendering index CRI tolerance:  $\pm 2$ .
3. CIE\_x/y tolerance:  $\pm 0.005$ .

## Luminous Flux Characteristic

Luminous Flux Characteristics,  $I_f=150\text{mA}$  and  $T_j=25^\circ\text{C}$

Color	Group	Min. Luminous Flux(lm)	Max. Luminous Flux(lm)	Forward Current (mA)	Order Code		
Cool White	55	55	60	150	2T03X5CW99000001		
	60	60	65				
	65	65	70				
Neutral White	55	55	60		150	2T03X5NW99000001	
	60	60	65				
	65	65	70				
Warm White	50	50	55			150	2T03X5WW99000001
	55	55	60				
	60	60	65				

Note:

The luminous flux performance is guaranteed within published operating conditions. Edison Opto maintains a tolerance of  $\pm 10\%$  on flux measurements.

## Voltage Bin Structure

Group	Min. Voltage (V)	Max. Voltage (V)
VB1	2.9	3.0
VC1	3.0	3.1
VA2	3.1	3.2
VB2	3.2	3.3
VC2	3.3	3.4
VA3	3.4	3.5
VB3	3.5	3.6

Note:

Forward voltage measurement allowance is  $\pm 0.06\text{V}$ .

## Mechanical Dimensions

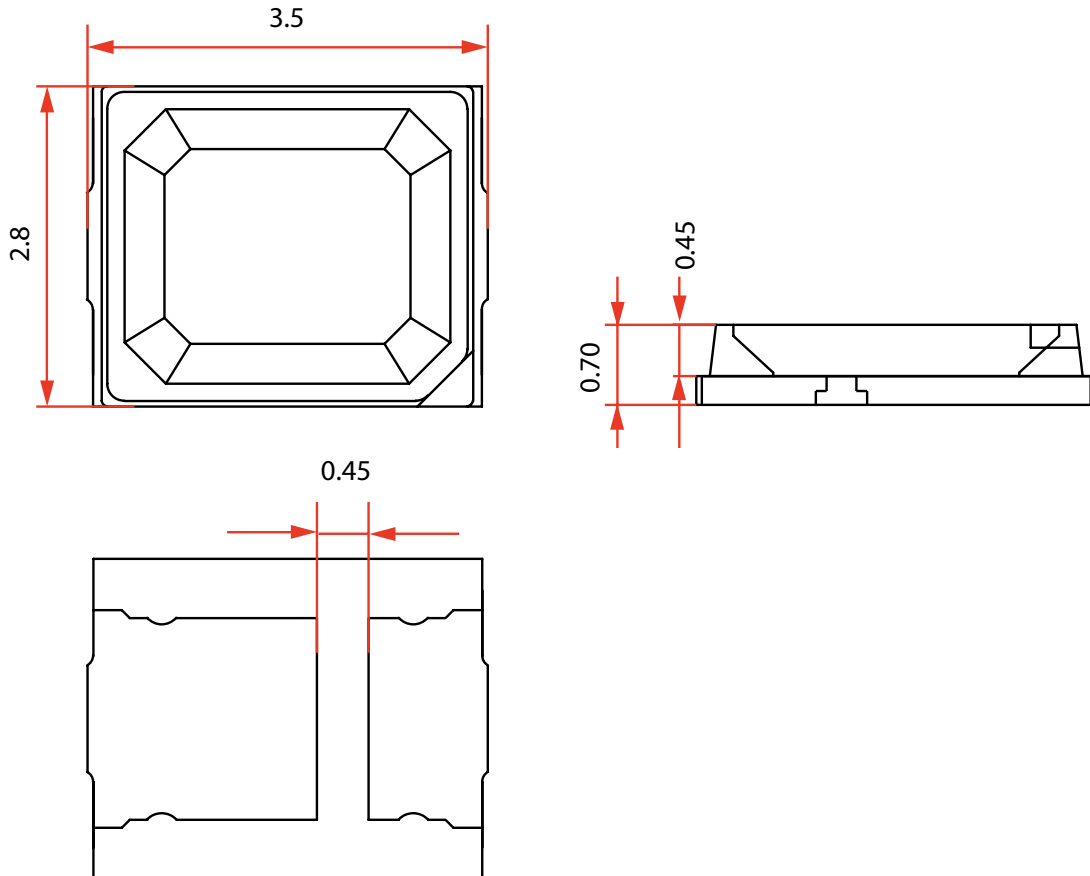

### Circuit

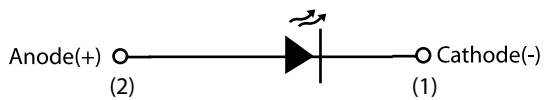

### Solder Pad

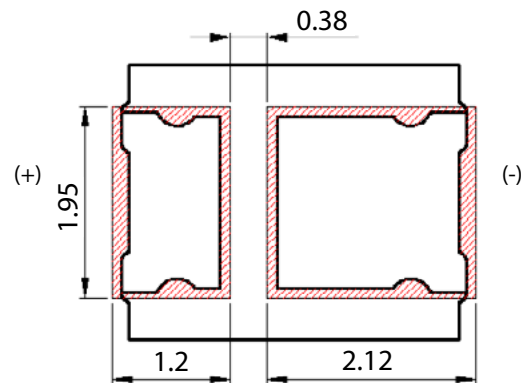

#### Notes:

1. All dimensions are measured in mm.
2. Tolerance :  $\pm 0.2$  mm

## Color BIN code

Color region stay within Macadam "3-Step/5-step" ellipse from the chromaticity center.  
The chromaticity center refers to ANSI C78.377:2008.  
Please refer to ANSI C78.377 for the chromaticity center.

CCT	Steps	Cx	Cy	a	b	theta
2700K	5	0.4578	0.4101	0.01350	0.00700	53.70
3000K	5	0.4338	0.4030	0.01390	0.00680	53.22
3500K	5	0.4073	0.3917	0.01545	0.00690	54.00
4000K	5	0.3818	0.3797	0.01565	0.00670	53.72
5000K	5	0.3447	0.3553	0.01370	0.00590	59.62
5700K	5	0.3287	0.3417	0.01243	0.00533	59.09
6500K	5	0.3123	0.3282	0.01115	0.00475	58.57

CCT	Steps	Cx	Cy	a	b	theta
2700K	3	0.4578	0.4101	0.00810	0.00420	53.70
3000K	3	0.4338	0.4030	0.00834	0.00408	53.22
3500K	3	0.4073	0.3917	0.00927	0.00414	54.00
4000K	3	0.3818	0.3797	0.00939	0.00402	53.72
5000K	3	0.3447	0.3553	0.00822	0.00354	59.62
5700K	3	0.3287	0.3417	0.00746	0.00320	59.09
6500K	3	0.3123	0.3282	0.00669	0.00285	58.57

## Cool White

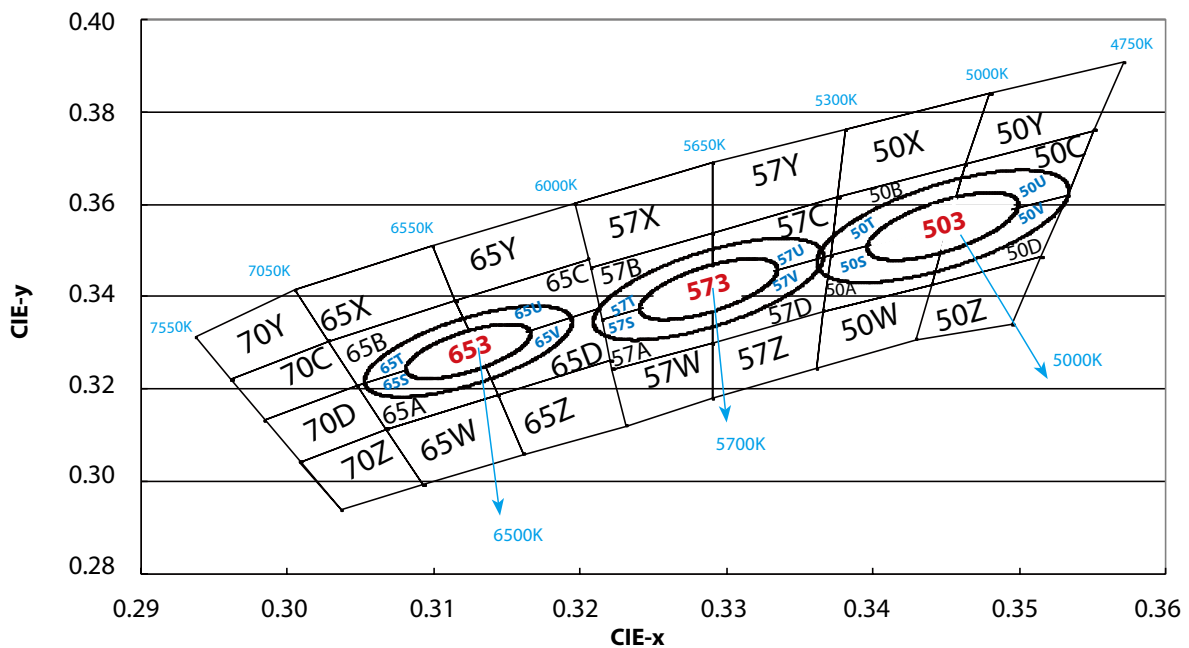

### Cool White 65H

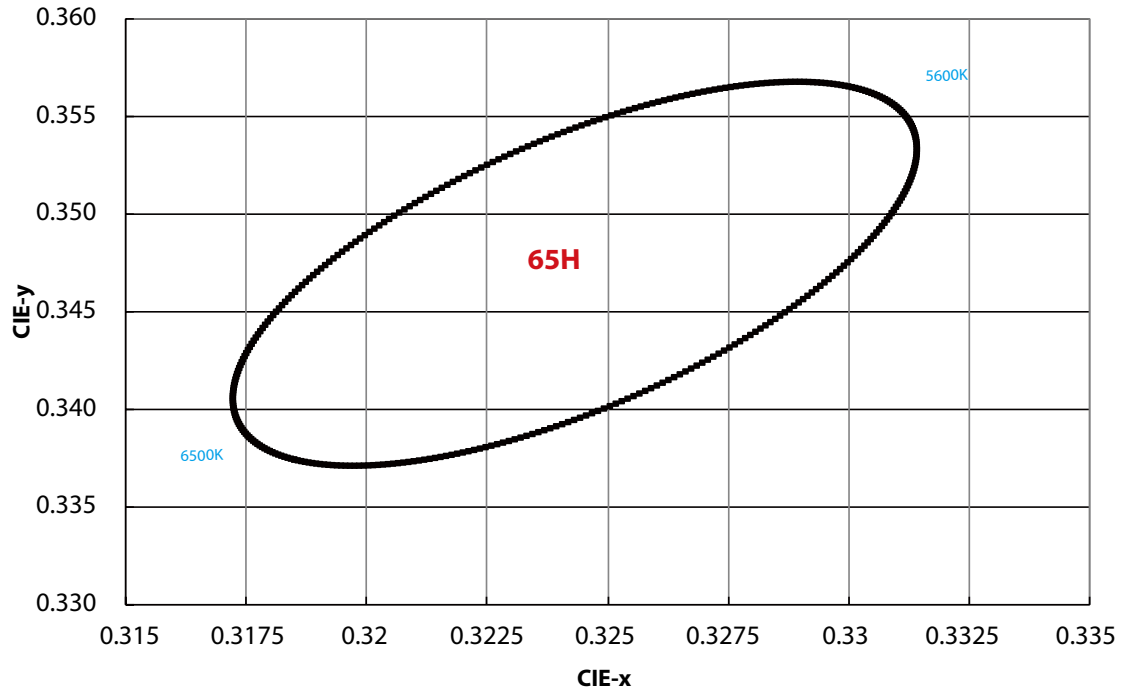

CCT	Steps	Cx	Cy	a	b	theta
65H	5	0.3209	0.3427	0.01338	0.0057	58.57

### Neutral White

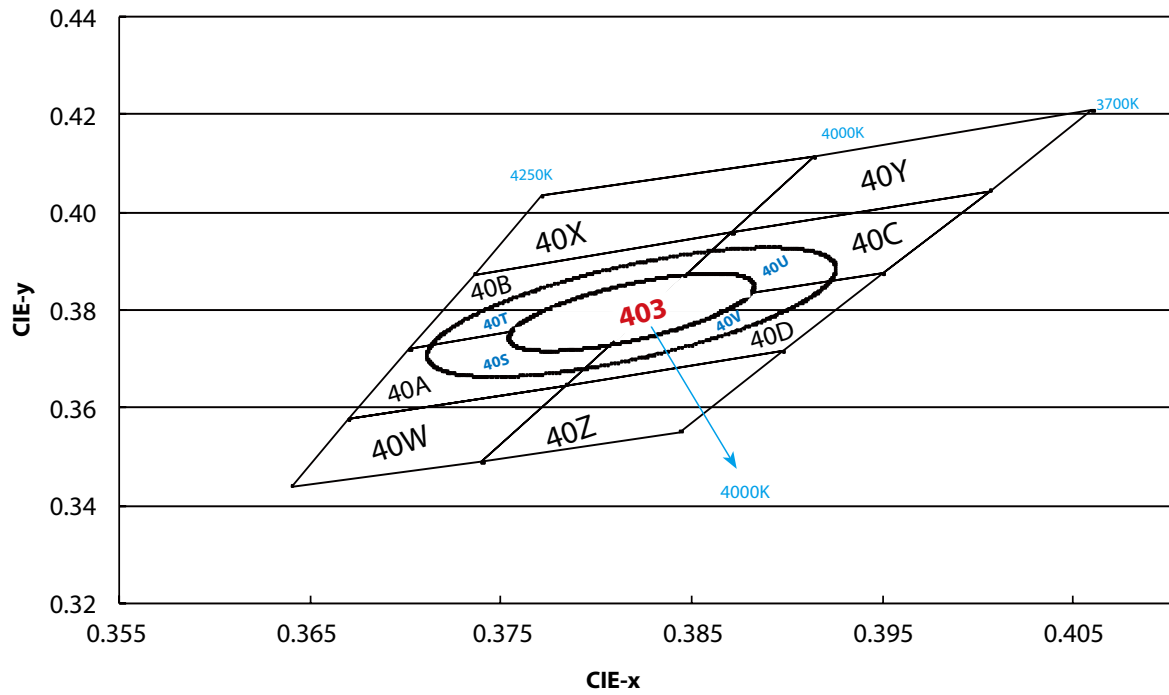

### Warm White

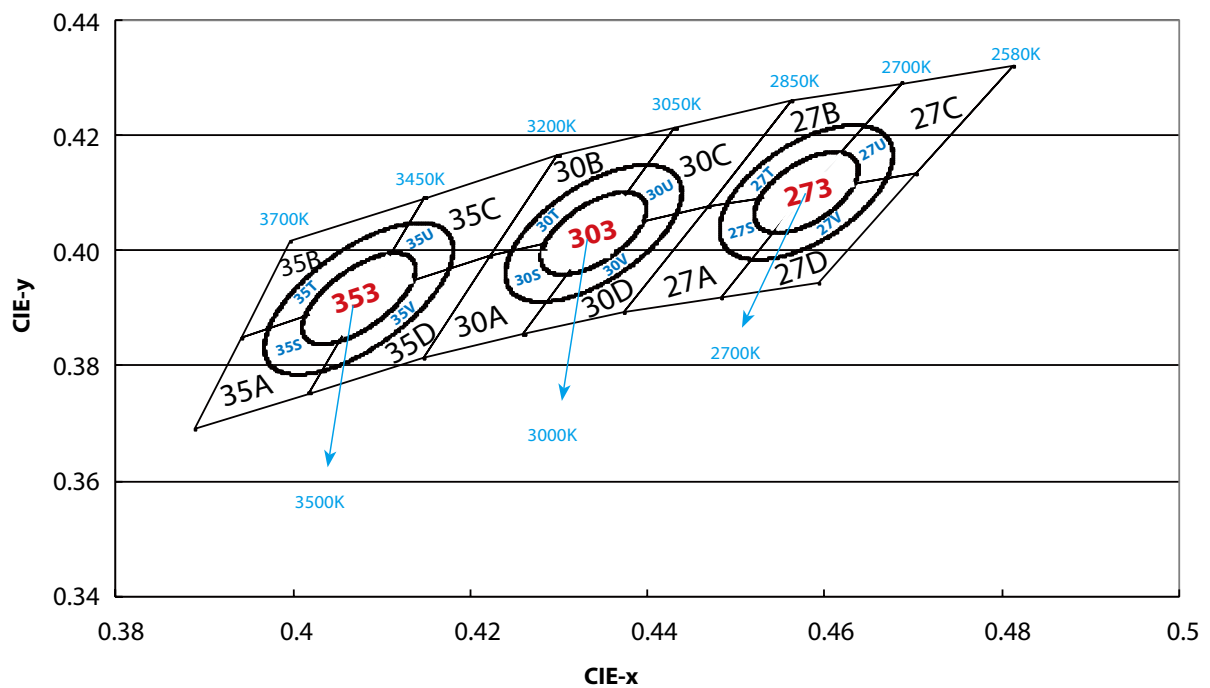

### 6500K

65X		65B		65A		65W	
X	Y	X	Y	X	Y	X	Y
0.3005	0.3415	0.3115	0.3391	0.3130	0.3290	0.3068	0.3113
0.3099	0.3509	0.3028	0.3304	0.3048	0.3207	0.3144	0.3186
0.3115	0.3391	0.3048	0.3207	0.3068	0.3113	0.3161	0.3059
0.3028	0.3304	0.3130	0.3290	0.3144	0.3186	0.3093	0.2993

65Y		65C		65D		65Z	
X	Y	X	Y	X	Y	X	Y
0.3099	0.3509	0.3205	0.3481	0.3213	0.3373	0.3144	0.3186
0.3196	0.3602	0.3115	0.3391	0.3130	0.3290	0.3221	0.3261
0.3205	0.3481	0.3130	0.3290	0.3144	0.3186	0.3231	0.3120
0.3115	0.3391	0.3213	0.3373	0.3221	0.3261	0.3161	0.3059

### 5700K

57X		57B		57A		57W	
X	Y	X	Y	X	Y	X	Y
0.3196	0.3602	0.3290	0.3538	0.3290	0.3417	0.3222	0.3243
0.3290	0.3690	0.3207	0.3462	0.3215	0.3350	0.3290	0.3300
0.3290	0.3538	0.3215	0.3350	0.3222	0.3243	0.3290	0.3180
0.3207	0.3462	0.3290	0.3417	0.3290	0.3300	0.3231	0.3120

57Y		57C		57D		57Z	
X	Y	X	Y	X	Y	X	Y
0.3290	0.3690	0.3376	0.3616	0.3371	0.3490	0.3290	0.3300
0.3381	0.3762	0.3290	0.3538	0.3290	0.3417	0.3366	0.3369
0.3376	0.3616	0.3290	0.3417	0.3290	0.3300	0.3361	0.3245
0.3290	0.3538	0.3371	0.3490	0.3366	0.3369	0.3290	0.3180

### 5000K

50X		50B		50A		50W	
X	Y	X	Y	X	Y	X	Y
0.3381	0.3762	0.3463	0.3687	0.3451	0.3554	0.3366	0.3369
0.3480	0.3840	0.3376	0.3616	0.3371	0.3490	0.3440	0.3427
0.3463	0.3687	0.3371	0.3490	0.3366	0.3369	0.3429	0.3307
0.3376	0.3616	0.3451	0.3554	0.3440	0.3427	0.3361	0.3245

50Y		50C		50D		50Z	
X	Y	X	Y	X	Y	X	Y
0.3480	0.3840	0.3551	0.3760	0.3533	0.3620	0.3440	0.3427
0.3571	0.3907	0.3463	0.3687	0.3451	0.3554	0.3515	0.3487
0.3551	0.3760	0.3451	0.3554	0.3440	0.3427	0.3495	0.3339
0.3463	0.3687	0.3533	0.3620	0.3515	0.3487	0.3429	0.3307

### 4000K

40X		40B		40A		40W	
X	Y	X	Y	X	Y	X	Y
0.3771	0.4034	0.3871	0.3959	0.3828	0.3803	0.3670	0.3578
0.3736	0.3874	0.3736	0.3874	0.3702	0.3722	0.3640	0.3440
0.3871	0.3959	0.3702	0.3722	0.3670	0.3578	0.3740	0.3491
0.3914	0.4115	0.3828	0.3803	0.3784	0.3647	0.3784	0.3647

40Y		40C		40D		40Z	
X	Y	X	Y	X	Y	X	Y
0.3914	0.4115	0.4006	0.4044	0.3950	0.3875	0.3784	0.3647
0.3871	0.3959	0.3871	0.3959	0.3828	0.3803	0.3740	0.3491
0.4006	0.4044	0.3828	0.3803	0.3784	0.3647	0.3844	0.3552
0.4060	0.4208	0.3950	0.3875	0.3898	0.3716	0.3898	0.3716

### 3500K

35A		35B		35C		35D	
X	Y	X	Y	X	Y	X	Y
0.4083	0.3921	0.4148	0.4090	0.4299	0.4165	0.4223	0.399
0.3941	0.3848	0.3996	0.4015	0.4148	0.4090	0.4083	0.3921
0.3889	0.3690	0.3941	0.3848	0.4083	0.3921	0.4018	0.3752
0.4018	0.3752	0.4083	0.3921	0.4223	0.399	0.4147	0.3814

### 3000K

30A		30B		30C		30D	
X	Y	X	Y	X	Y	X	Y
0.4345	0.4033	0.4431	0.4213	0.4562	0.4260	0.4468	0.4077
0.4223	0.3990	0.4299	0.4165	0.4431	0.4213	0.4345	0.4033
0.4147	0.3814	0.4223	0.3990	0.4345	0.4033	0.4260	0.3854
0.4260	0.3854	0.4345	0.4033	0.4468	0.4077	0.4373	0.3893

### 2700K

27A		27B		27C		27D	
X	Y	X	Y	X	Y	X	Y
0.4578	0.4101	0.4687	0.4289	0.4813	0.4319	0.4703	0.4132
0.4468	0.4077	0.4562	0.4260	0.4687	0.4289	0.4578	0.4101
0.4373	0.3893	0.4468	0.4077	0.4578	0.4101	0.4483	0.3919
0.4483	0.3919	0.4578	0.4101	0.4703	0.4132	0.4593	0.3944

## Characteristic curve

### Color Spectrum

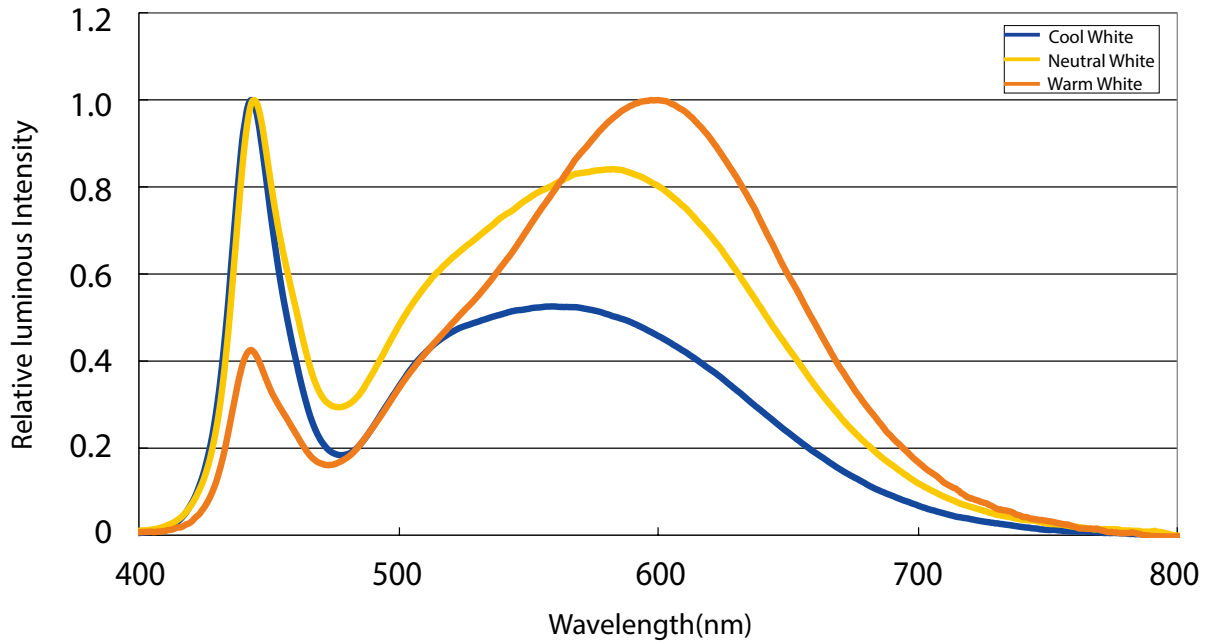

### Beam Pattern

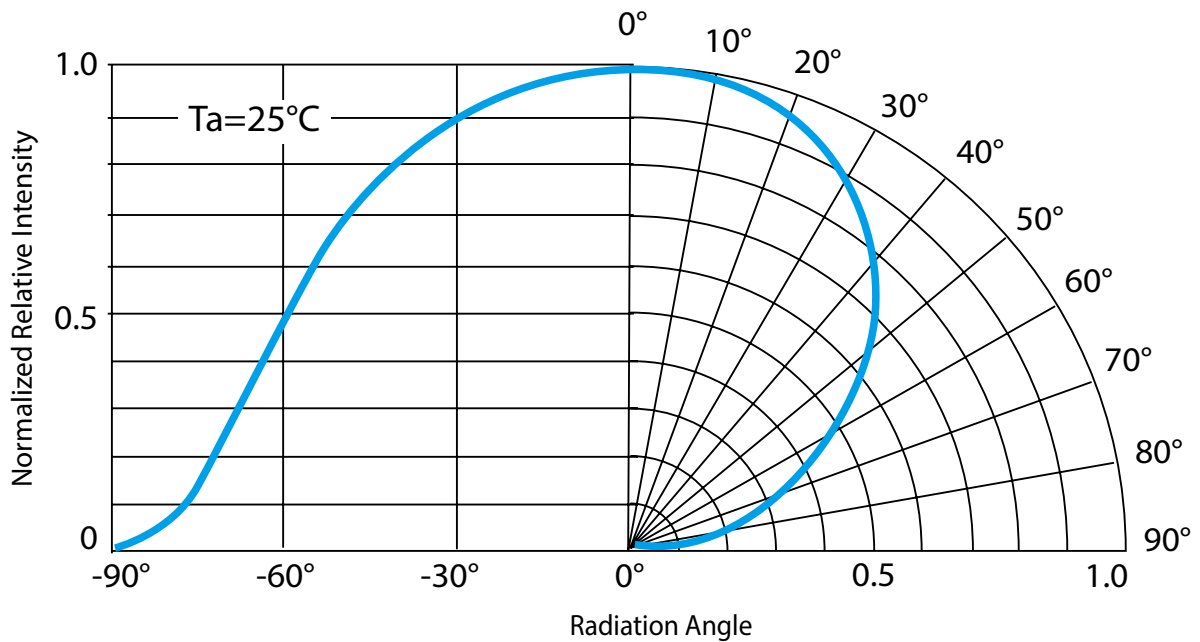

### Forward Current vs. Forward Voltage

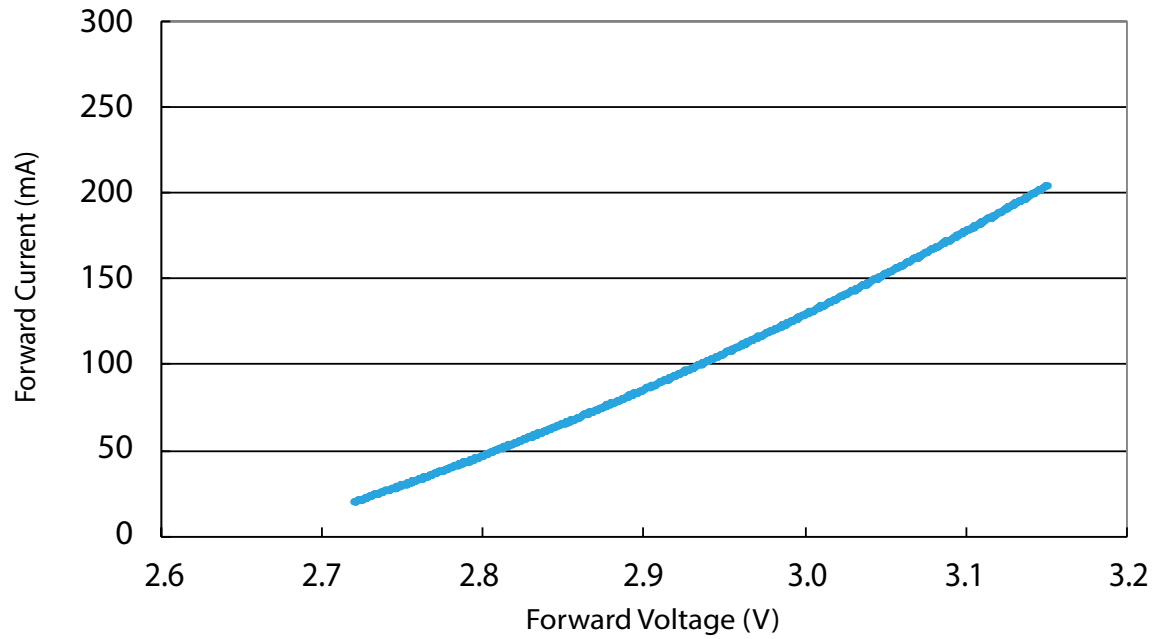

### Relative Luminous Intensity vs. Forward Current

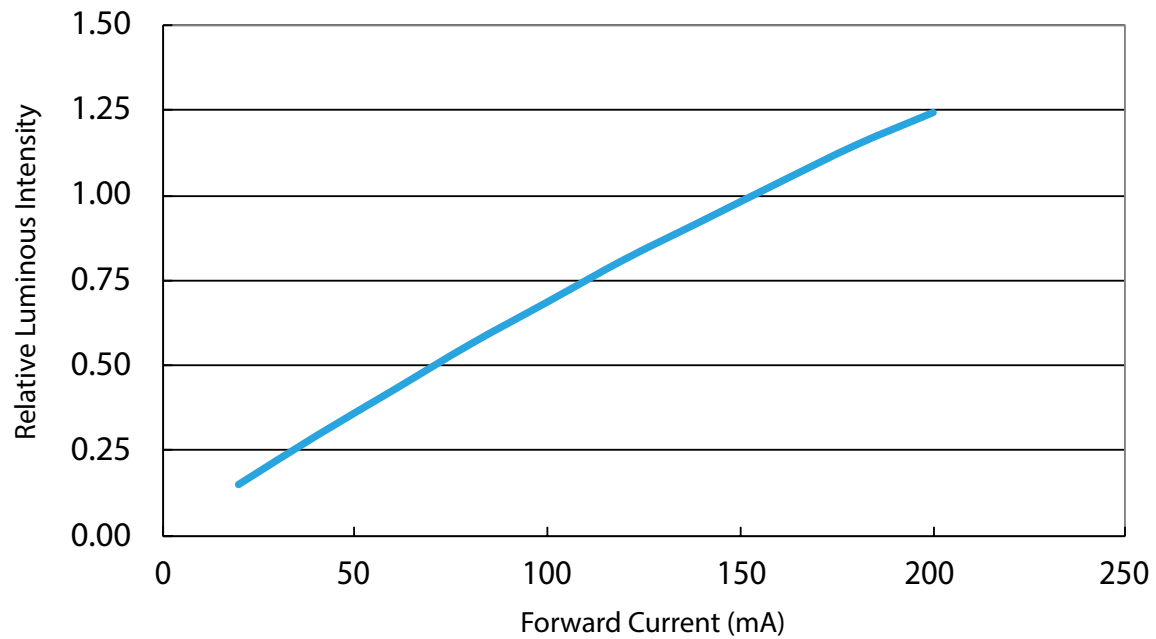

### Relative Luminous Flux vs. Junction Temperature

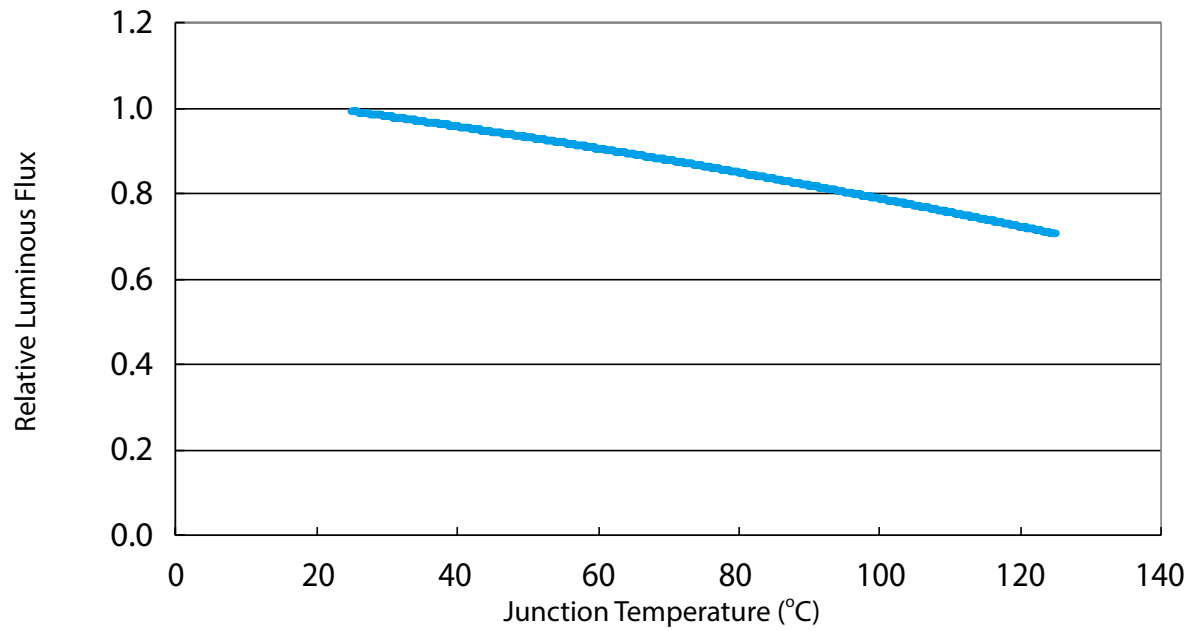

### Forward Voltage vs. Junction Temperature

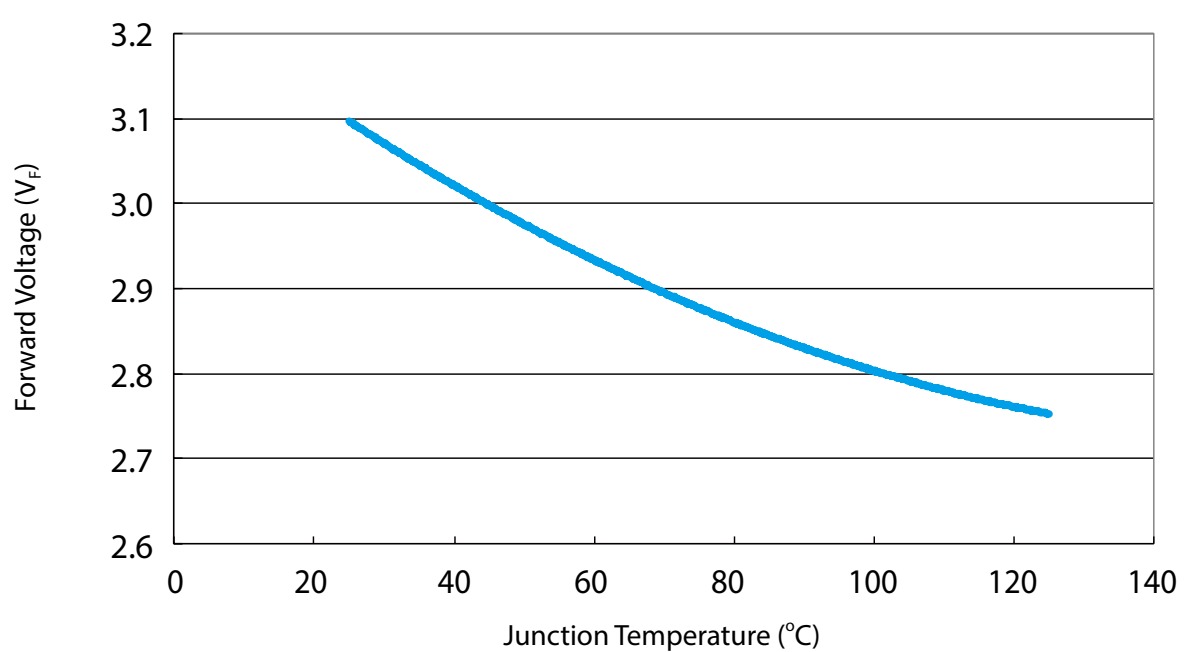

### $\Delta x, \Delta y$ vs. Forward Current

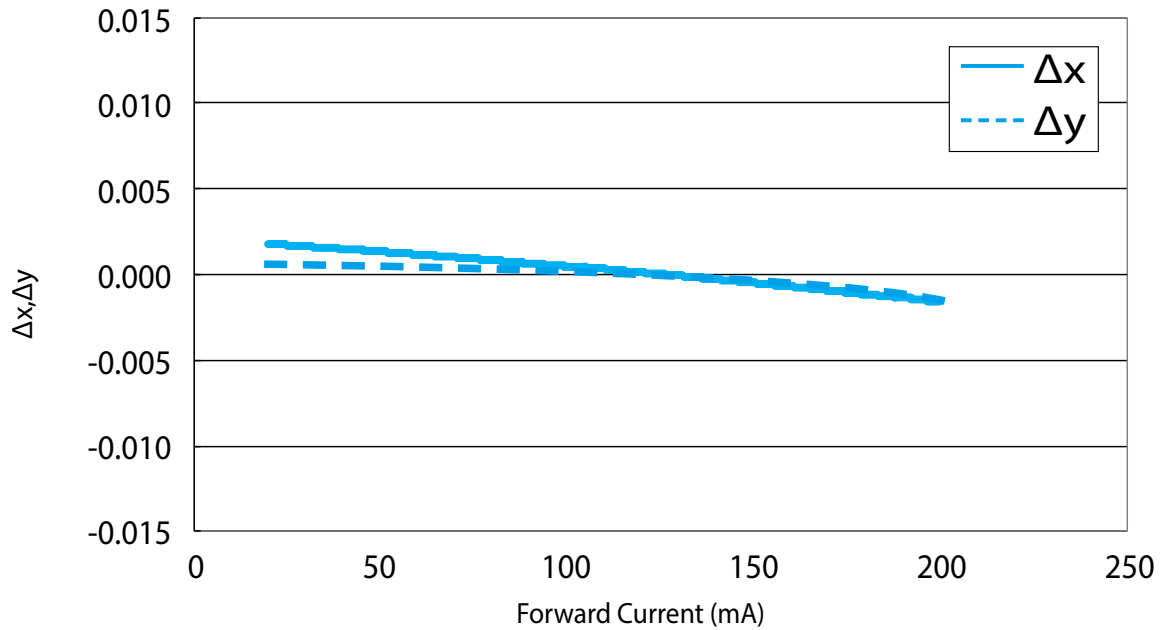

### $\Delta x, \Delta y$ vs. Junction Temperature

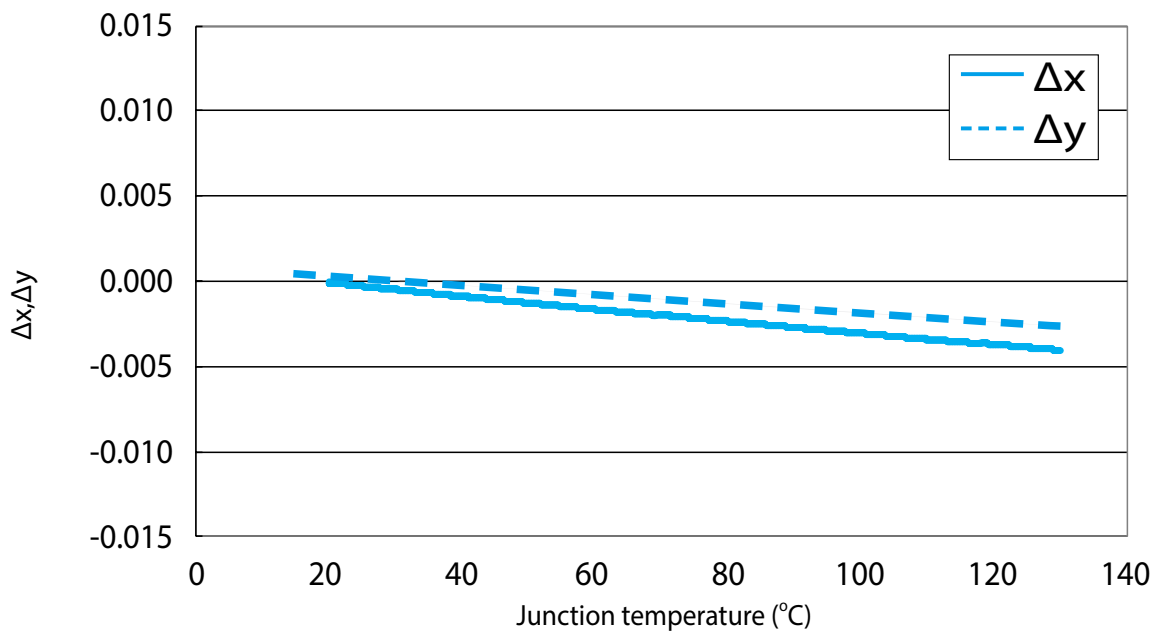

### Maximum Current vs. Ambient Temperature

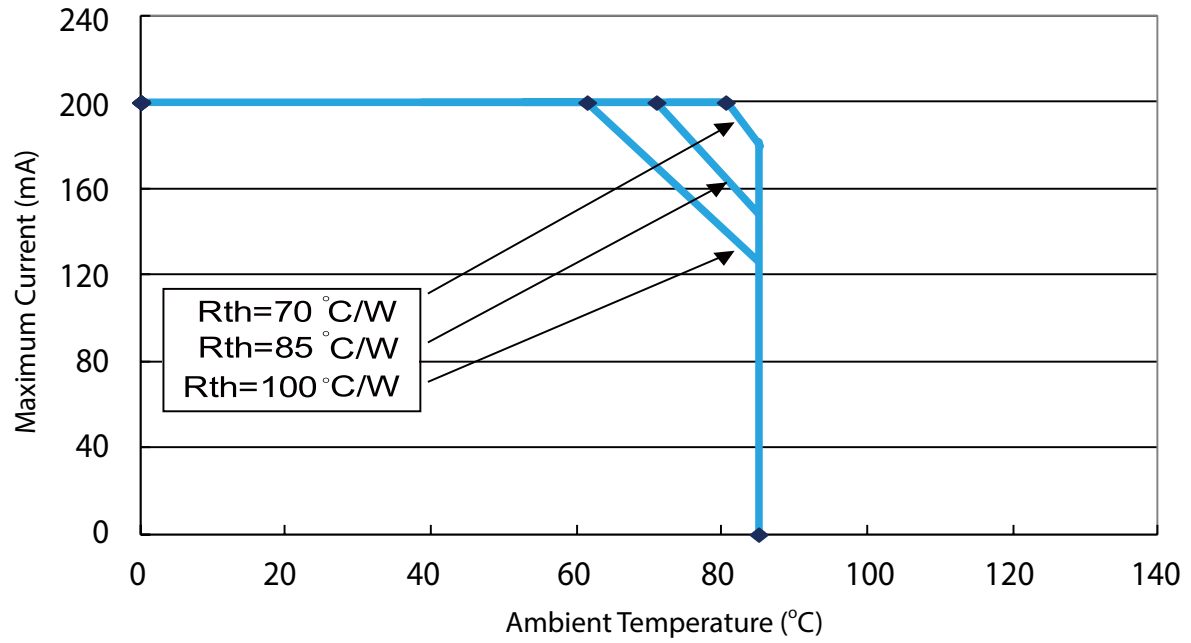

## Reflow Profile

The following reflow profile is from IPC/JEDEC J-STD-020D which provided here for reference.

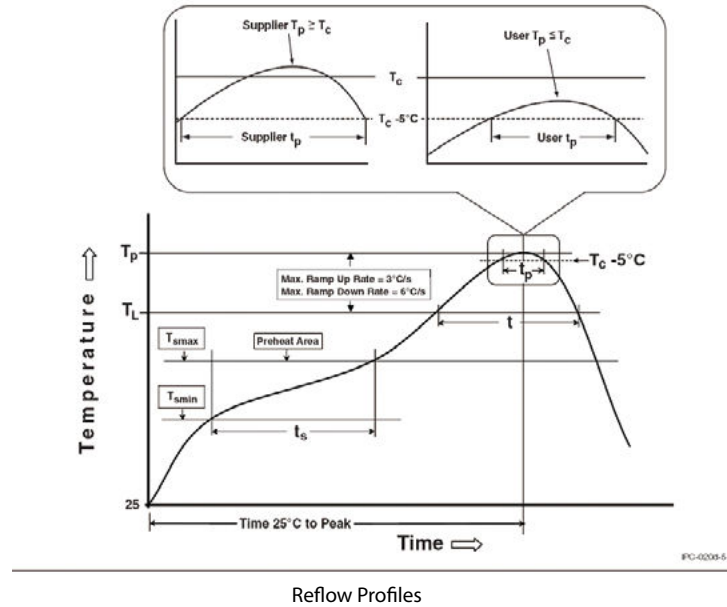

## Classification Reflow Profiles

Profile Feature	Pb-Free Assembly
Preheat & Soak	
Temperature min ( $T_{smin}$ )	150 °C
Temperature max ( $T_{smax}$ )	200 °C
Time ( $T_{smin}$ to $T_{smax}$ ) ( $t_s$ )	60-120 seconds
Average ramp-up rate ( $T_{smax}$ to $T_p$ )	3 °C/second max.
Liquidous temperature ( $T_L$ )	217 °C
Time at liquidous ( $t_L$ )	60-150 seconds
Peak package body temperature ( $T_p$ )*	255 °C ~260 °C *
Classification temperature ( $T_c$ )	260 °C
Time ( $t_p$ )** within 5 °C of the specified classification temperature ( $T_c$ )	30** seconds
Average ramp-down rate ( $T_p$ to $T_{smax}$ )	6°C/second max.
Time 25°C to peak temperature	8 minutes max.

Notes:

- \* Tolerance for peak profile temperature ( $T_p$ ) is defined as a supplier minimum and a user maximum.
- \*\* Tolerance for time at peak profile temperature ( $t_p$ ) is defined as a supplier minimum and a user maximum.

## Reliability

NO .	Test Item	Test Condition	Remark
1	Temperature Cycle	-40°C~100°C 30, 30, mins	100 Cycle
2	Thermal Shock	-40°C~100°C 15, 15 mins ≤ 10 sec	100 Cycle
3	Resistance to Soldering Heat	T <sub>SOL</sub> =260°C, 30 sec	3 times
4	Moisture Resistance	25°C~65°C 90% RH 24 hrs / 1 cycle	10 Cycle
5	High-Temperature Storage	T <sub>A</sub> =100°C	1,000 hrs
6	Humidity Heat Storage	T <sub>A</sub> =85°C RH=85%	1,000 hrs
7	Low-Temperature Storage	T <sub>A</sub> =-40°C	1,000 hrs
8	Operation Life test	25°C	1,000 hrs
9	High Temperature Operation Life test	85°C	1,000 hrs
10	High Humidity Heat Life Test	85°C, 85%RH	1,000 hrs
11	ON/OFF Test	30 sec ON, 30 sec OFF	1.5W times

## Failure Criteria

Item	Criteria for Judgment	
	Min.	Max.
Lumen Maintenance	85%	-
$\Delta u'v'$	-	0.006
Forward Voltage	-	Initial Data x 1.1
Reverse Current	-	10 $\mu$ A
Resistance to Soldering Heat	No dead lamps or visual damage	

## Product Packaging Information

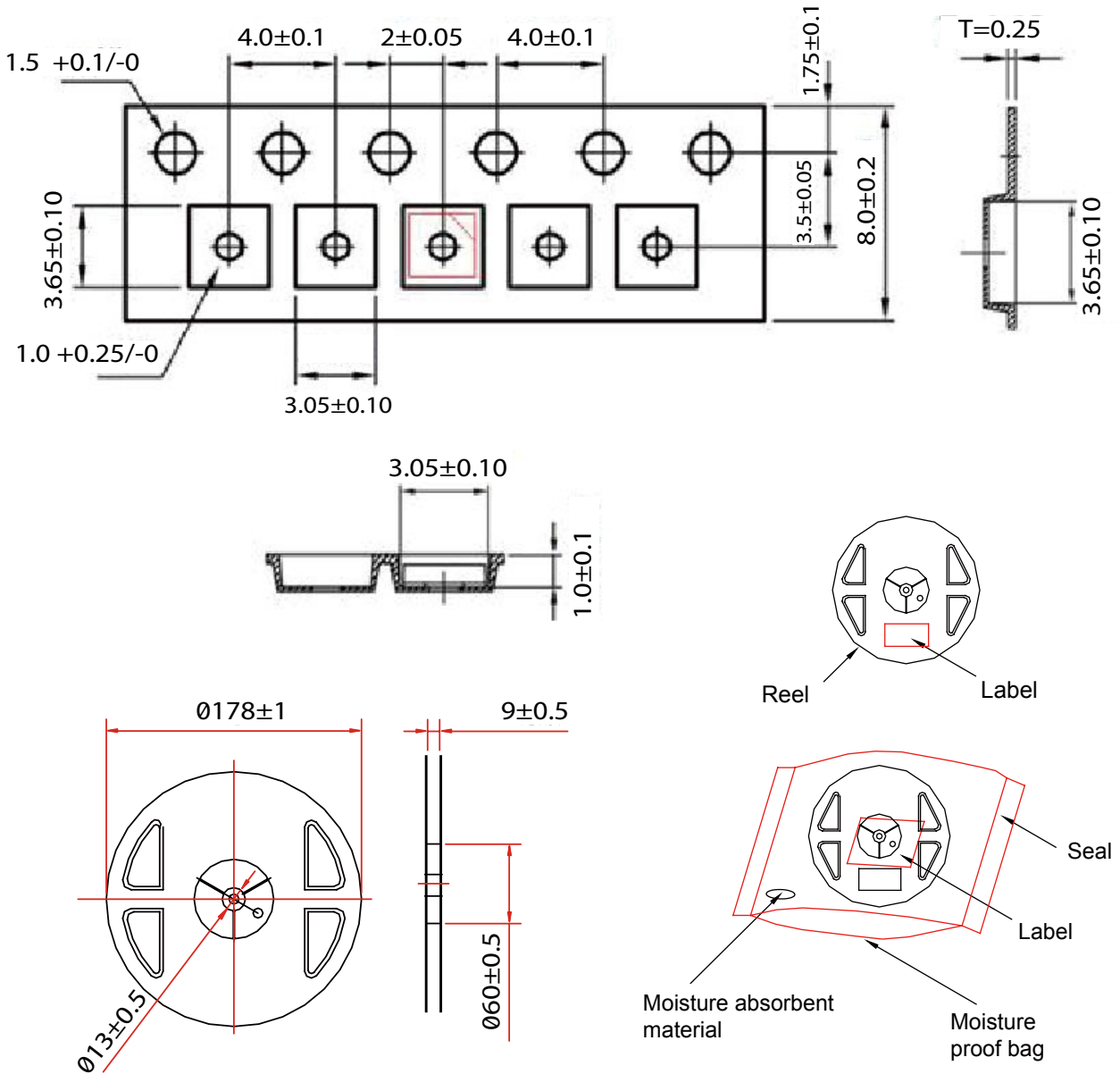

Item	Quantity	Total	Dimensions(mm)
Reel	4,000pcs	4,000pcs	R=178
Starting with 150pcs empty, and 150pcs empty at the last			

## Revision History

Versions	Description	Release Date
1	Preliminary	2016/11/04
2	Redefine CRI	2017/12/06

## About Edison Opto

Edison Opto is a leading manufacturer of high power LED and a solution provider experienced in LDMS. LDMS is an integrated program derived from the four essential technologies in LED lighting applications- Thermal Management, Electrical Scheme, Mechanical Refinement, Optical Optimization, to provide customer with various LED components and modules. More Information about the company and our products can be found at [www.edison-opto.com](http://www.edison-opto.com)

Copyright©2017 Edison Opto. All rights reserved. No part of publication may be reproduced or transmitted in any form or by any means, electronic or mechanical, including photo copy, recording or any other information storage and retrieval system, without prior permission in writing from the publisher. The information in this publication are subject to change without notice.

[www.edison-opto.com](http://www.edison-opto.com)

For general assistance please contact:  
[service@edison-opto.com.tw](mailto:service@edison-opto.com.tw)

For technical assistance please contact:  
[LED.Detective@edison-opto.com.tw](mailto:LED.Detective@edison-opto.com.tw)