

## DETAILS

<b>Product Number</b>	F15524_LINNEA-60
<b>Family</b>	Linnea
<b>Type</b>	Lens
<b>Color</b>	clear
<b>Diameter</b>	280x40 mm
<b>Height</b>	12 mm
<b>Style</b>	rectang
<b>Optic Material</b>	PC
<b>Holder Material</b>	
<b>Fastening</b>	
<b>Status</b>	production ready
<b>ROHS Compliant</b>	Yes
<b>Date Updated</b>	25/01/2018



## OPTICAL PROPERTIES

LED	Viewing Angle	Light Beam	Efficiency	cd/lm	Connector
Tridino 1ft 1100lm xxxHE 1R HV	96+58 deg		86 %	0.580	-
XP-E	96+54 deg		83 %	0.590	-
NF2x757G	sim: 59+90		sim: 85 %	sim: 0.630	-
NFSx757G	96+59 deg		83 %	0.560	-
PrevaLED Linear Slim 3 (1100lm)	97+59 deg		84 %	0.550	-
PrevaLED Linear Slim 3 (2000lm)	96+58 deg		84 %	0.570	-
Duris S5 (2 chip)	95+57 deg		85 %	0.580	-
Duris S5 (Single chip)	96+57 deg		86 %	0.590	-
Fortimo LED Strip 1ft 1100lm FC HV4 & L	96+59 deg		85 %	0.580	-
Fortimo LED Strip 1ft 650lm FC HV4 & L	96+59 deg		84 %	0.570	-
LM561B Plus	96+59 deg		85 %	0.560	-
LT-V282E	96+54 deg		86 %	0.610	-
LT-V562E	96+54 deg		86 %	0.610	-
LT-H282C	96+55 deg		85 %	0.600	-
LT-H562C	96+55 deg		85 %	0.600	-
LT-S282H	96+54 deg		85 %	0.600	-
LT-S562H	96+54 deg		85 %	0.600	-
LT-Q282B	95+54 deg		85 %	0.610	-
SEOUL 5630D	73 deg		84 %	0.560	-
SunLike 3030	96+57 deg		86 %	0.600	-
LLE G4 24x280mm 650lm	95+59 deg		85 %	0.570	-
LLE G4 24x280mm 1250lm	96+58 deg		85 %	0.570	-
LLE G4 24x280mm 2000lm ADV	sim: 89+61		sim: 84 %	sim: 0.580	-
CALOSNU405-M7W1	96+55 deg		84 %	0.590	-
CALOSNU410-M7W1	95+55 deg		84 %	0.600	-



## PRODUCT DATASHEET

### Linnea series

last update 25/1/2018

## OPTICAL PROPERTIES

LED	Viewing Angle	Light Beam	Effi- ciency	cd/lm	Connector
-----	------------------	---------------	-----------------	-------	-----------

H G F E D C B A

4

4

3

3

2

2

1

1

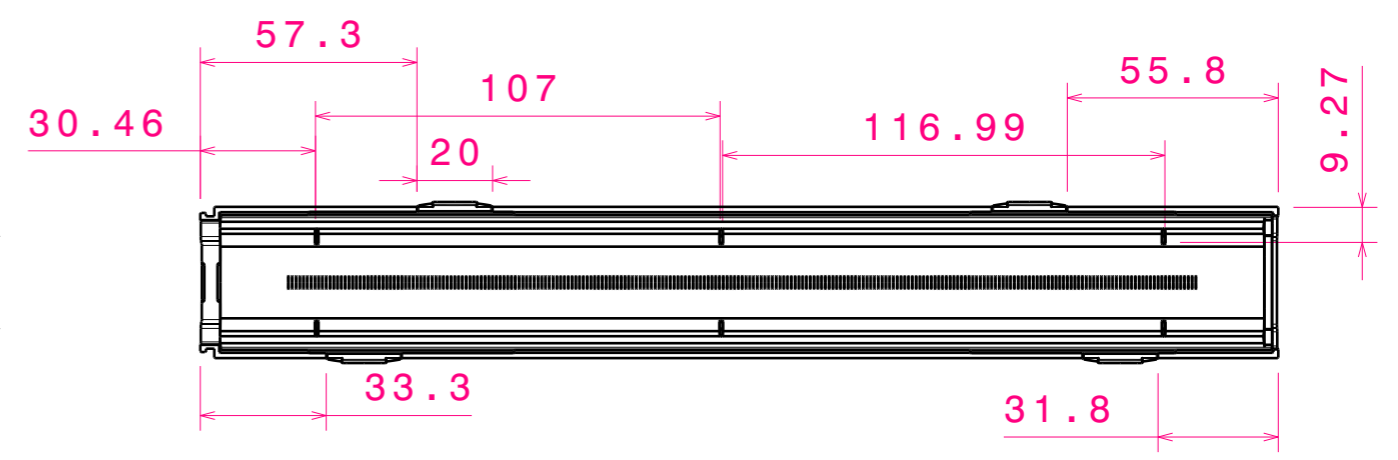
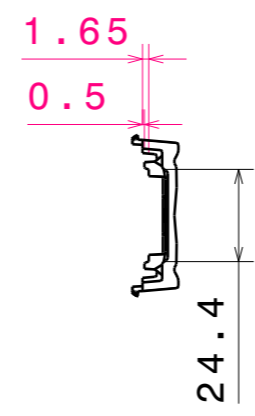
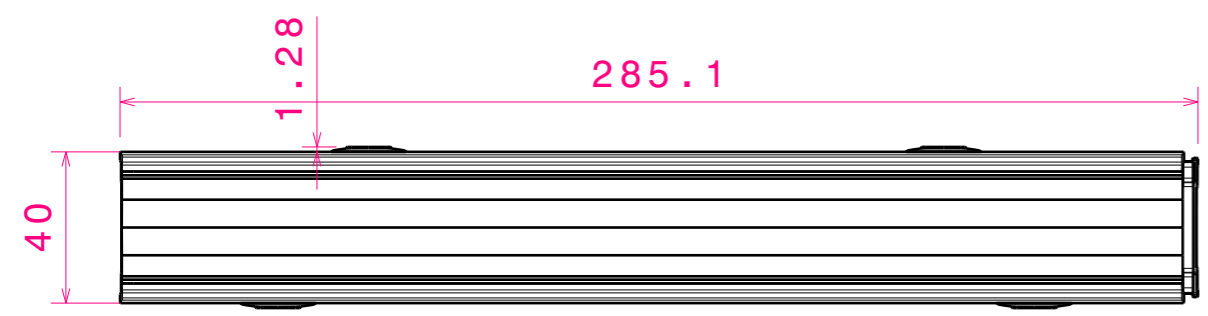
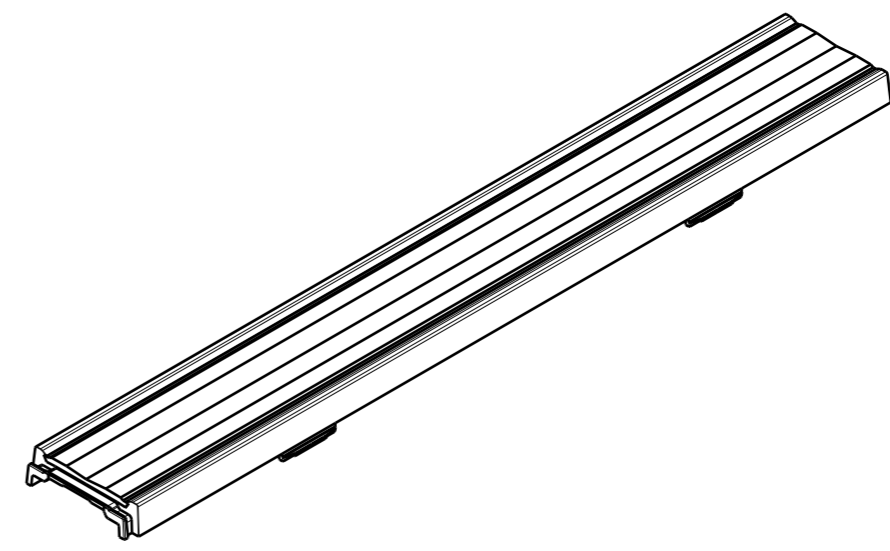
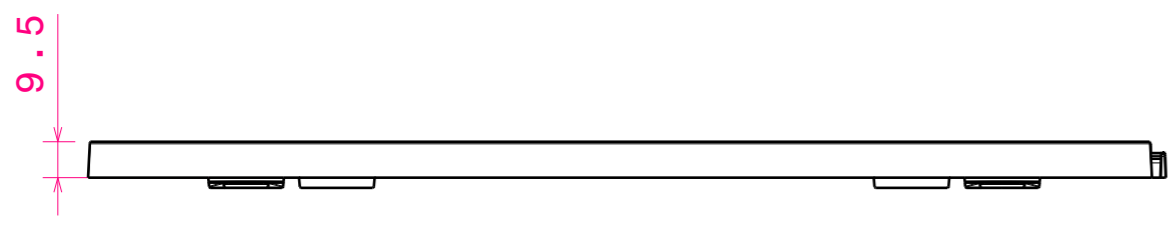

INDEX	PART NO	DESCRIPTION	MATERIAL	COLOUR
1	F15524	LINNEA-60		

Tolerances if not otherwise shown  
 According to DIN ISO 2768-1  
 Linear measures:  
 Up to 30mm class F<sub>M</sub>, otherwise see class MC.  
 According to DIN ISO 2768-2  
 Form and position: class K  
 Control for SPC marked dimensions.

**LEDiL** LediL Oy  
 Salorankatu 10  
 FIN 24240 SALO  
 Finland

THIRD ANGLE PROJECTION:

DRAWING TITLE  
**F15524\_LINNEA-60**

This drawing is the property  
 of LEDiL Oy. It may not be  
 reproduced, copied or  
 communicated without a written  
 agreement with LEDiL Oy.

SIZE	PART NUMBER		
<b>A3</b>	<b>F15524</b>		

SCALE	1:1	WEIGHT	-	SHEET	1/1
-------	-----	--------	---	-------	-----

H G B A

Luminaire: Ledil F15524\_LINNEA-60\_(Tridino\_1ft\_1100lm\_840HE\_1R\_HV)

Lamps: 1 x Tridino\_1ft\_1100lm\_840HE\_1R\_HV\_(Edison2835HE)\_1343.19lm@250mA\_P=8.02229W\_I=0.250A

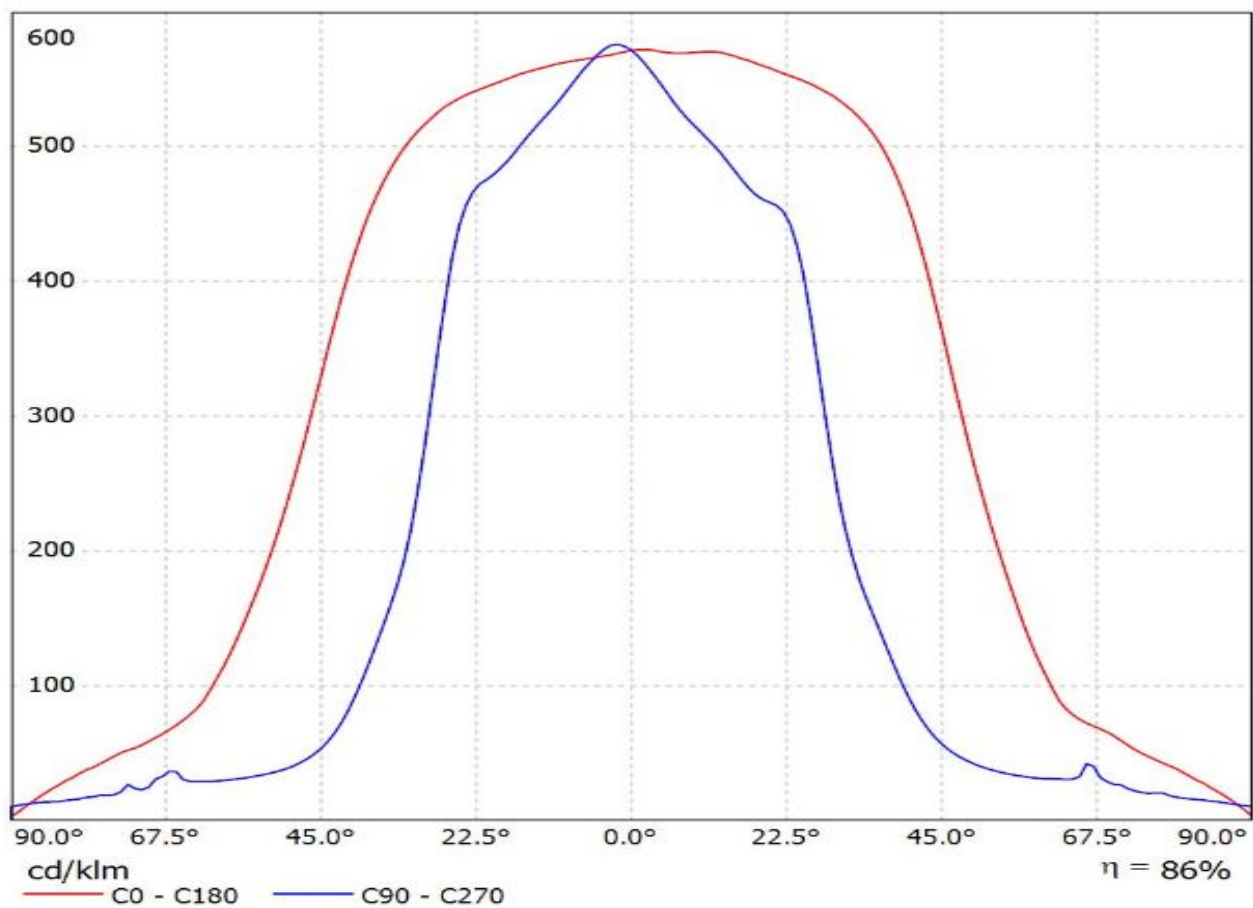

Luminaire: LEDiL Oy F15524\_LINNEA-60\_(XP-E)

Lamps: 1 x Cree\_XP-E\_x12\_(XPEWHT-L1-3C0-Q5-0-00)\_920.665lm@250mA\_P=9.07548W\_U=36.329V

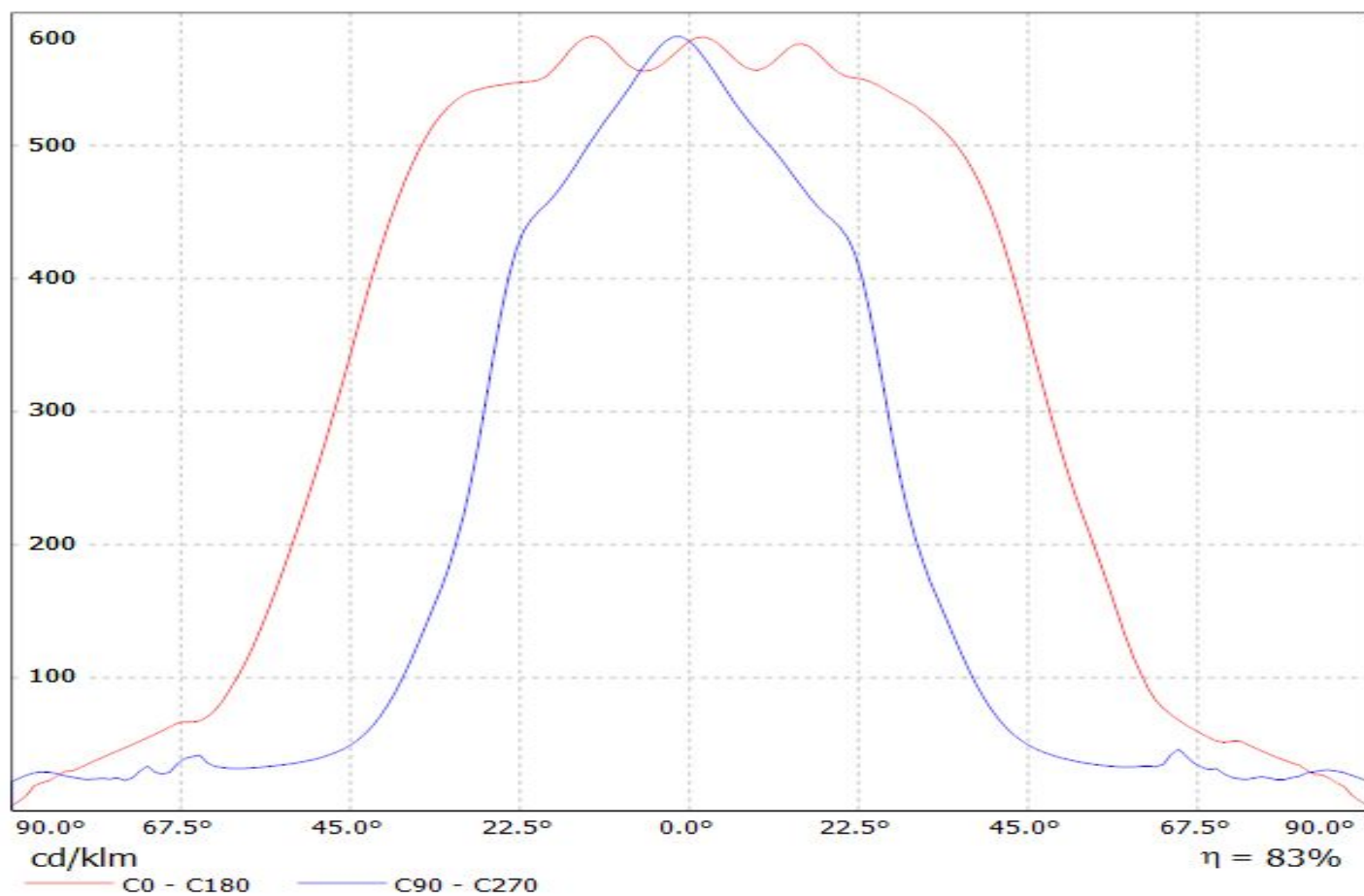

Luminaire: Ledil Oy F15524\_LINNEA-60\_(NF2W757GR-V1)\_SIMULATED  
Lamps: 1 x Nichia NF2W757GR-V1

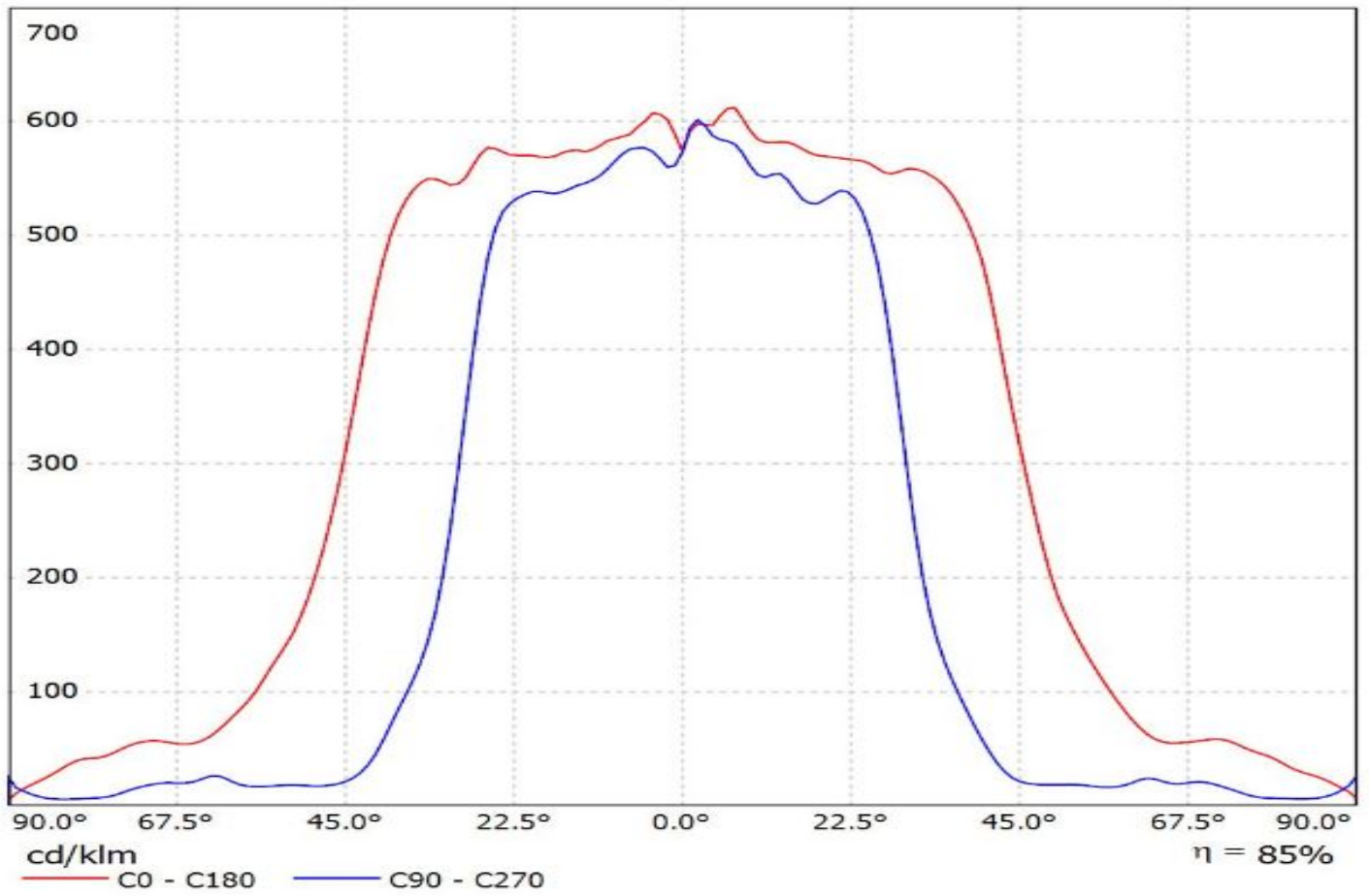

Luminaire: LEDiL Oy F15524\_LINNEA-60\_(NFSx757G)

Lamps: 1 x Nichia\_NFSx757Gx12\_389.068lm@65mA\_P=2.23905W\_U=34.391V

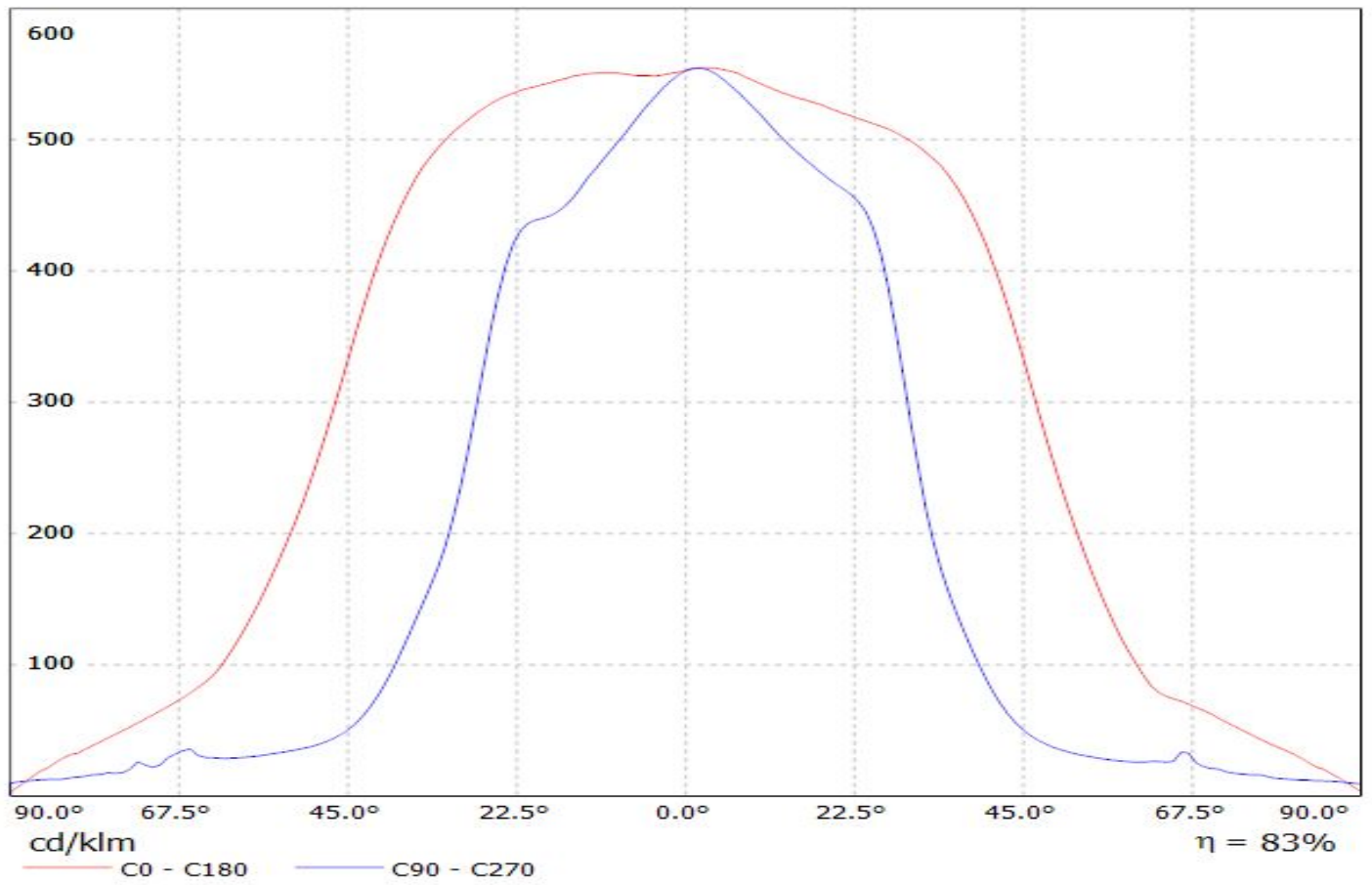

Luminaire: LEDiL Oy F15524\_LINNEA-60\_(Prevaled\_Linear\_Slim\_1100lm)

Lamps: 1 x Osram\_Prevaled\_Linear\_Slim\_1100lm\_(PL-LIN\_S-Z3\_1100-830\_280)\_1027.96lm@170mA\_CCT=3000K\_P=6.43142W\_I=0.250A

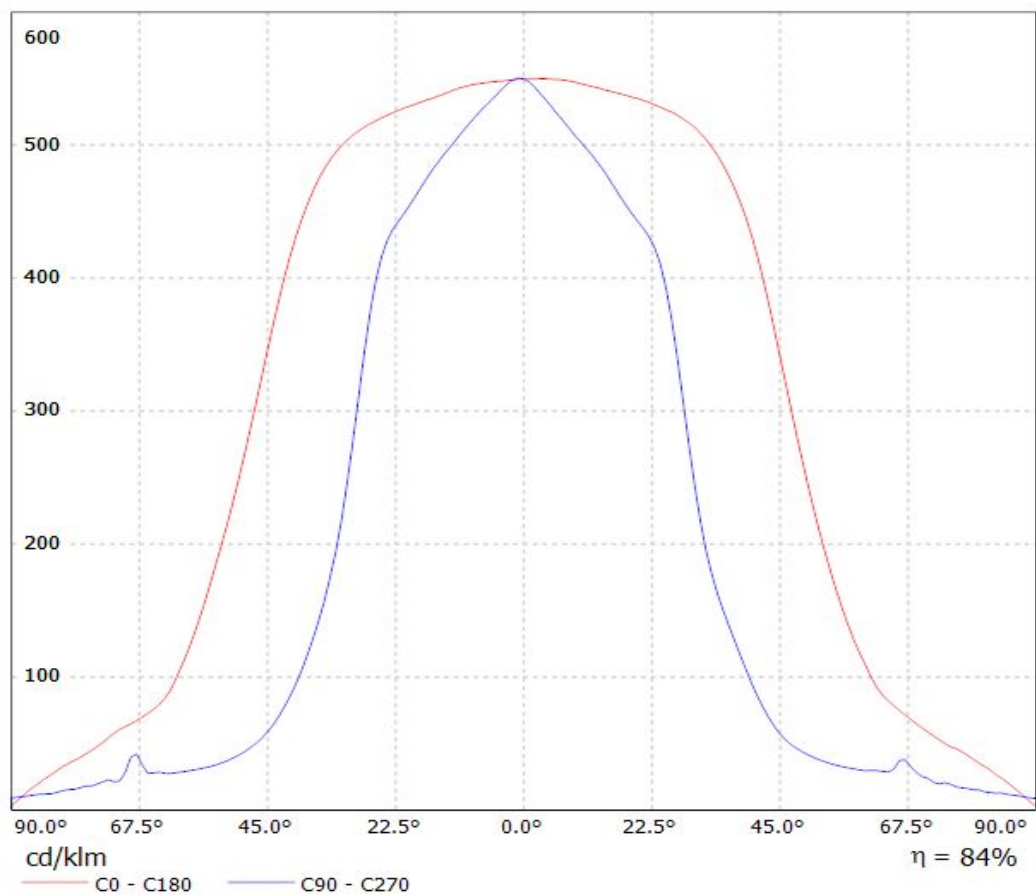

Luminaire: Ledil F15524\_LINNEA-60 (Prevaled\_Linear\_Slim\_3)  
Lamps: 1 x Osram\_Prevaled\_Linear\_Slim\_3 (PL-LIN S-Z3-2000-840-280)  
\_1949.14lm@300mA\_CCT=4000K\_P=12.0015W\_U=40.179V

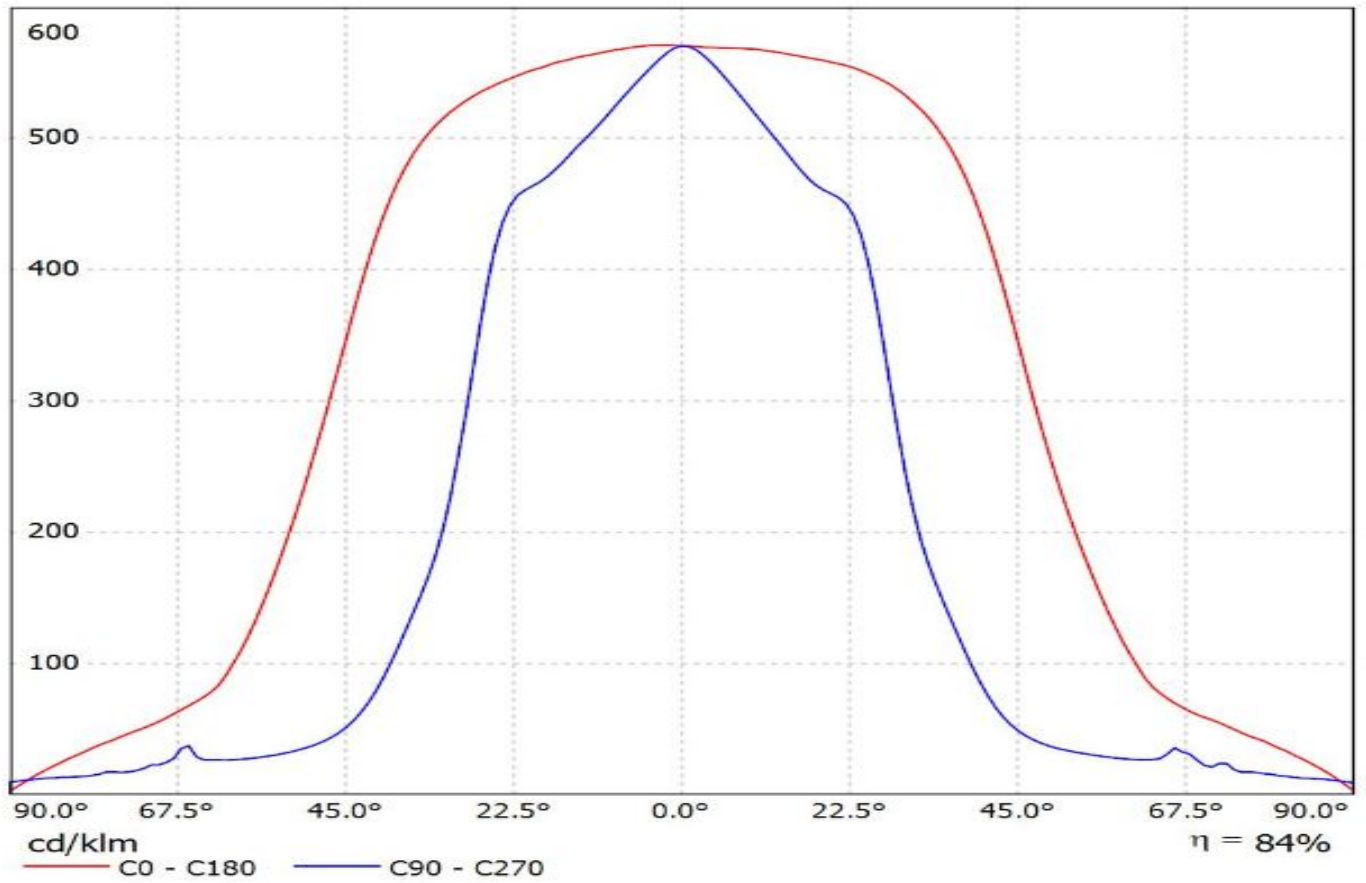

Luminaire: Ledil F15524\_LINNEA-60\_(Duris\_S5)

Lamps: 1 x Osram\_Duris\_S5\_1183.73lm@250mA\_P=8.66003W\_U=34.724V

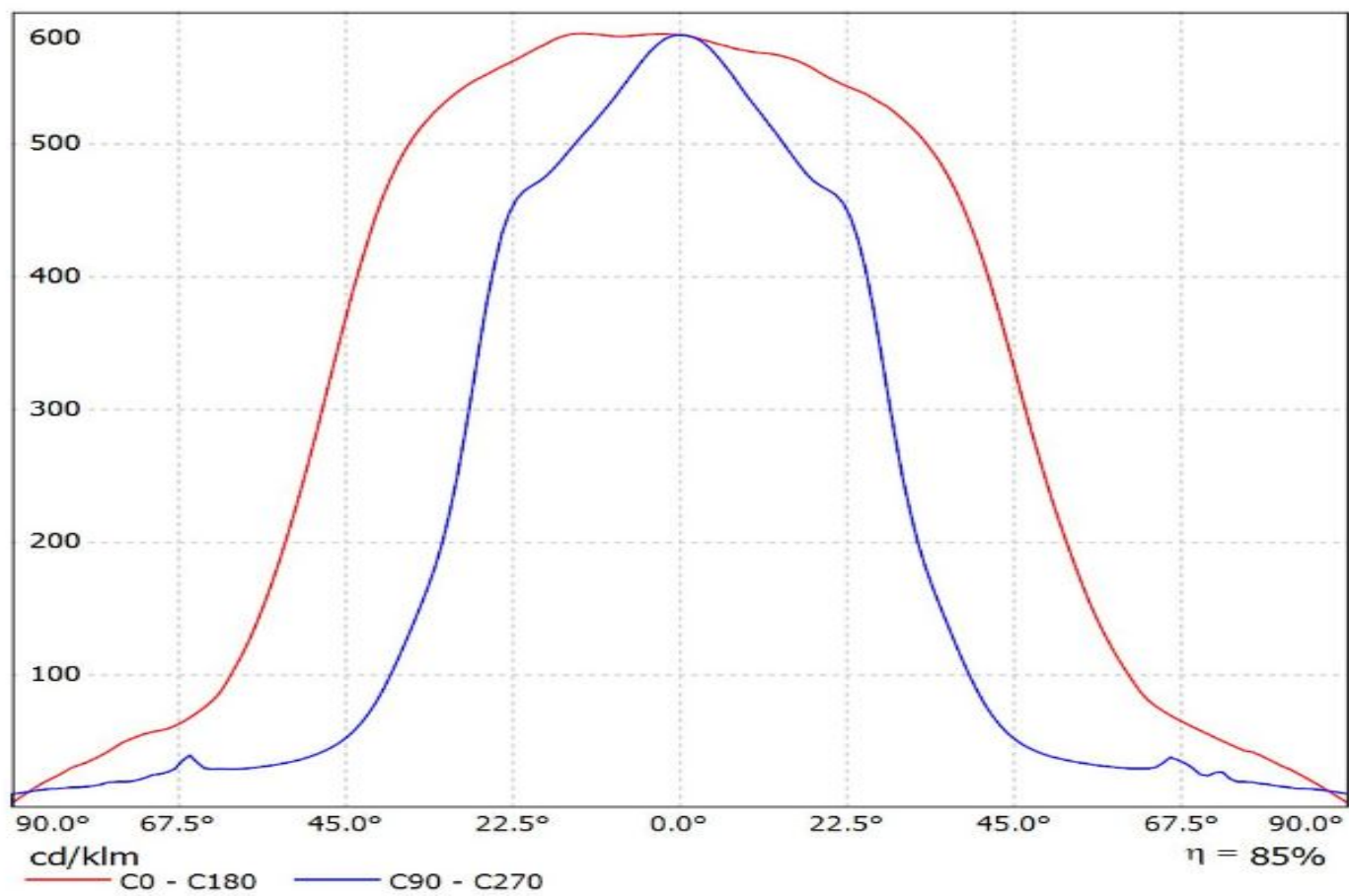

Luminaire: LEDiL Oy F15524\_LINNEA-60\_(Duris\_S5\_1chip)  
Lamps: 1 x Osram\_Duris\_S5\_1chip\_(GWPSLM31\_EM-GUHQ-A535-1)  
\_359.255lm@65mA\_P=2.13817W\_U=33.253V

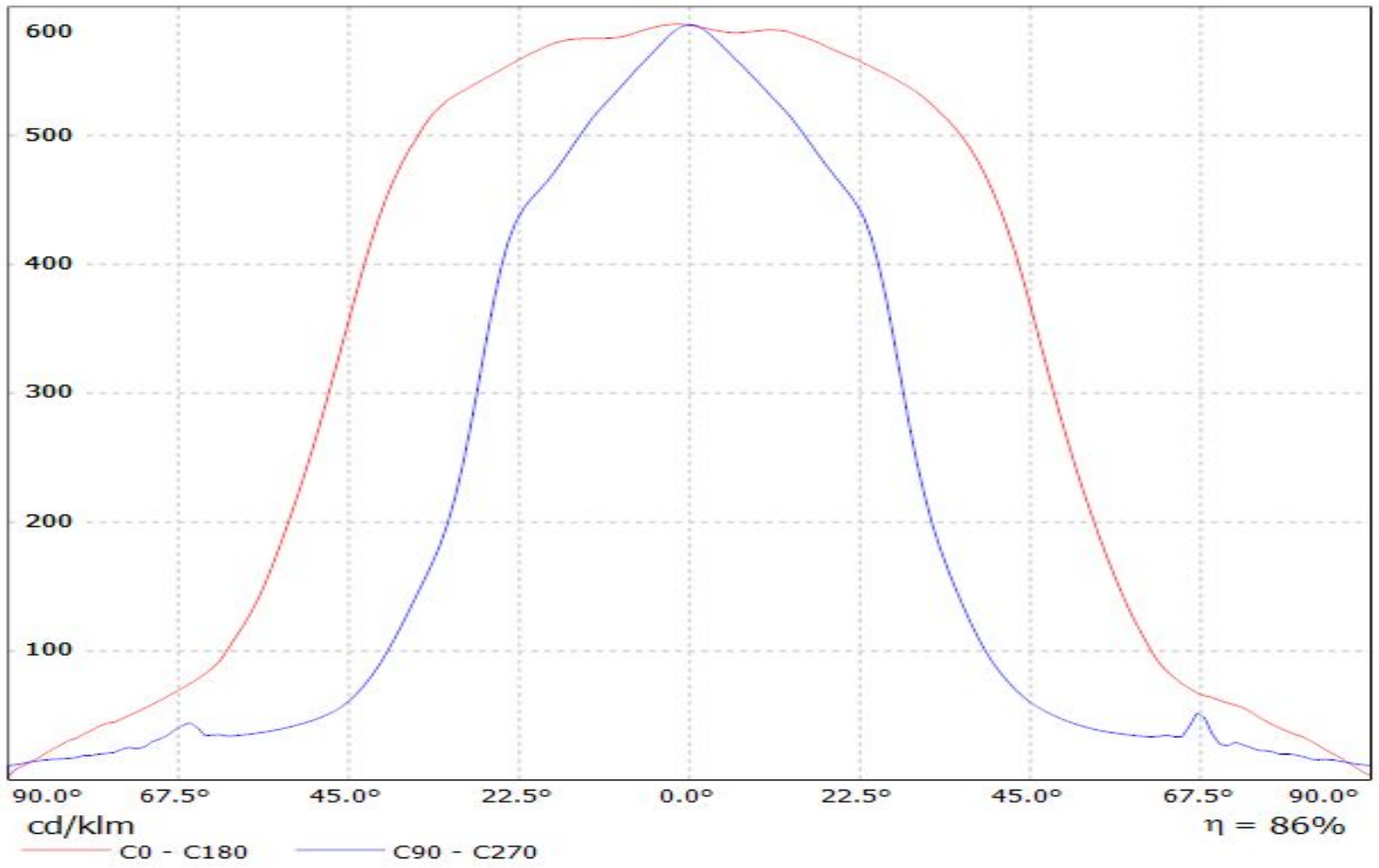

Luminaire: Ledil F15524\_LINNEA-60\_(Fortimo\_LED\_Strip\_1ft\_1100lm\_FC\_HV4)  
Lamps: 1 x Philips\_Fortimo\_LED\_Strip\_1ft\_1100lm\_930\_FC\_HV4\_735.772lm@250mA\_P=5.6145W\_U=22.496V

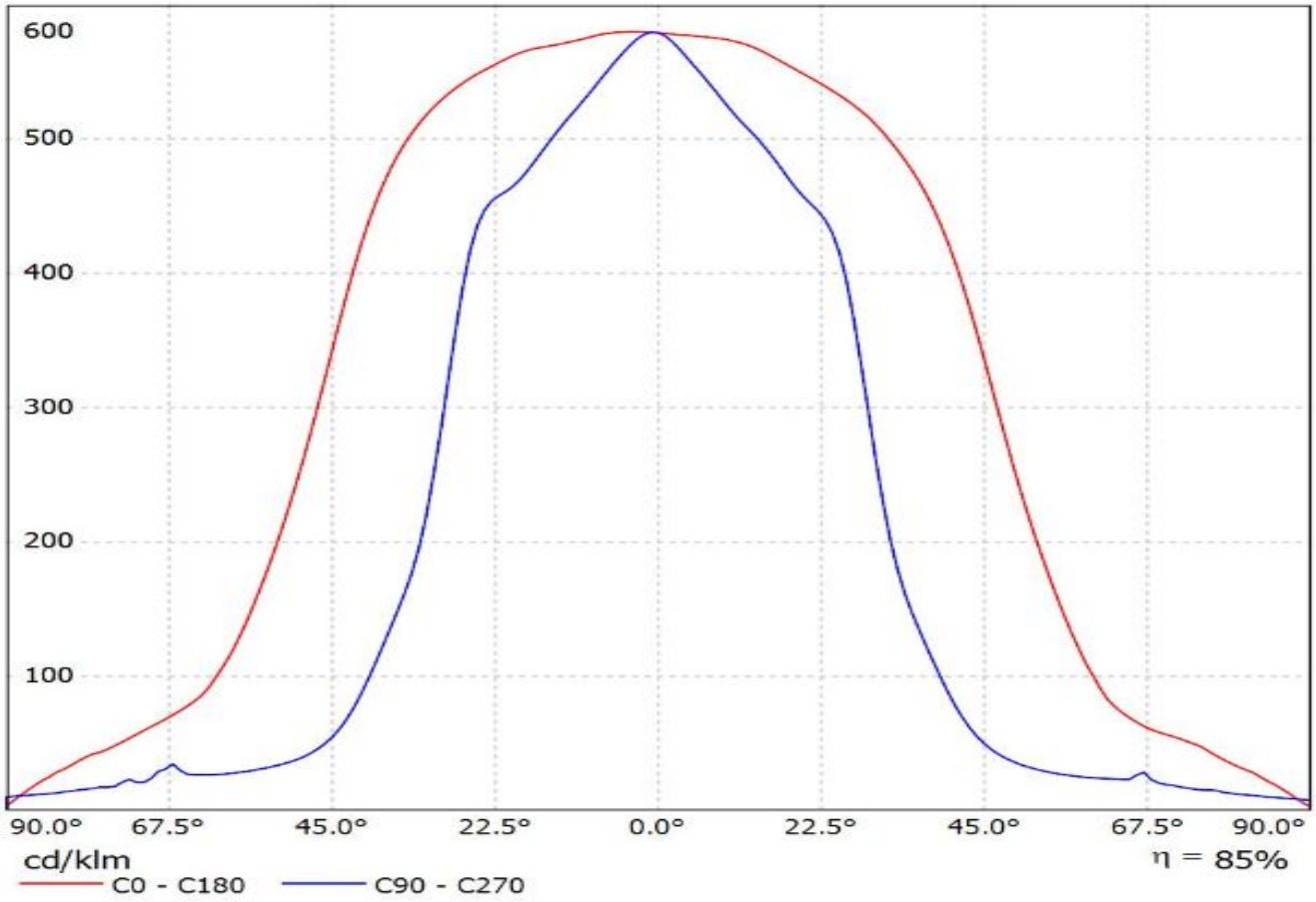

Luminaire: Ledil F15524\_LINNEA-60\_(Fortimo\_LED\_Strip\_1ft\_650lm\_FC\_LV4)

Lamps: 1 x Philips\_Fortimo\_LED\_Strip\_1ft\_650lm\_FC\_LV4\_994.849lm@190mA\_P=6.82273W\_U=35.990V

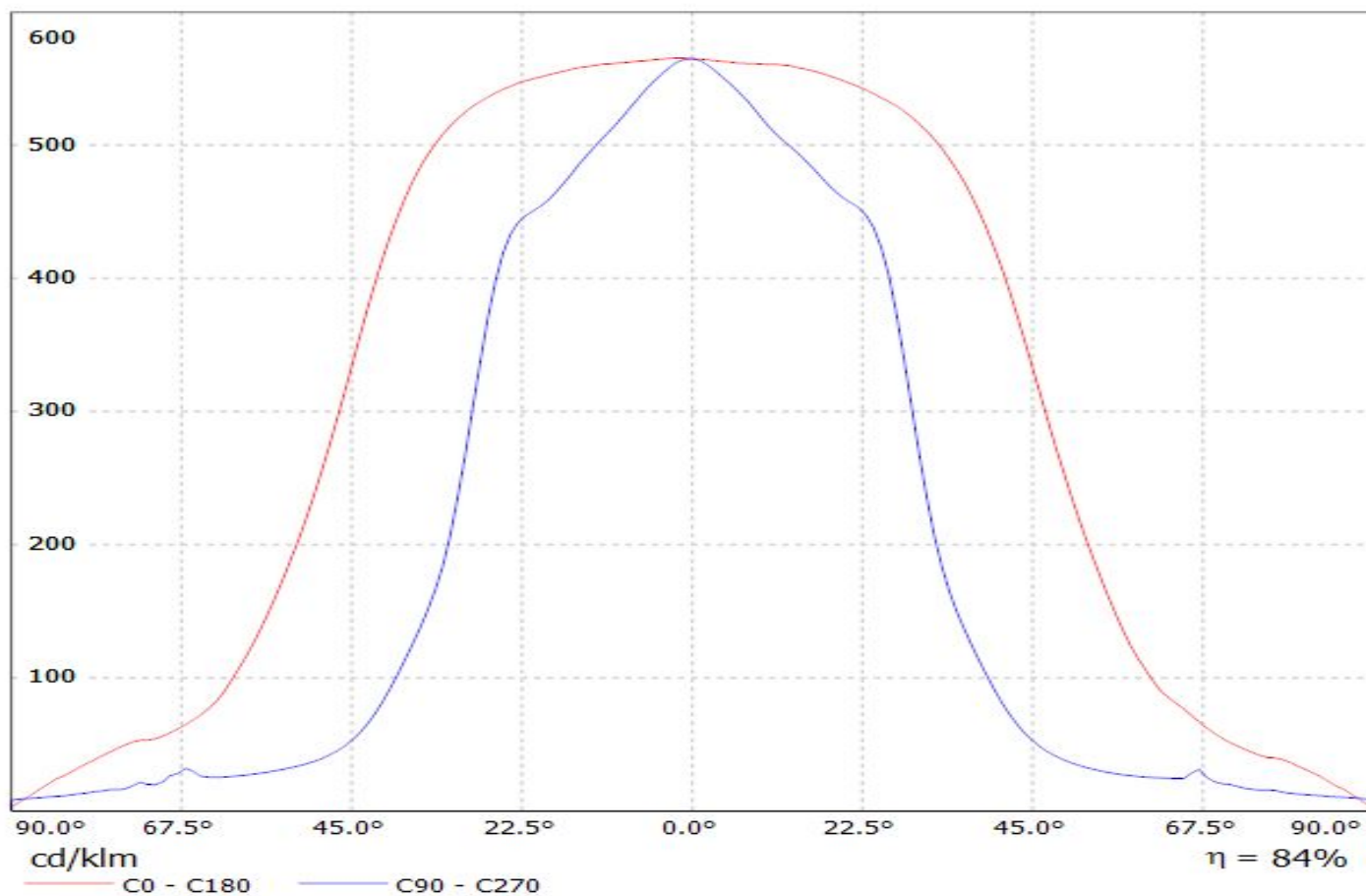

Luminaire: LEDiL Oy F15524\_LINNEA-60\_(LM561B+)\_Cav1  
Lamps: 1 x Samsung\_LM561B+\_1370.33lm@250mA\_P=9.1162W\_I=0.250A

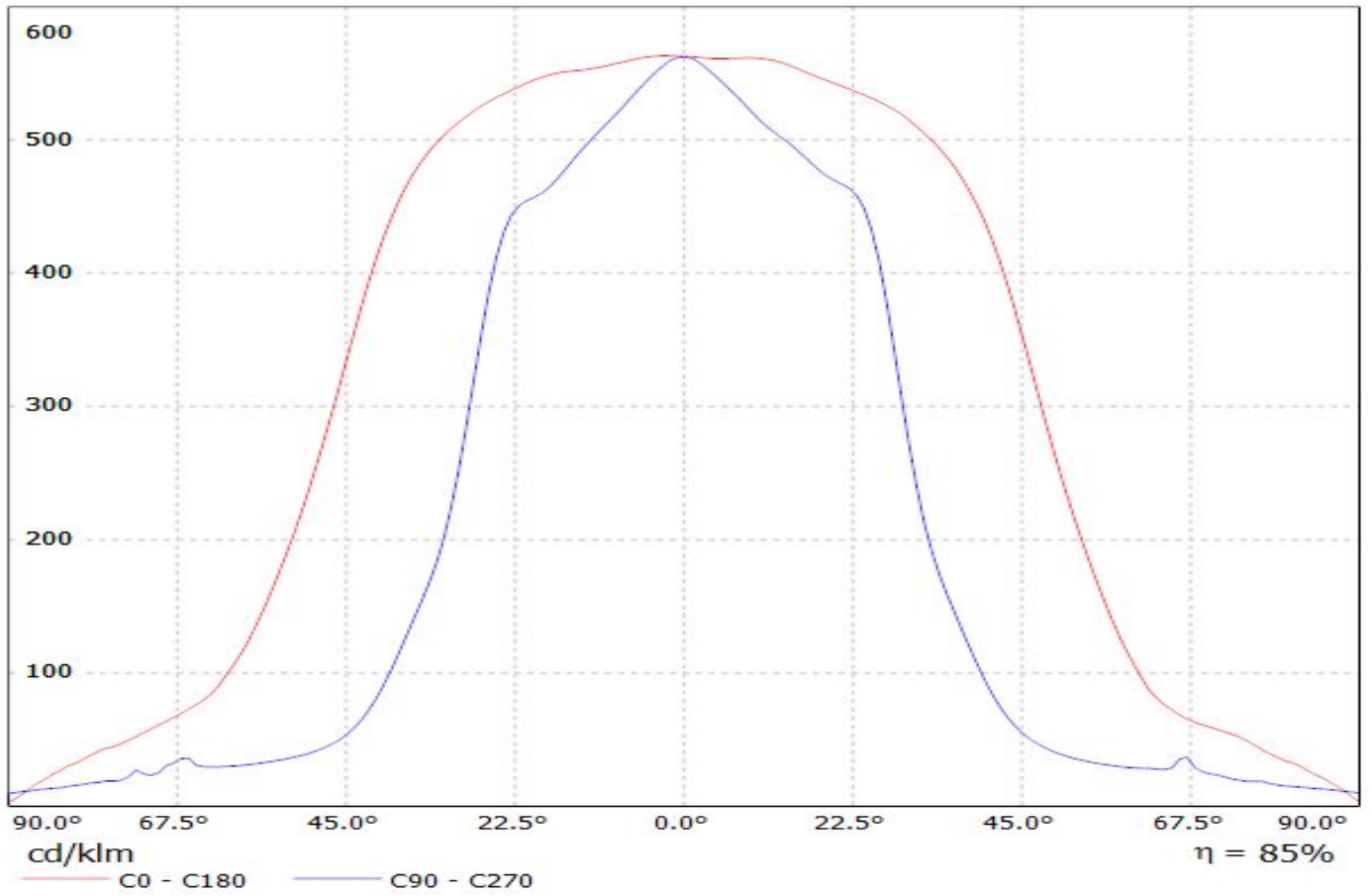

Luminaire: Ledil F15524\_LINNEA-60\_(LT-V282E)

Lamps: 1 x Samsung\_LT-V282E\_(LM281B)\_1072.13lm@300mA\_CCT=4000K\_P=7.1427W\_I=0.30A

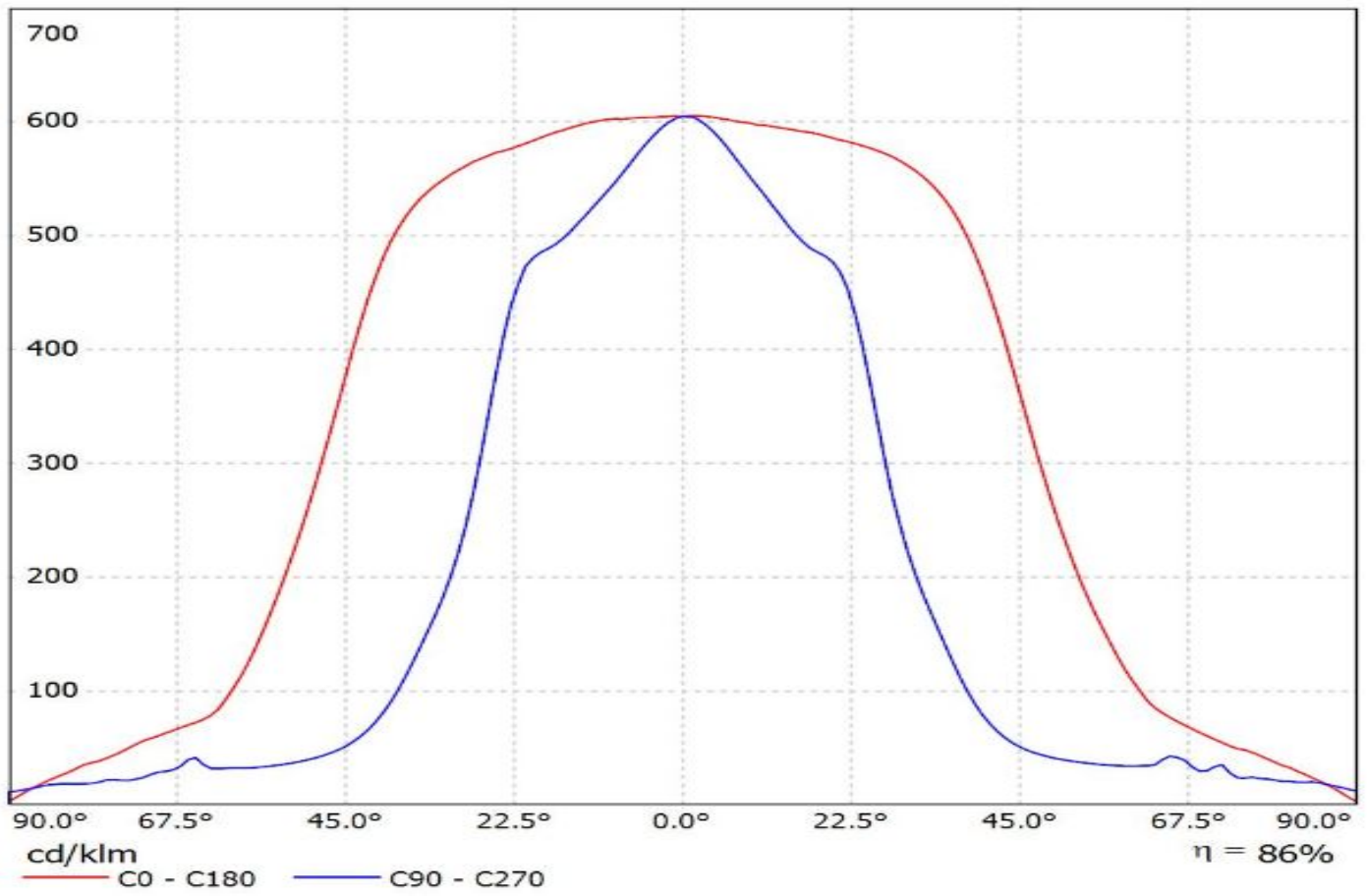

Luminaire: Ledil F15524\_LINNEA-60\_(LT-V562E)

Lamps: 1 x Samsung\_LT-V562E\_(LM281B)\_2144.6lm@300mA\_CCT=4000K\_P=14.2854W\_I=0.30A

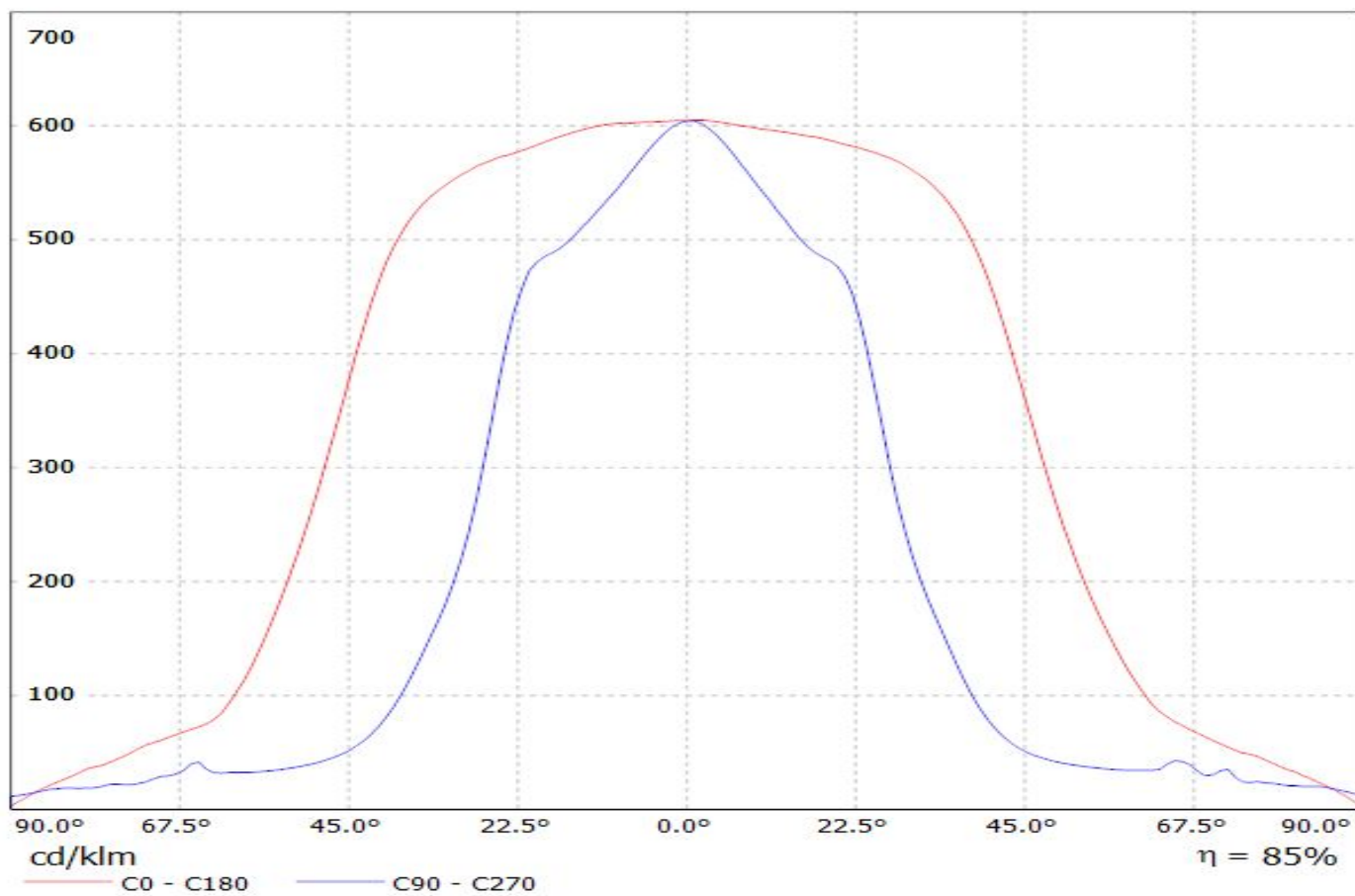

Luminaire: Ledil F15524\_LINNEA-60\_(LT-H282C)

Lamps: 1 x Samsung\_LT-H282C\_(LM561C)\_997.05lm@240mA\_CCT=4000K\_P=5.43445W\_I=0.240A

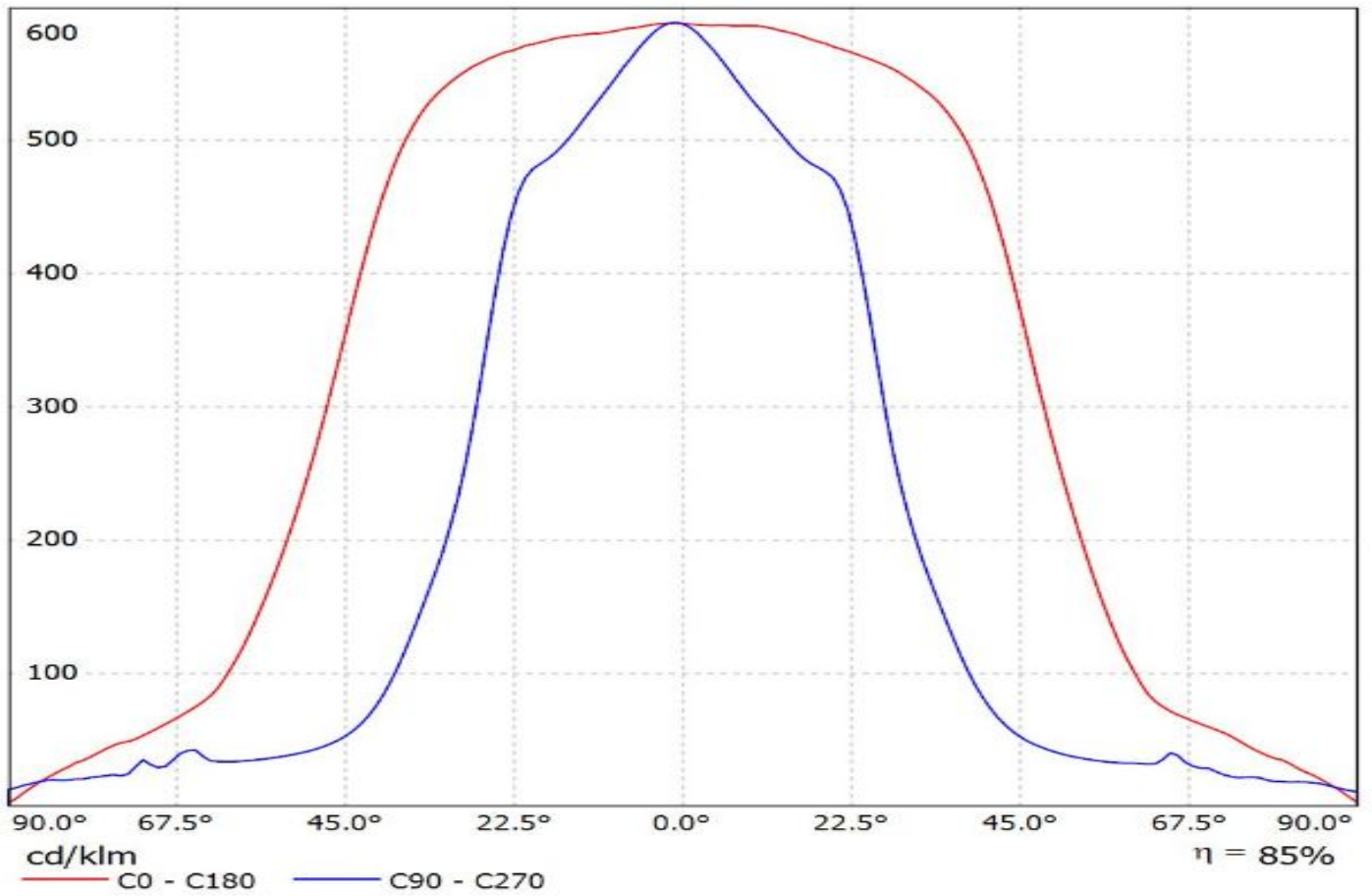

Luminaire: Ledil F15524\_LINNEA-60\_(LT-H562C)

Lamps: 1 x Samsung\_LT-H562C\_(LM561C)\_1994.1lm@240mA\_CCT=4000K\_P=10.8689W\_I=0.240A

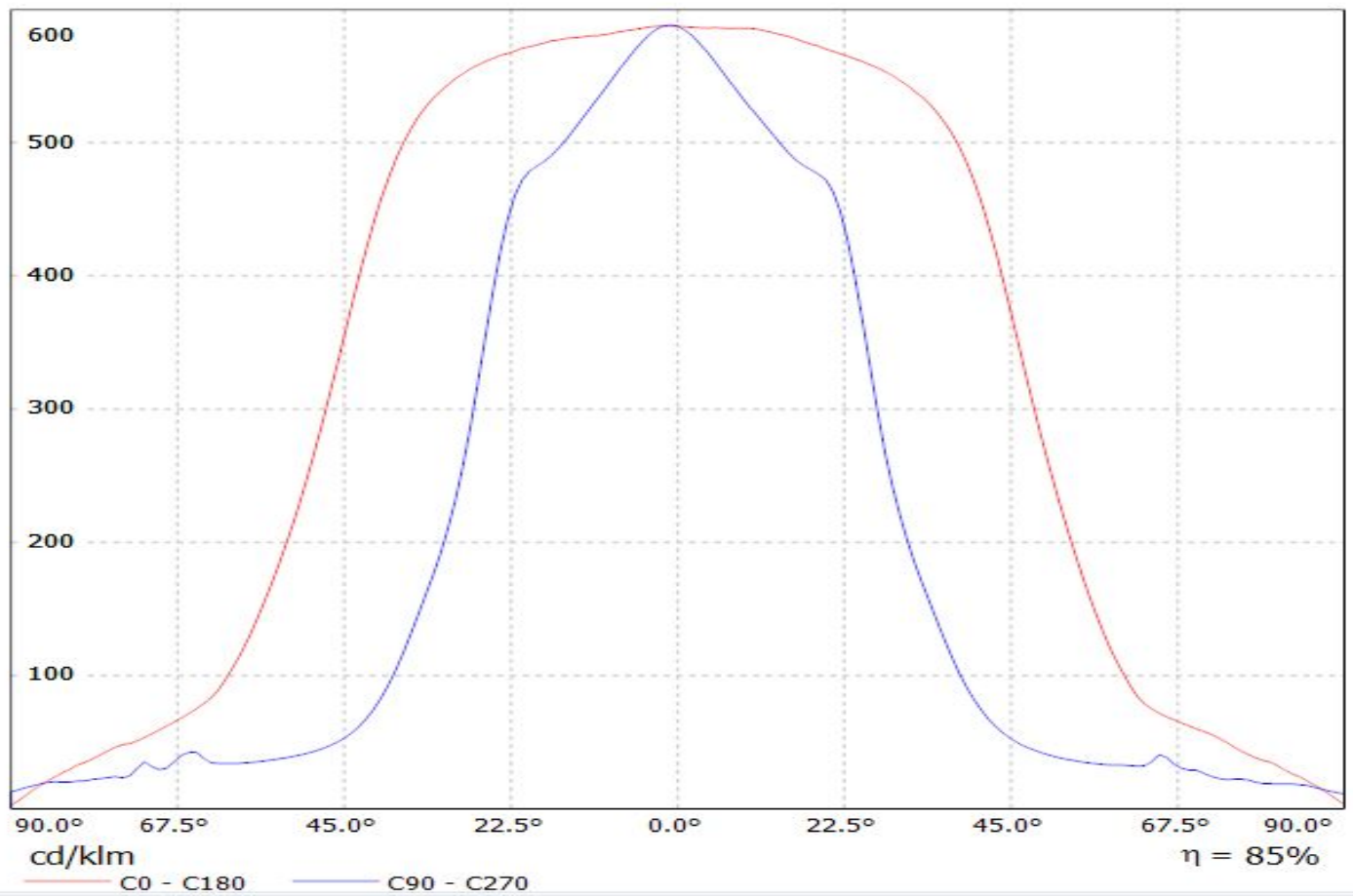

Luminaire: Ledil F15524\_LINNEA-60\_(LT-S282H)

Lamps: 1 x Samsung\_LT-S282H\_(LM561B+)\_1143.31lm@300mA\_P=7.2W\_I=0.30A

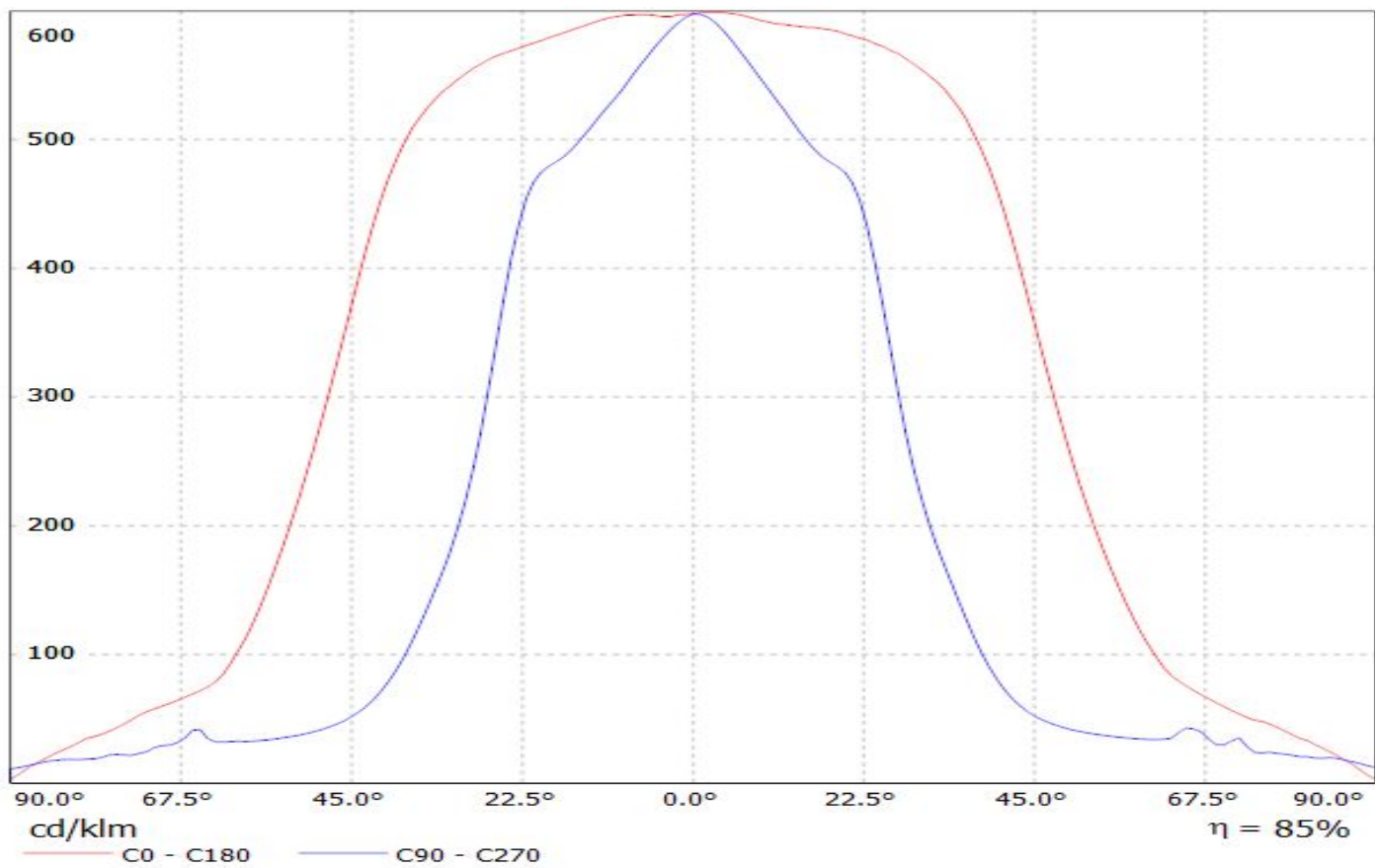

Luminaire: Ledil F15524\_LINNEA-60\_(LT-S562H)

Lamps: 1 x Samsung\_LT-S562H\_(LM561B+)\_2286.62lm@300mA\_P=14.4W\_I=0.30A

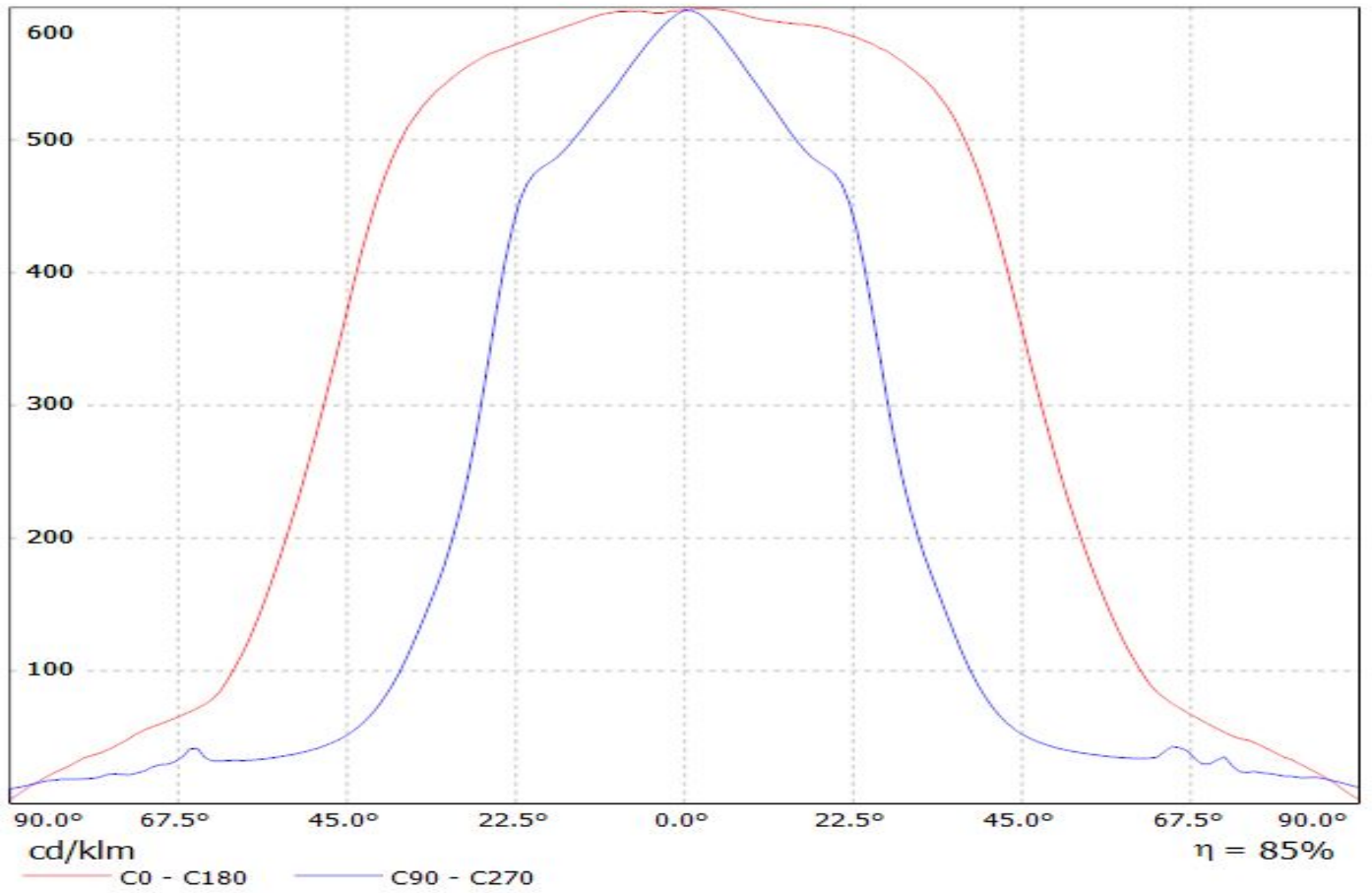

Luminaire: Ledil F15524\_LINNEA-60\_(LT-Q282B)

Lamps: 1 x Samsung\_LT-Q282B\_(LM301B\_SI-B8T053280EU)\_943.526lm@180mA\_P=4.99618W\_U=27.805V

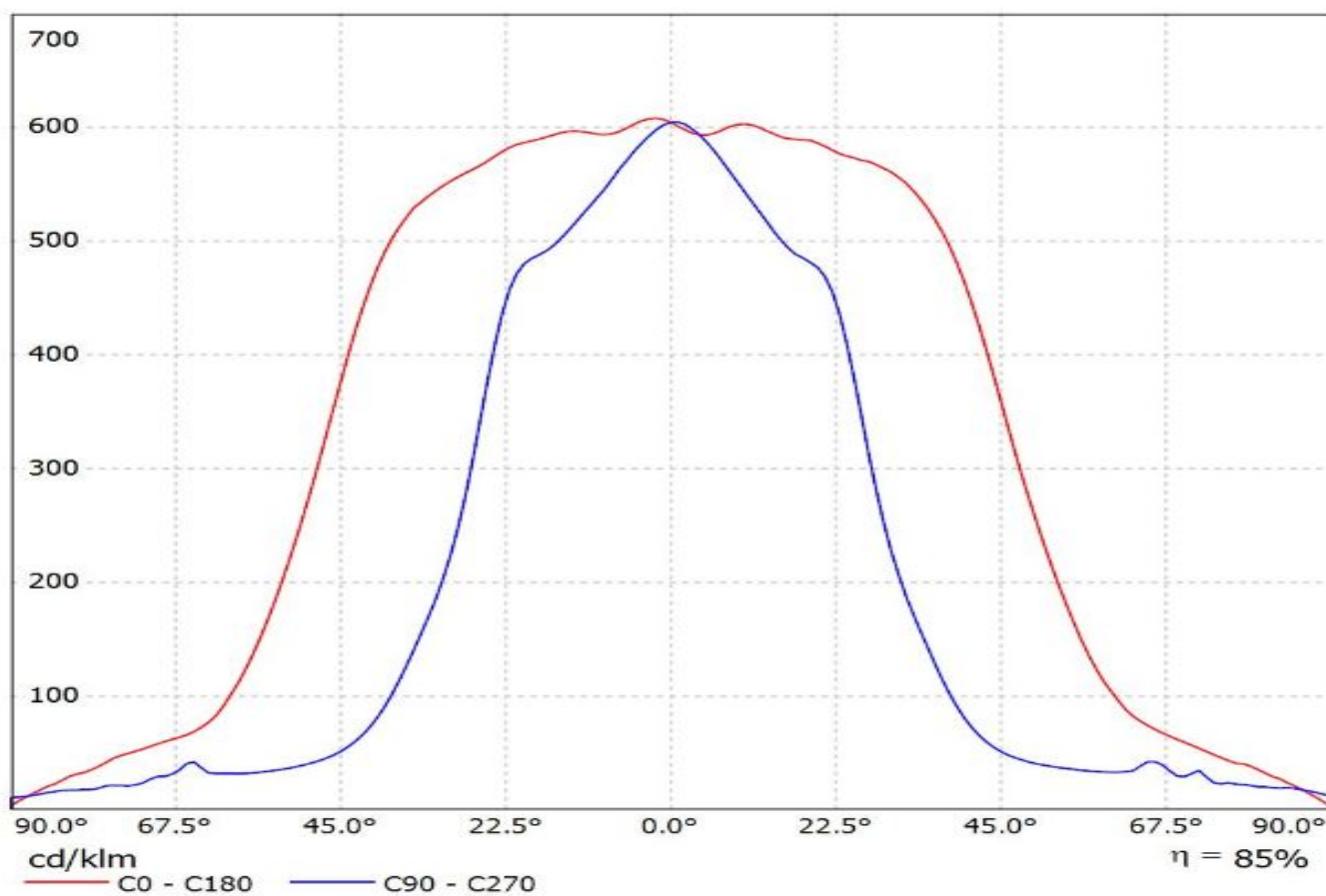

Luminaire: LEDiL Oy F15524\_LINNEA-60\_(Seoul\_semi\_5630D)  
Lamps: 1 x Seoul\_Semi\_5630D\_932.657lm@250mA\_P=5.68145W\_I=0.250A

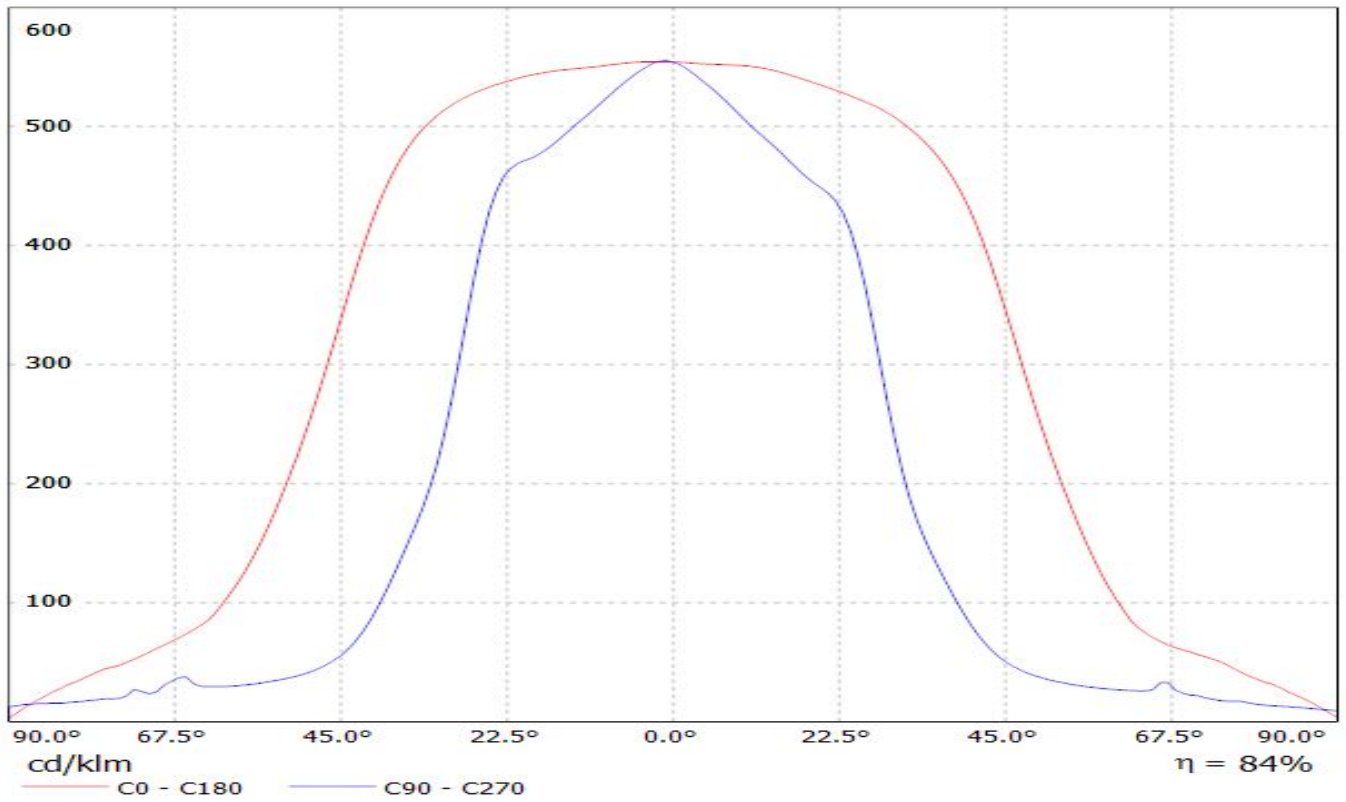

Luminaire: Ledil F15524\_LINNEA-60\_(SunLike\_3030)

Lamps: 1 x SEOUL\_SunLike\_3030\_(STW9C2PB-S)\_2\_240.649lm@0.65mA\_P=2.30531W\_U=35.538V

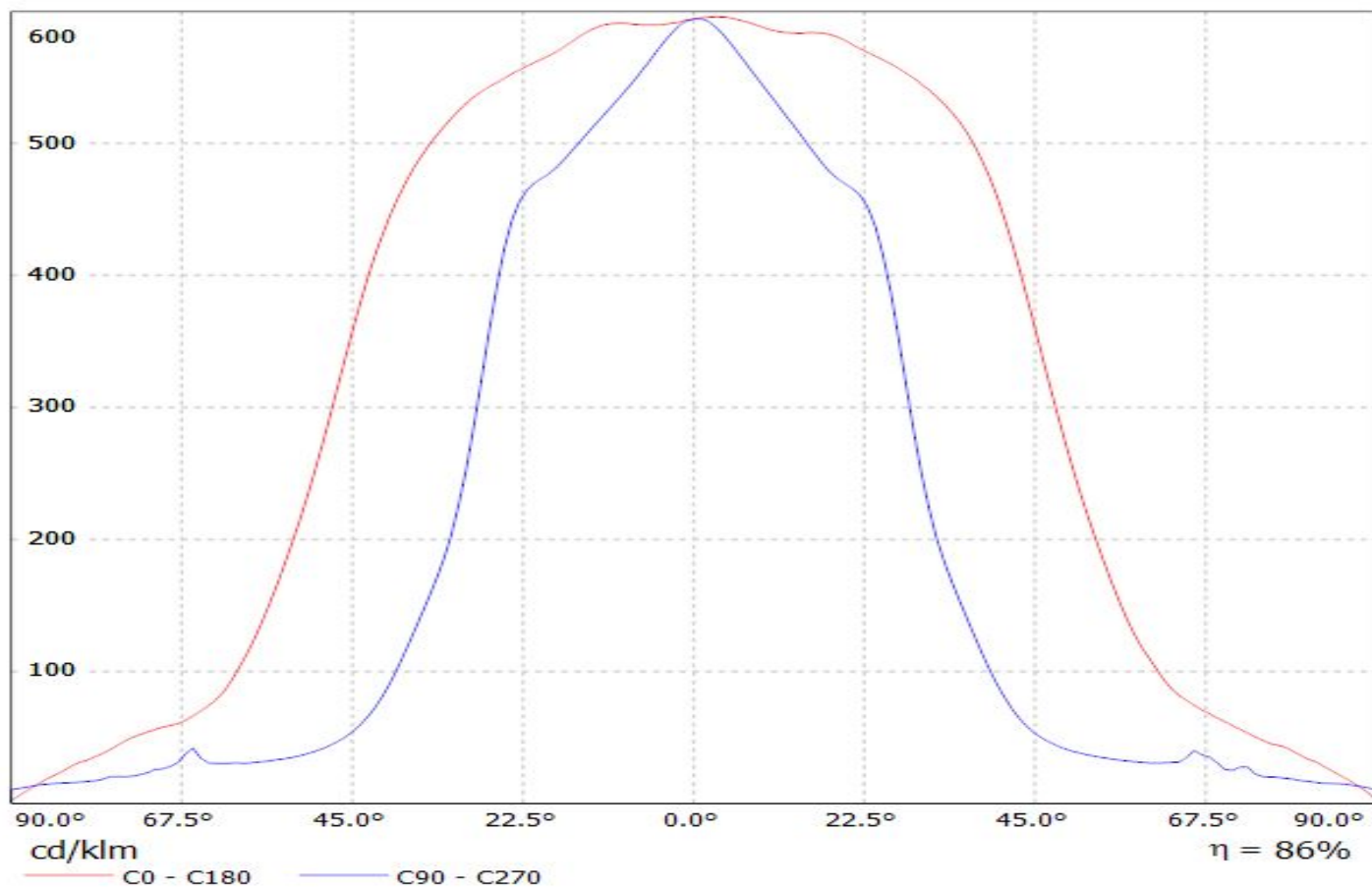

Luminaire: LEDiL Oy F15524\_LINNEA-60\_(LLE\_G4\_24x280mm\_650lm\_840\_2T\_ADV)

Lamps: 1 x

Tridonic\_LLE\_G4\_24x280mm\_650lm\_840\_2T\_ADV\_485.133lm@250mA\_CCT=4000K\_P=2.81774W\_U=11.279V

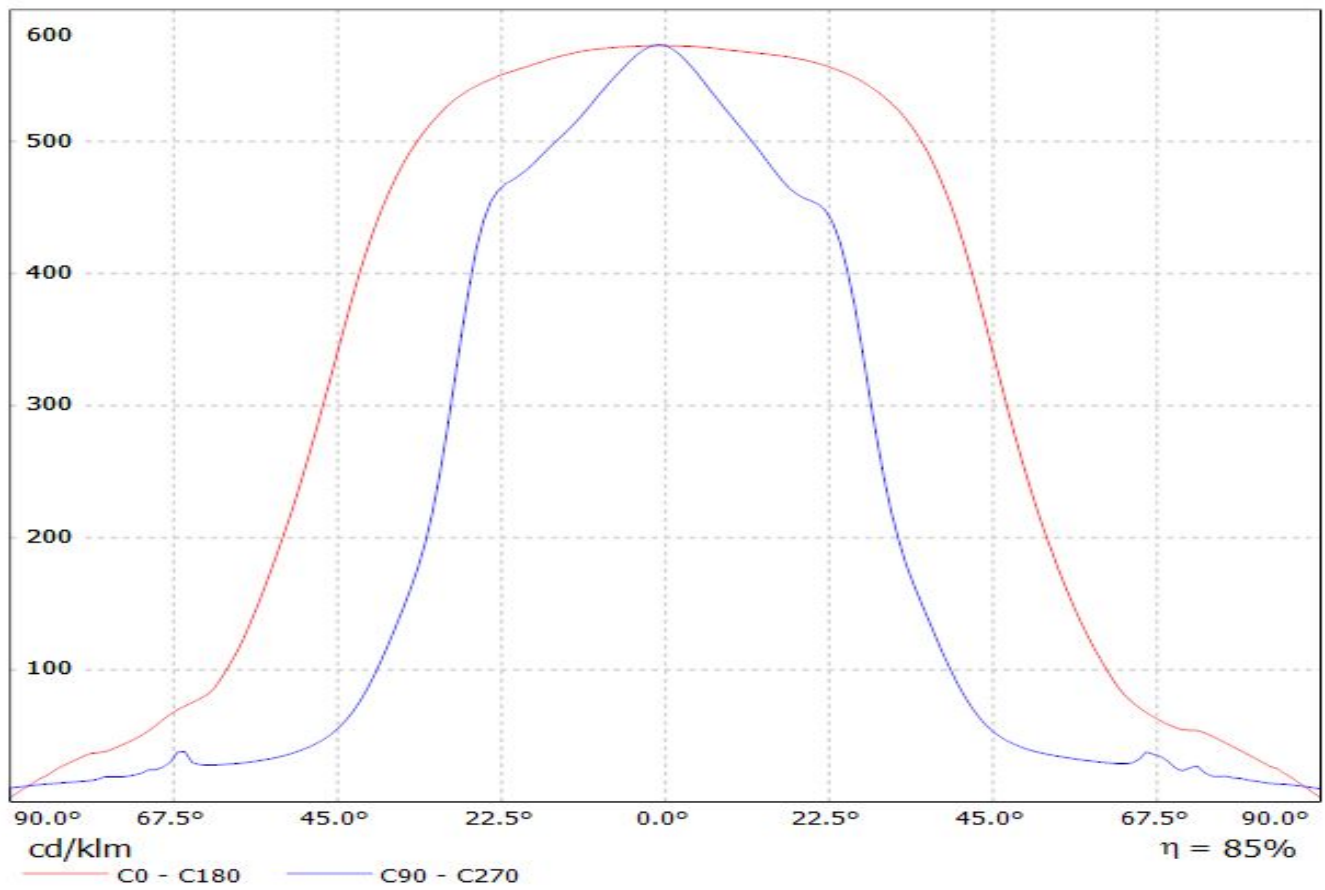

Luminaire: Ledil F15524 LINNEA-60 (LLE\_G4\_24x280mm\_1250lm\_840\_4T\_ADV)  
Lamps: 1 x Tridonic (LLE\_G4\_24x280mm\_1250lm\_840\_4T\_ADV)  
\_971.78lm@250mA\_CCT=4000K\_P=5.6355W\_U=22.5500V

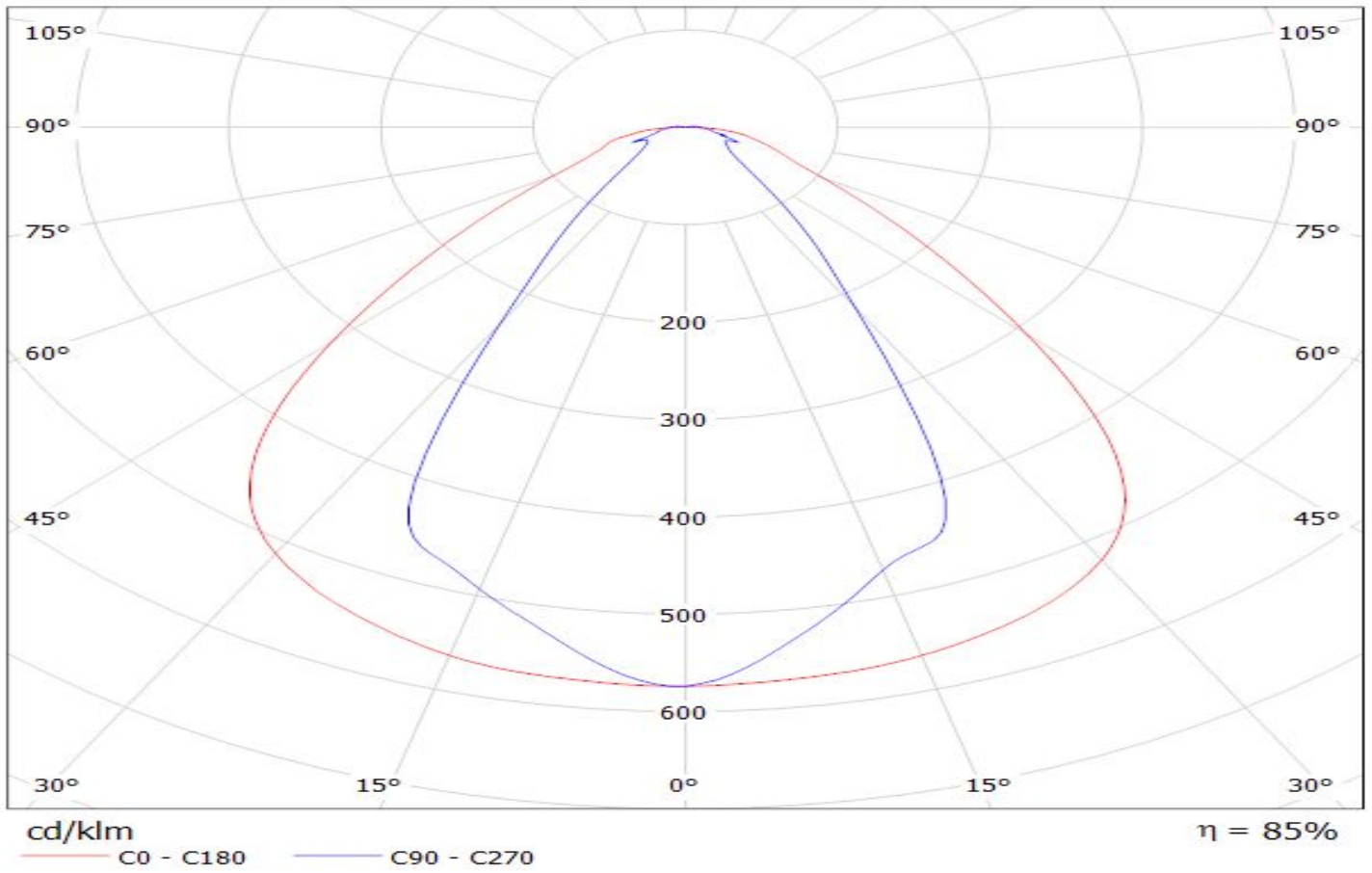

Luminaire: Ledil Oy F15524\_LINNEA-60\_(LLE G4 24x280mm 2000lm ADV)\_SIMULATED  
Lamps: 1 x Tridonic LLE G4 24x280mm 2000lm ADV

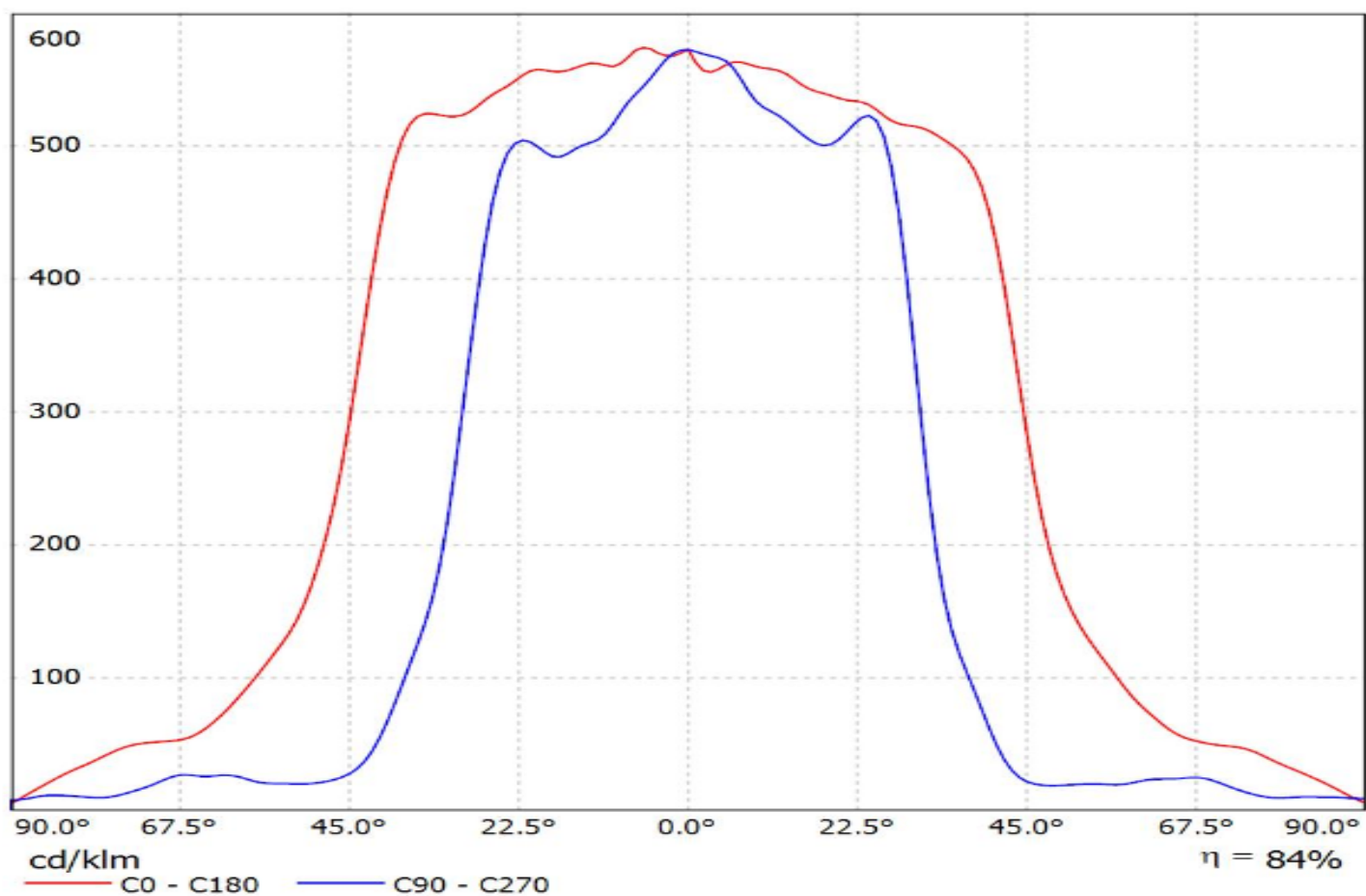

Luminaire: LEDiL Oy F15524\_LINNEA-60\_(CALOSNU405-M7W1)

Lamps: 1 x ARRANT\_LIGHT\_CALOSNU405-M7W1\_494.124lm@250mA\_CCT=4000K\_P=2.74955W\_U=11.007V

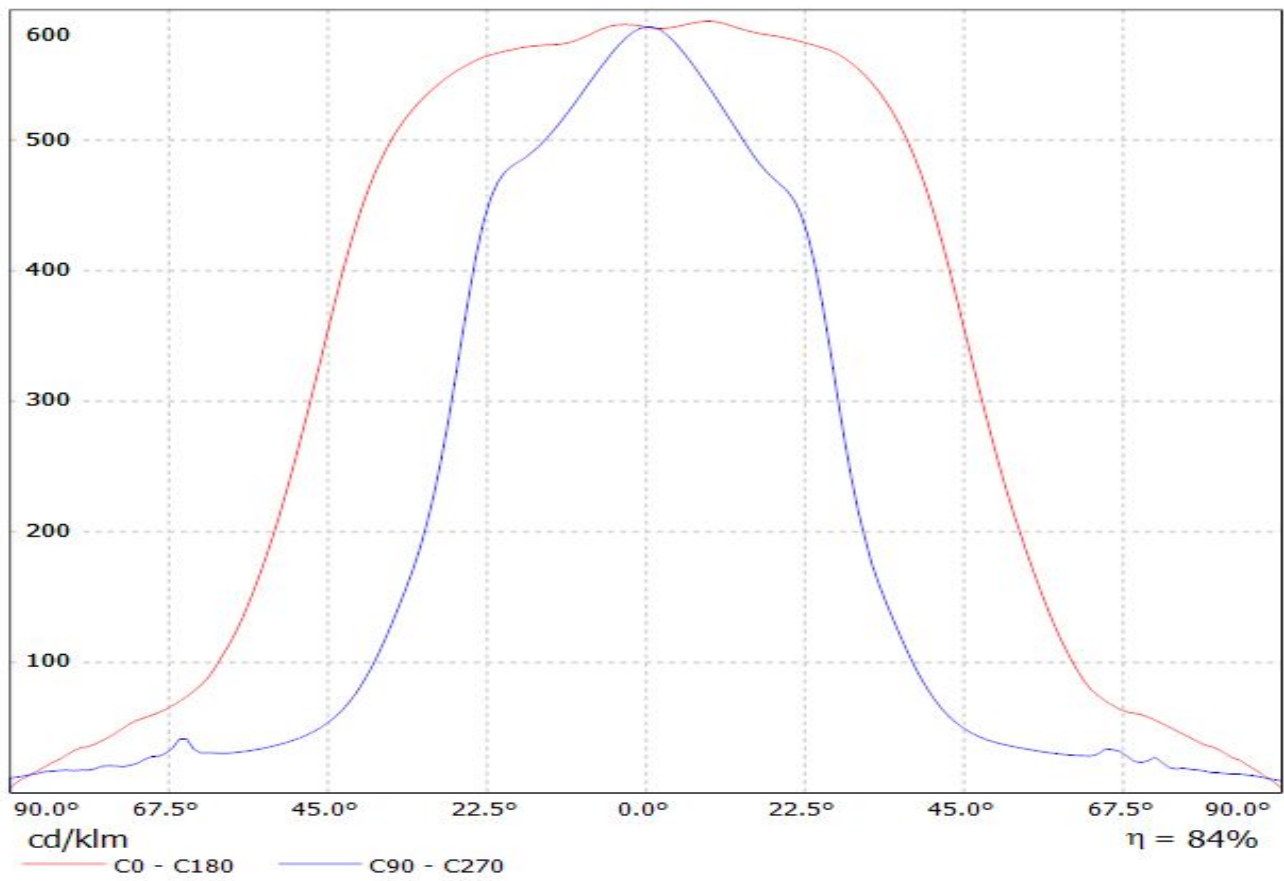

Luminaire: Ledil F15524\_LINNEA-60\_(CALOSNU410-M7W1)

Lamps: 1 x ARRANT\_LIGHT\_CALOSNU410-M7W1\_499.378lm@250mA\_CCT=4000K\_P=2.70242W\_U=10.814V

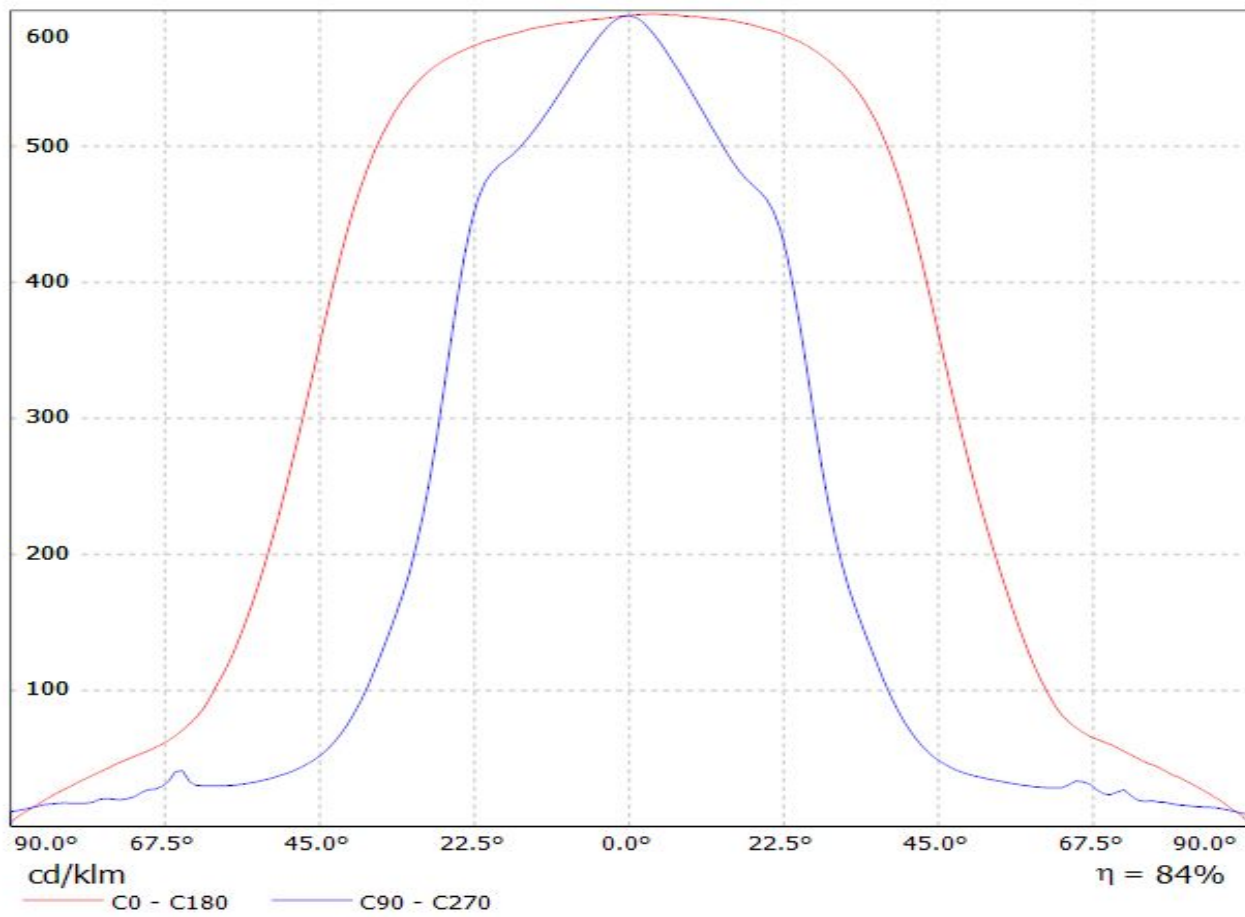

Luminaire: Ledil F15524\_LINNEA-60\_(Tridino\_1ft\_1100lm\_840HE\_1R\_HV)

Lamps: 1 x Tridino\_1ft\_1100lm\_840HE\_1R\_HV\_(Edison2835HE)\_1343.19lm@250mA\_P=8.02229W\_I=0.250A

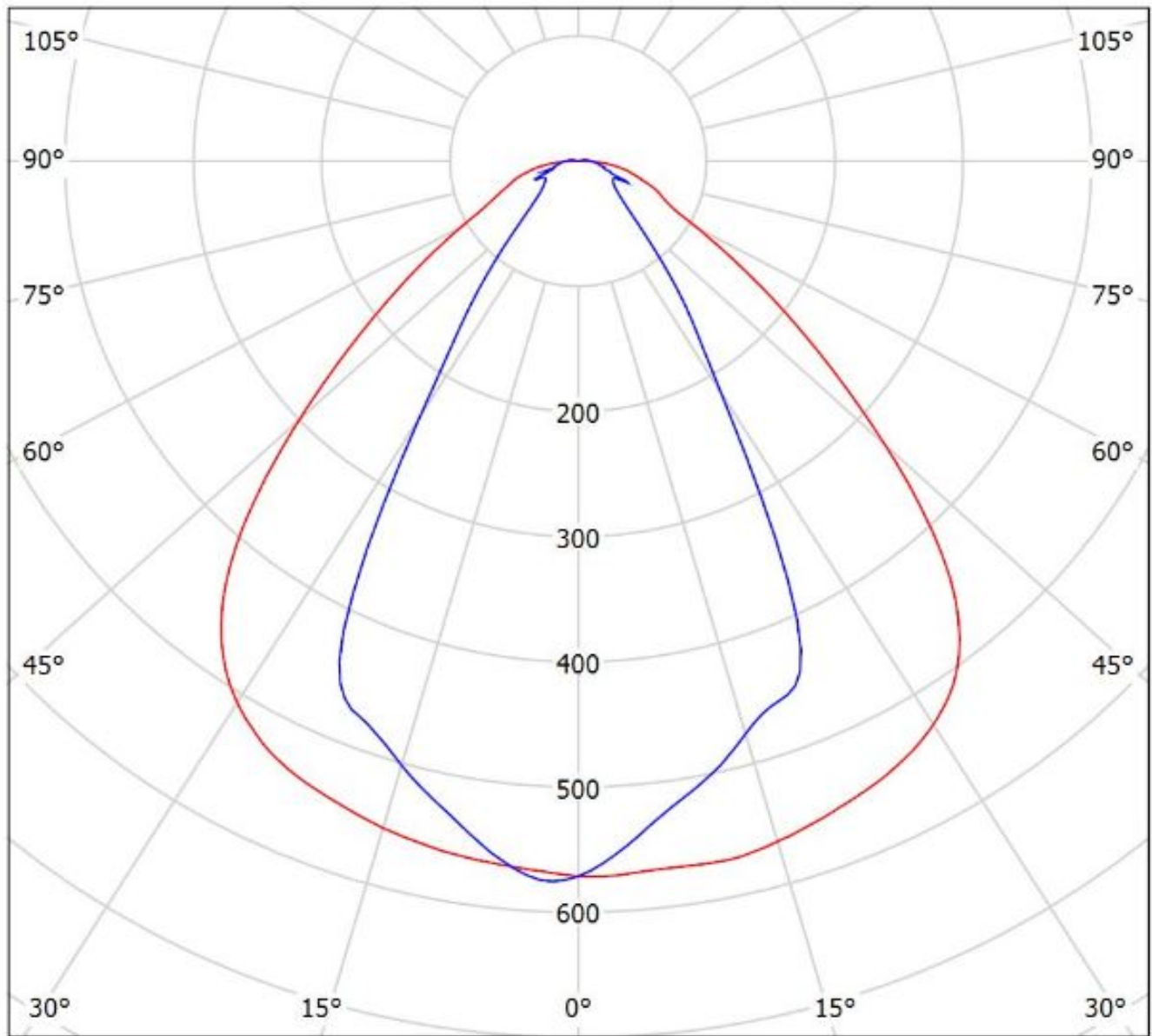

cd/klm

— C0 - C180 — C90 - C270

$\eta = 86\%$

Luminaire: LEDiL Oy F15524\_LINNEA-60\_(XP-E)

Lamps: 1 x Cree\_XP-E\_x12\_(XPEWHT-L1-3C0-Q5-0-00)\_920.665lm@250mA\_P=9.07548W\_U=36.329V

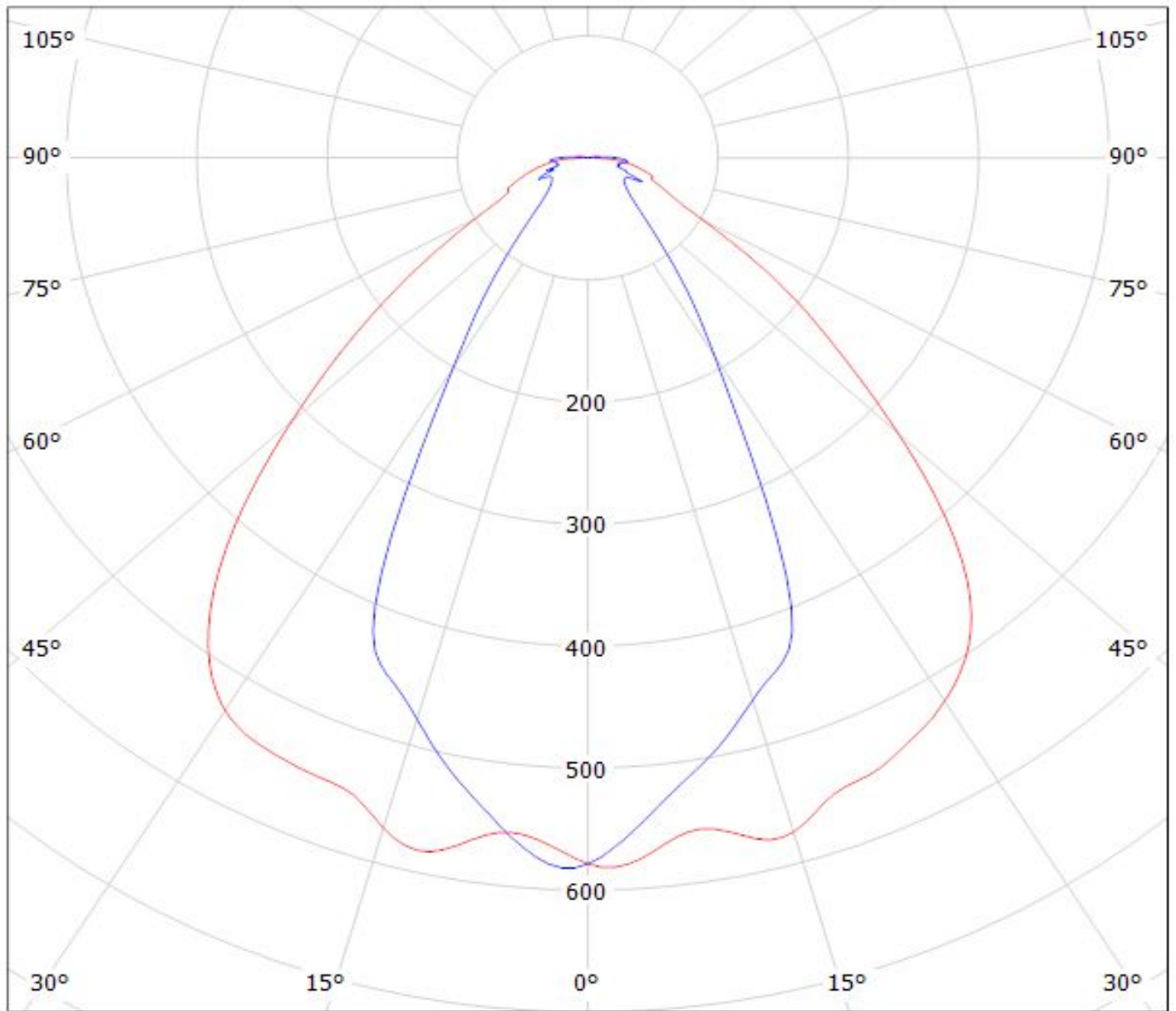

cd/klm

— C0 - C180 — C90 - C270

$\eta = 83\%$

Luminaire: Ledil Oy F15524\_LINNEA-60\_(NF2W757GR-V1)\_SIMULATED

Lamps: 1 x Nichia NF2W757GR-V1

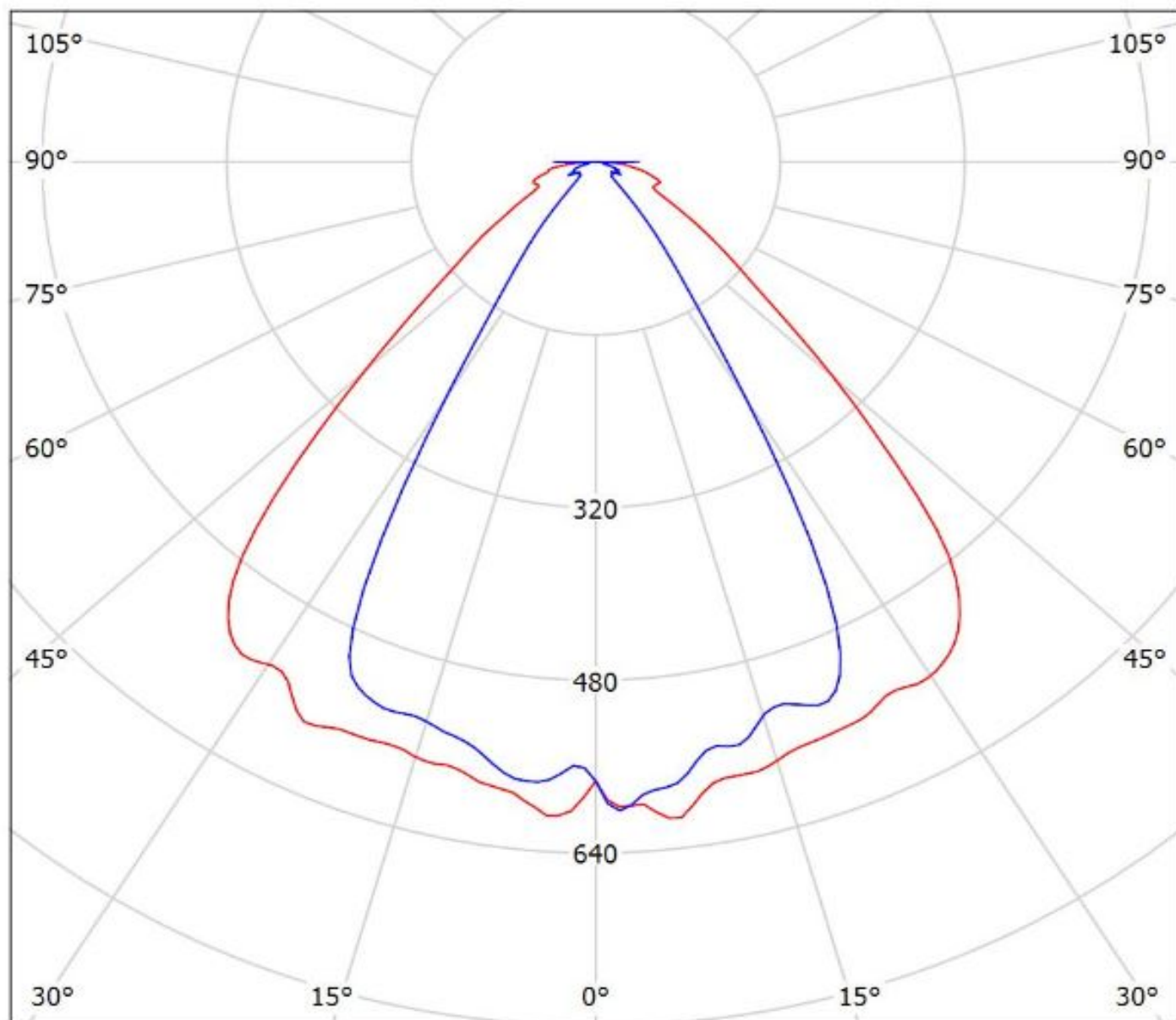

$\eta = 85\%$

cd/klm

— C0 - C180 — C90 - C270

Luminaire: LEDiL Oy F15524\_LINNEA-60\_(NFSx757G)

Lamps: 1 x Nichia\_NFSx757Gx12\_389.068lm@65mA\_P=2.23905W\_U=34.391V

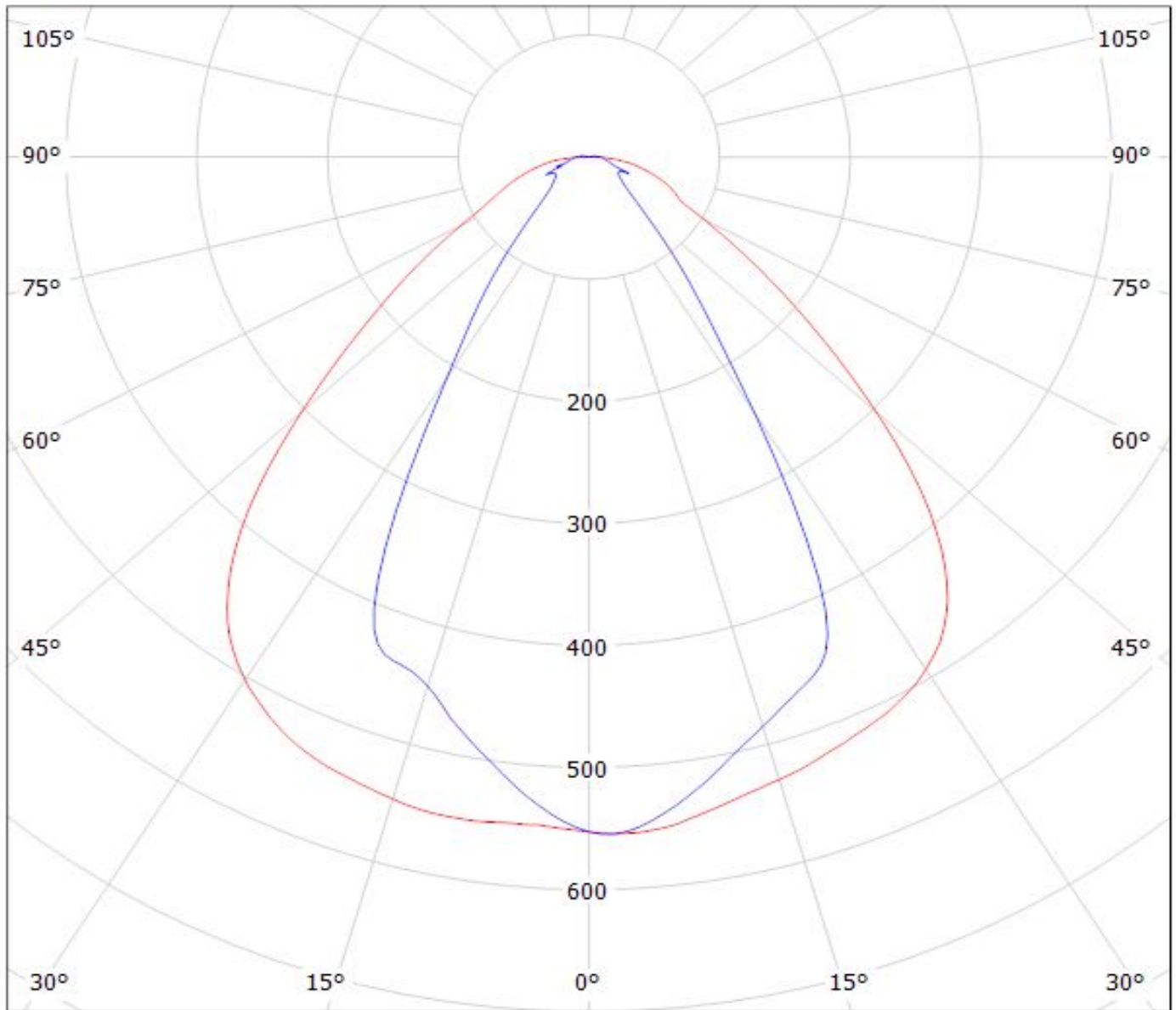

cd/klm

— C0 - C180    — C90 - C270

$\eta = 83\%$

Luminaire: LEDiL Oy F15524\_LINNEA-60\_(Prevaled\_Linear\_Slim\_1100lm)

Lamps: 1 x Osram\_Prevaled\_Linear\_Slim\_1100lm\_(PL-LIN\_S-Z3\_1100-830\_280)\_1027.96lm@170mA\_CCT=3000K\_P=6.43142W\_I=0.250A

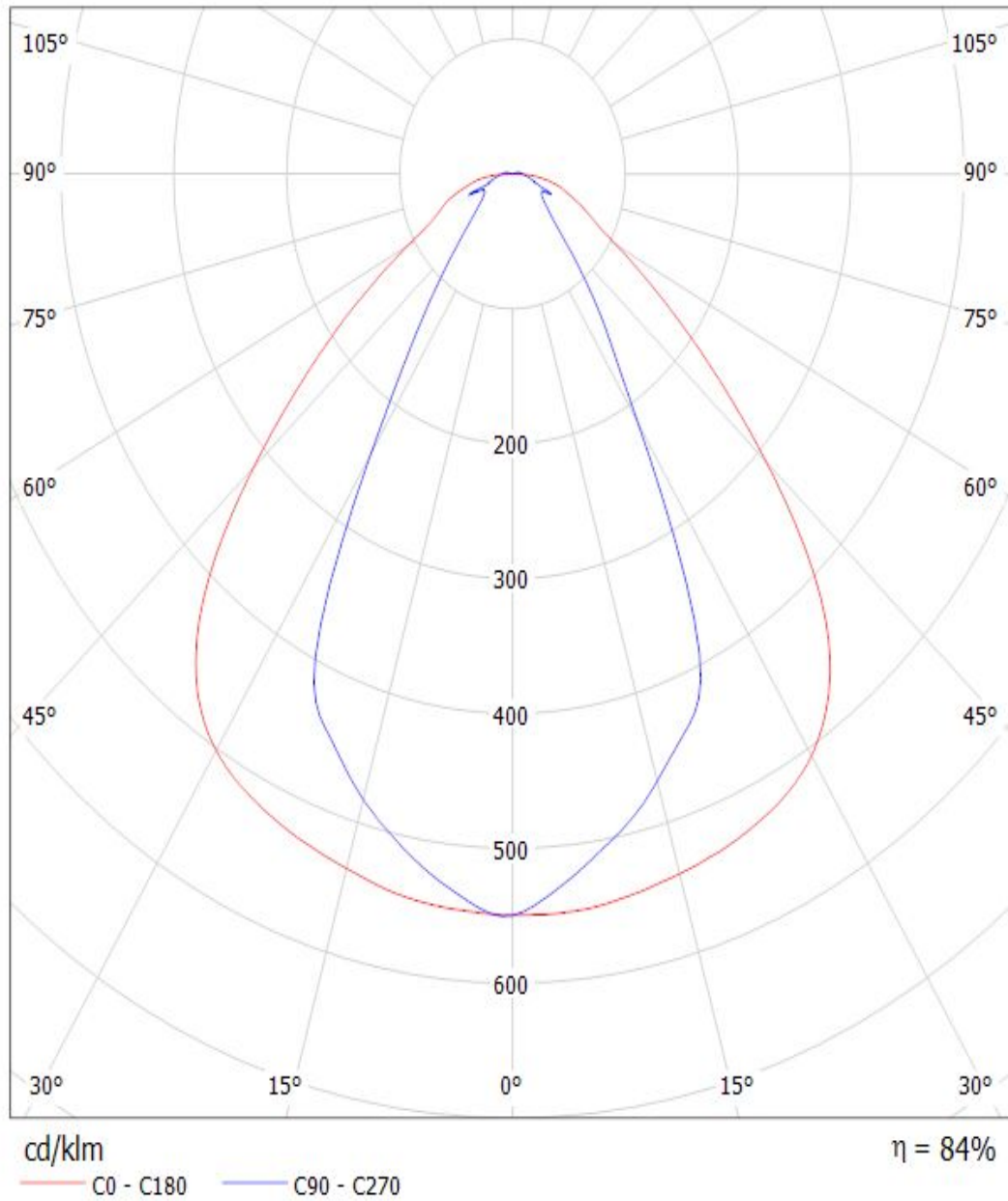

Luminaire: Ledil F15524\_LINNEA-60\_(Prevaled\_Linear\_Slim\_3)  
Lamps: 1 x Osram\_Prevaled\_Linear\_Slim\_3\_(PL-LIN S-Z3-2000-840-280)  
\_1949.14lm@300mA\_CCT=4000K\_P=12.0015W\_U=40.179V

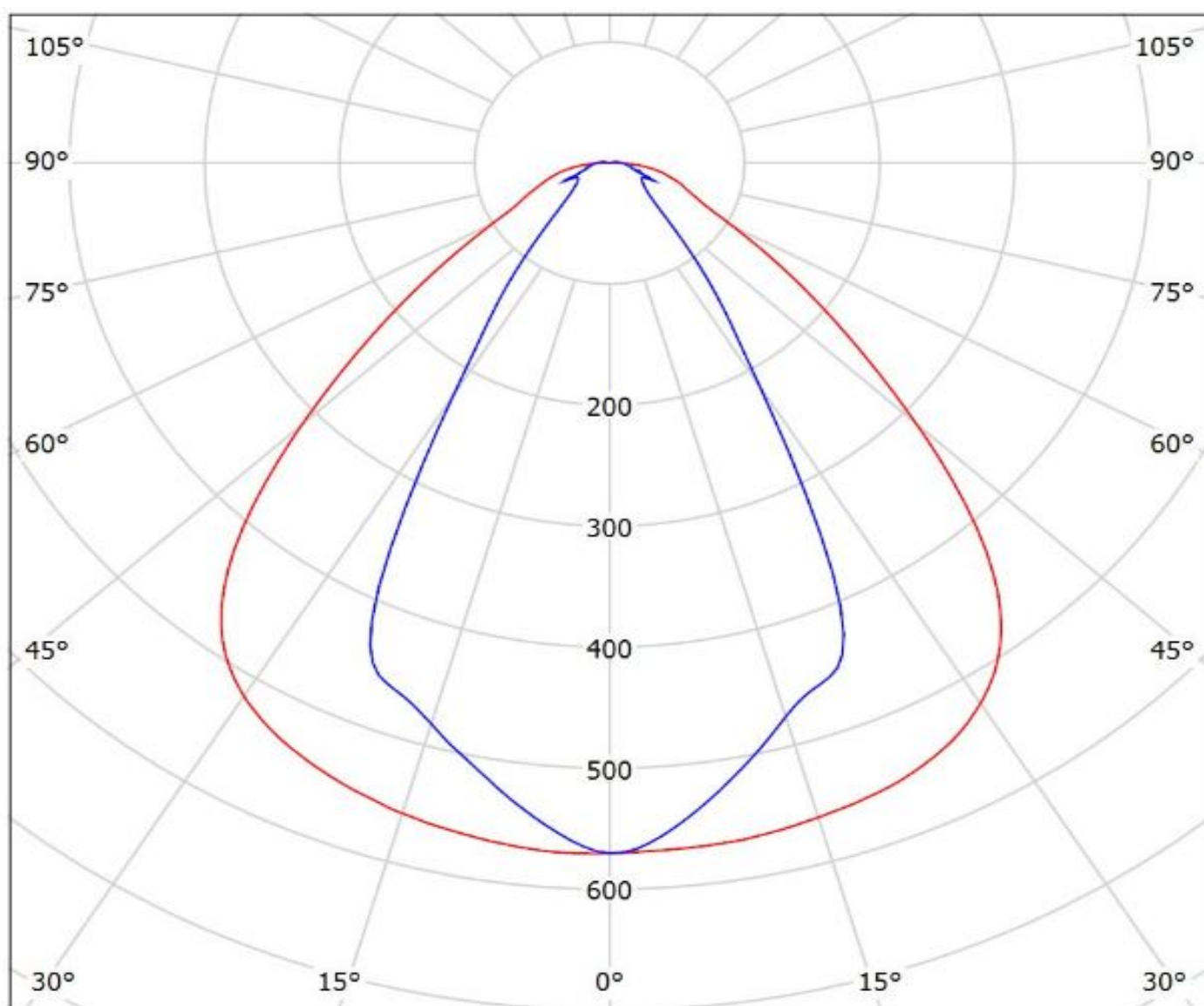

cd/klm  
— C0 - C180 — C90 - C270

$\eta = 84\%$

Luminaire: Ledil F15524\_LINNEA-60\_(Duris\_S5)

Lamps: 1 x Osram\_Duris\_S5\_1183.73lm@250mA\_P=8.66003W\_U=34.724V

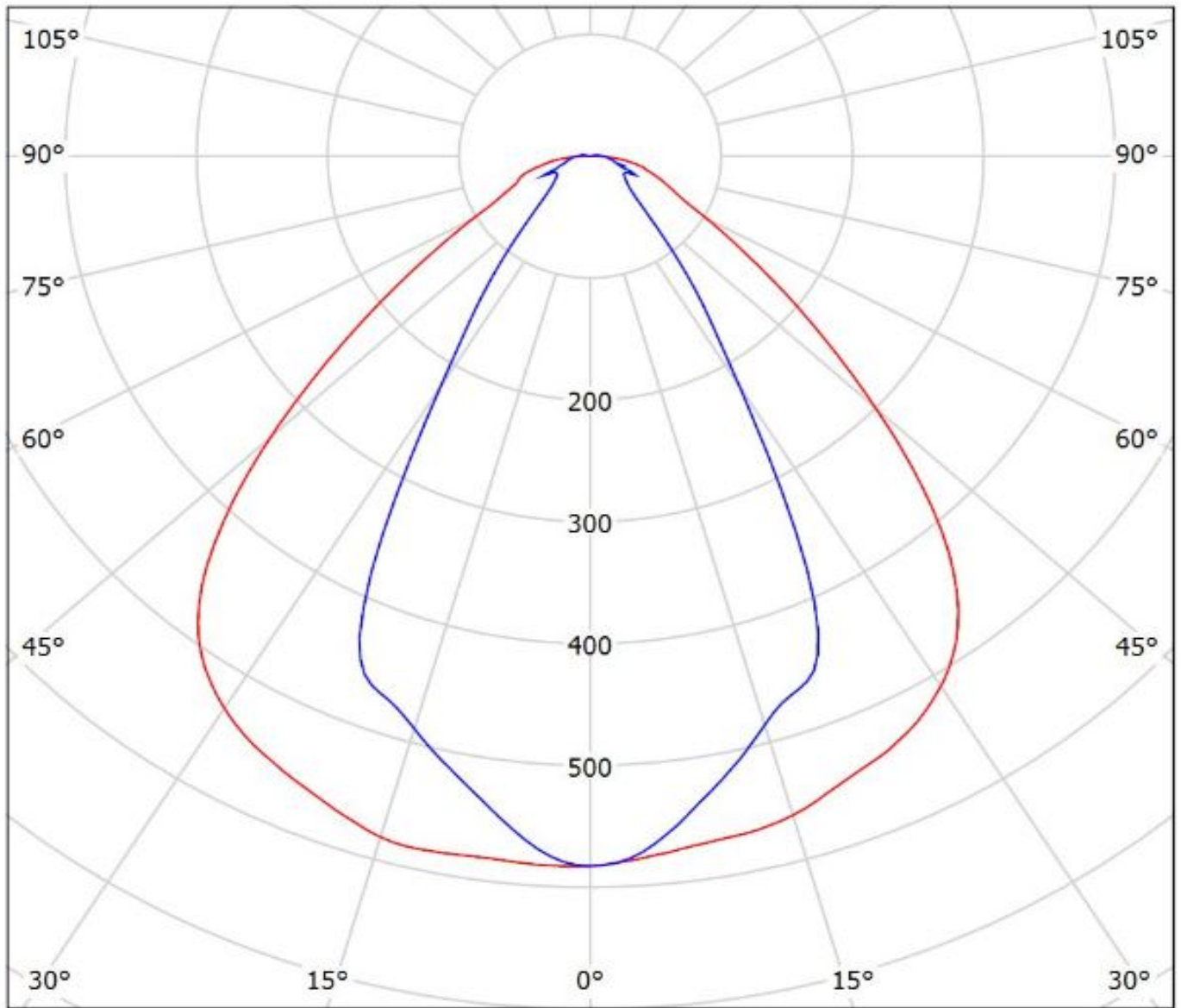

cd/klm

— C0 - C180

— C90 - C270

$\eta = 85\%$

Luminaire: LEDiL Oy F15524\_LINNEA-60\_(Duris\_S5\_1chip)  
Lamps: 1 x Osram\_Duris\_S5\_1chip\_(GWPSLM31\_EM-GUHQ-A535-1)  
\_359.255lm@65mA\_P=2.13817W\_U=33.253V

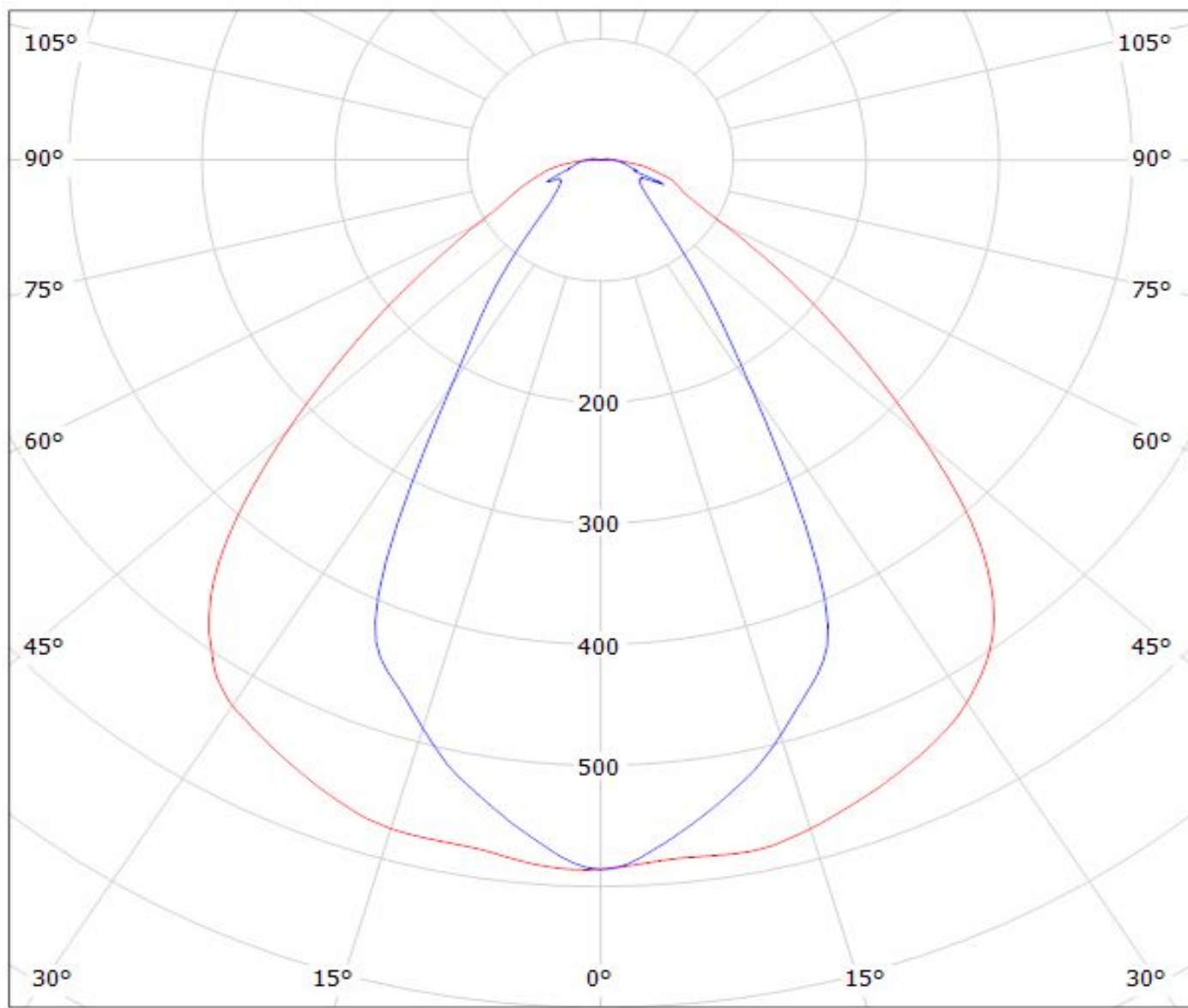

cd/klm

— C0 - C180    — C90 - C270

$\eta = 86\%$

Luminaire: Ledil F15524\_LINNEA-60\_(Fortimo\_LED\_Strip\_1ft\_1100lm\_FC\_HV4)  
Lamps: 1 x Philips\_Fortimo\_LED\_Strip\_1ft\_1100lm\_930\_FC\_HV4\_735.772lm@250mA\_P=5.6145W\_U=22.496V

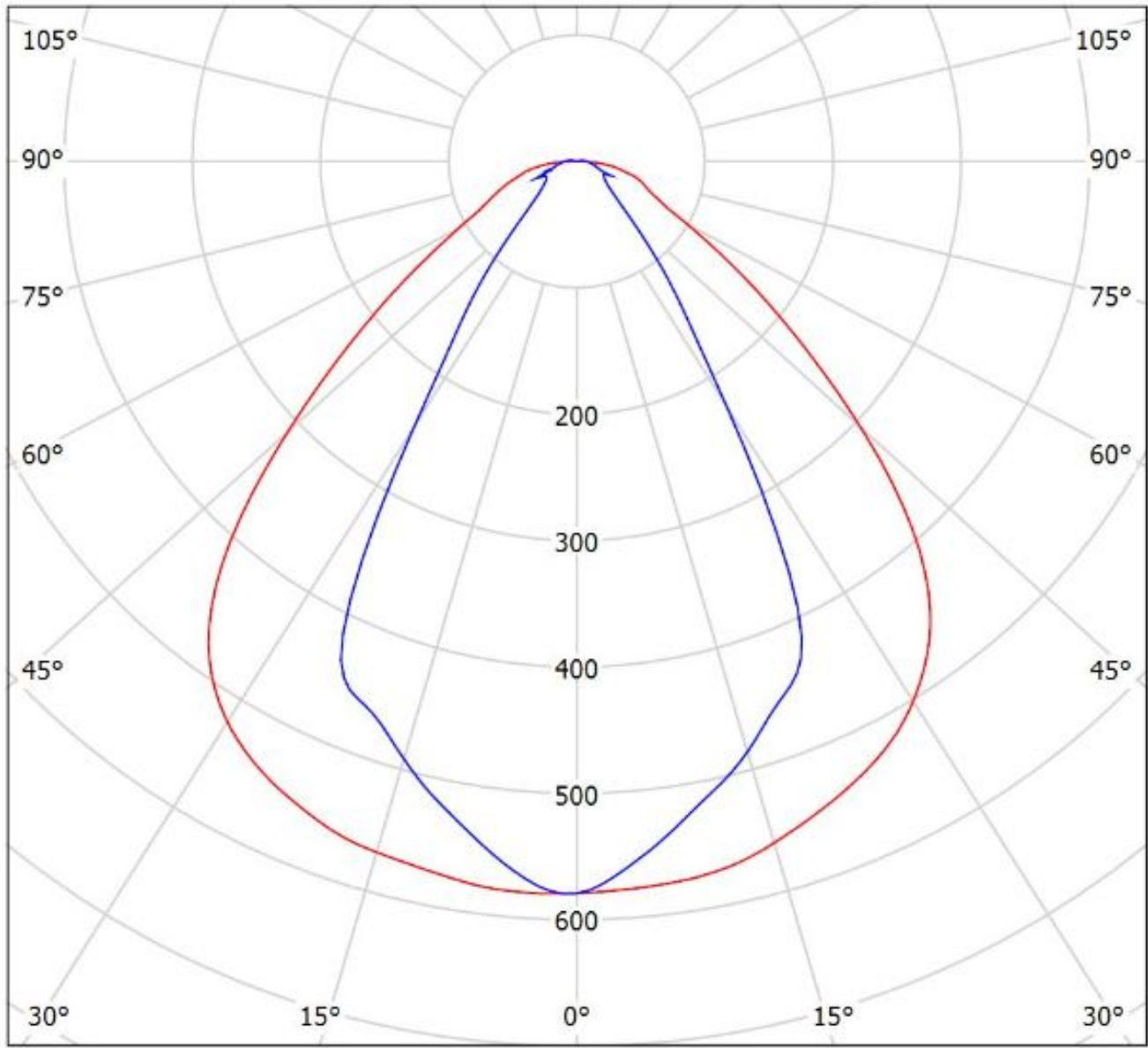

cd/klm

— C0 - C180 — C90 - C270

$\eta = 85\%$

Luminaire: Ledil F15524\_LINNEA-60\_(Fortimo\_LED\_Strip\_1ft\_650lm\_FC\_LV4)

Lamps: 1 x Philips\_Fortimo\_LED\_Strip\_1ft\_650lm\_FC\_LV4\_994.849lm@190mA\_P=6.82273W\_U=35.990V

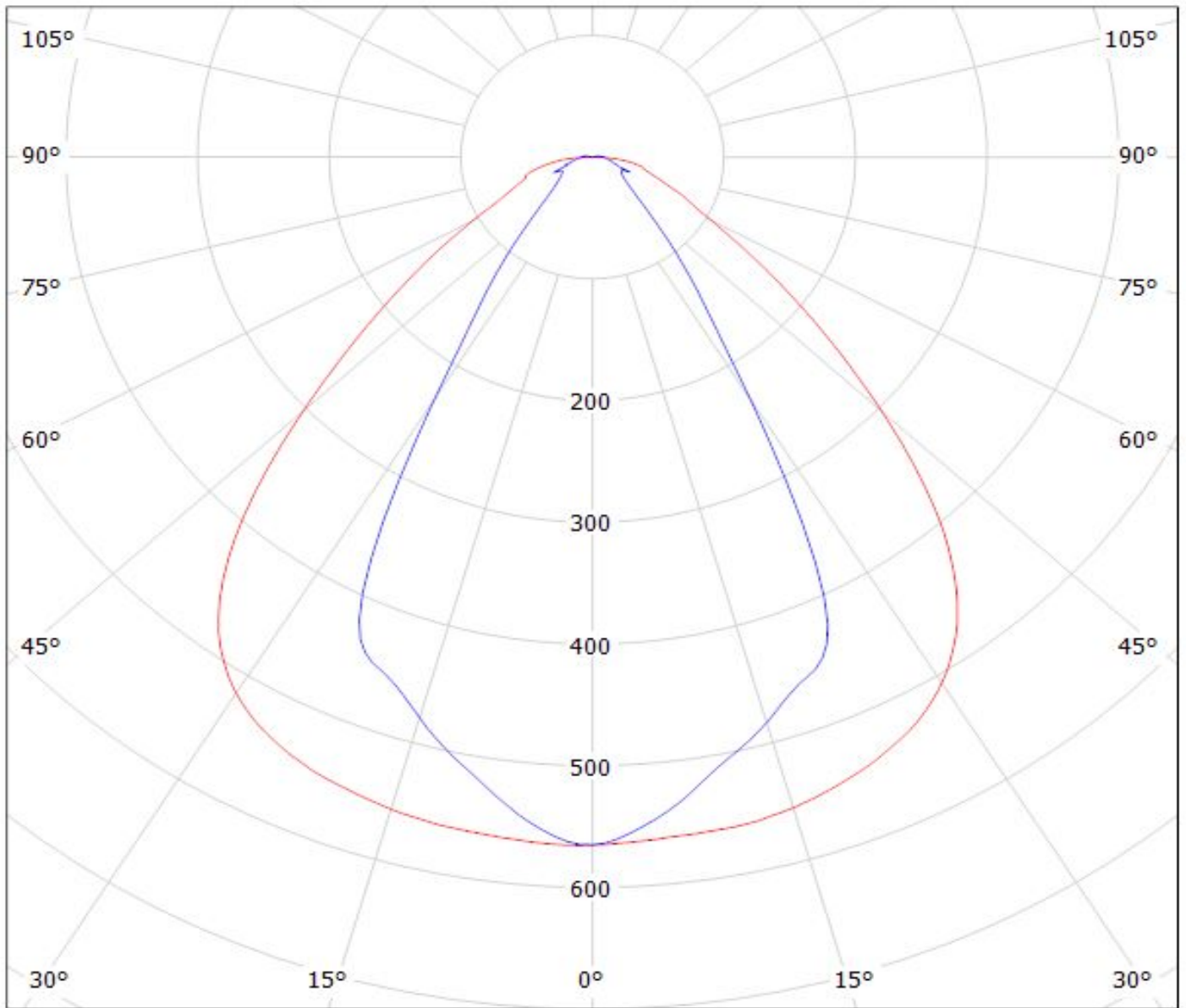

cd/klm

— C0 - C180

— C90 - C270

$\eta = 84\%$

Luminaire: LEDiL Oy F15524\_LINNEA-60\_(LM561B+)\_Cav1

Lamps: 1 x Samsung\_LM561B+\_1370.33lm@250mA\_P=9.1162W\_I=0.250A

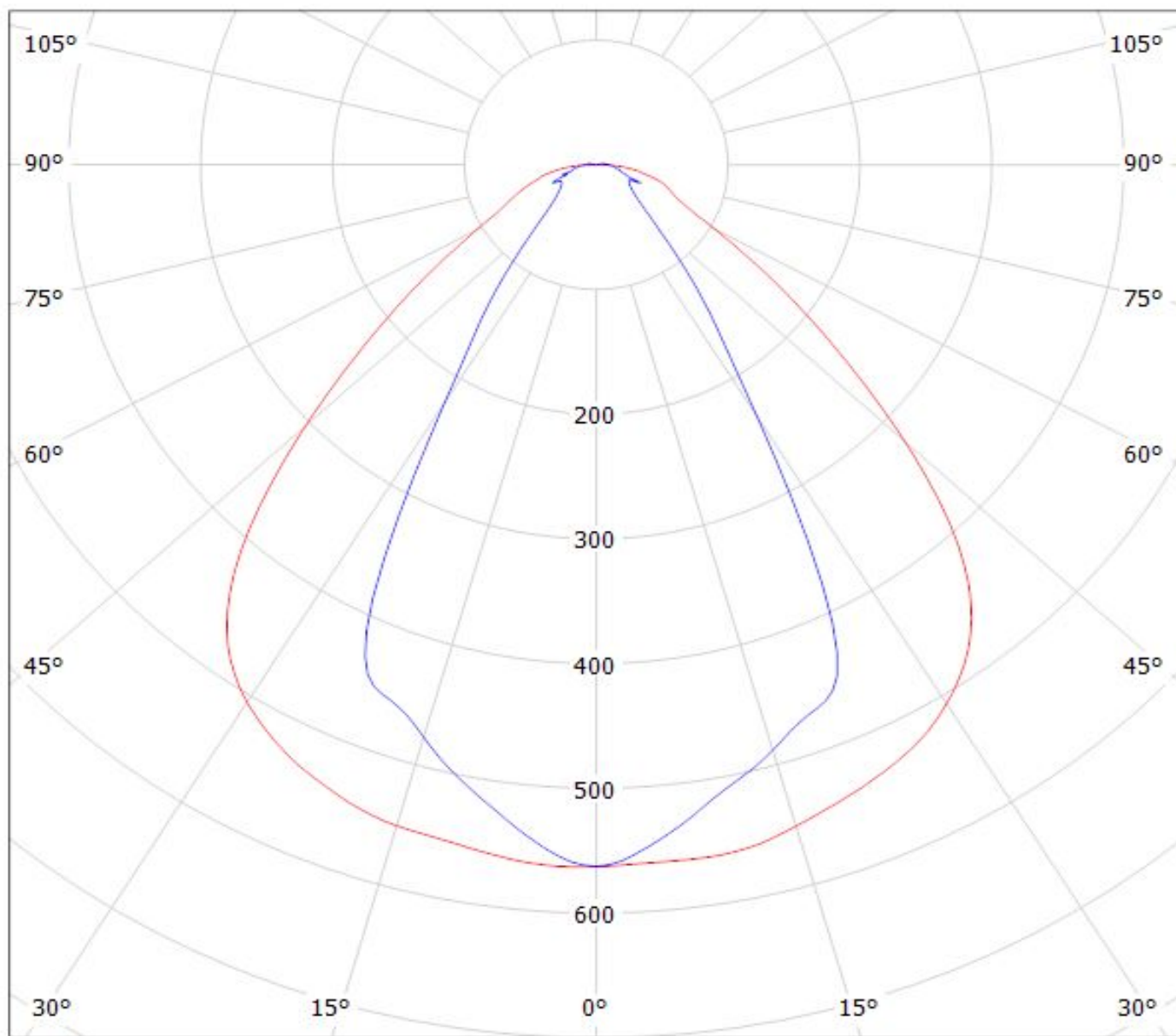

cd/klm

— C0 - C180

— C90 - C270

$\eta = 85\%$

Luminaire: Ledil F15524\_LINNEA-60\_(LT-V282E)

Lamps: 1 x Samsung\_LT-V282E\_(LM281B)\_1072.13lm@300mA\_CCT=4000K\_P=7.1427W\_I=0.30A

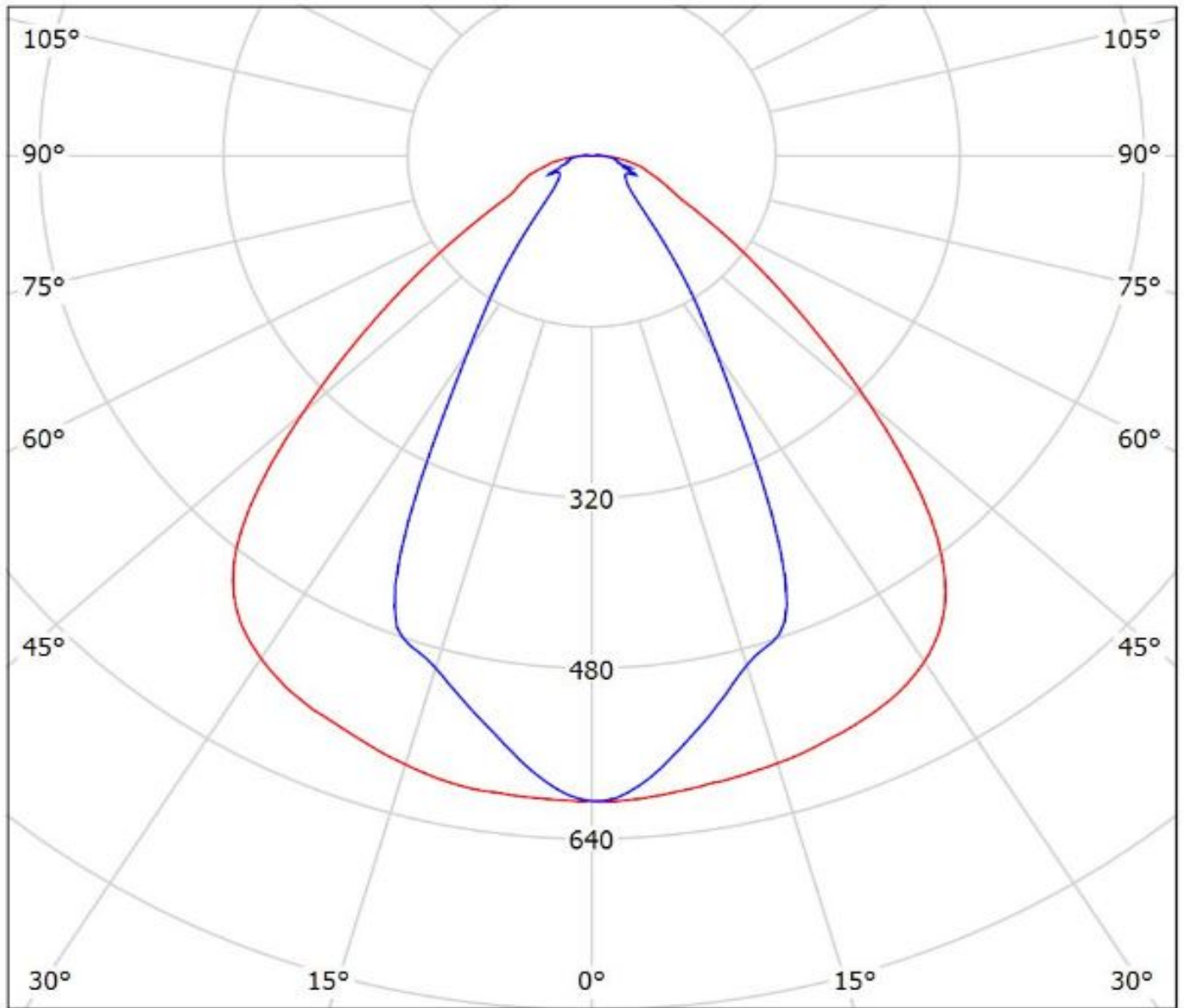

cd/klm

— C0 - C180 — C90 - C270

$\eta = 86\%$

Luminaire: Ledil F15524\_LINNEA-60\_(LT-V562E)

Lamps: 1 x Samsung\_LT-V562E\_(LM281B)\_2144.6lm@300mA\_CCT=4000K\_P=14.2854W\_I=0.30A

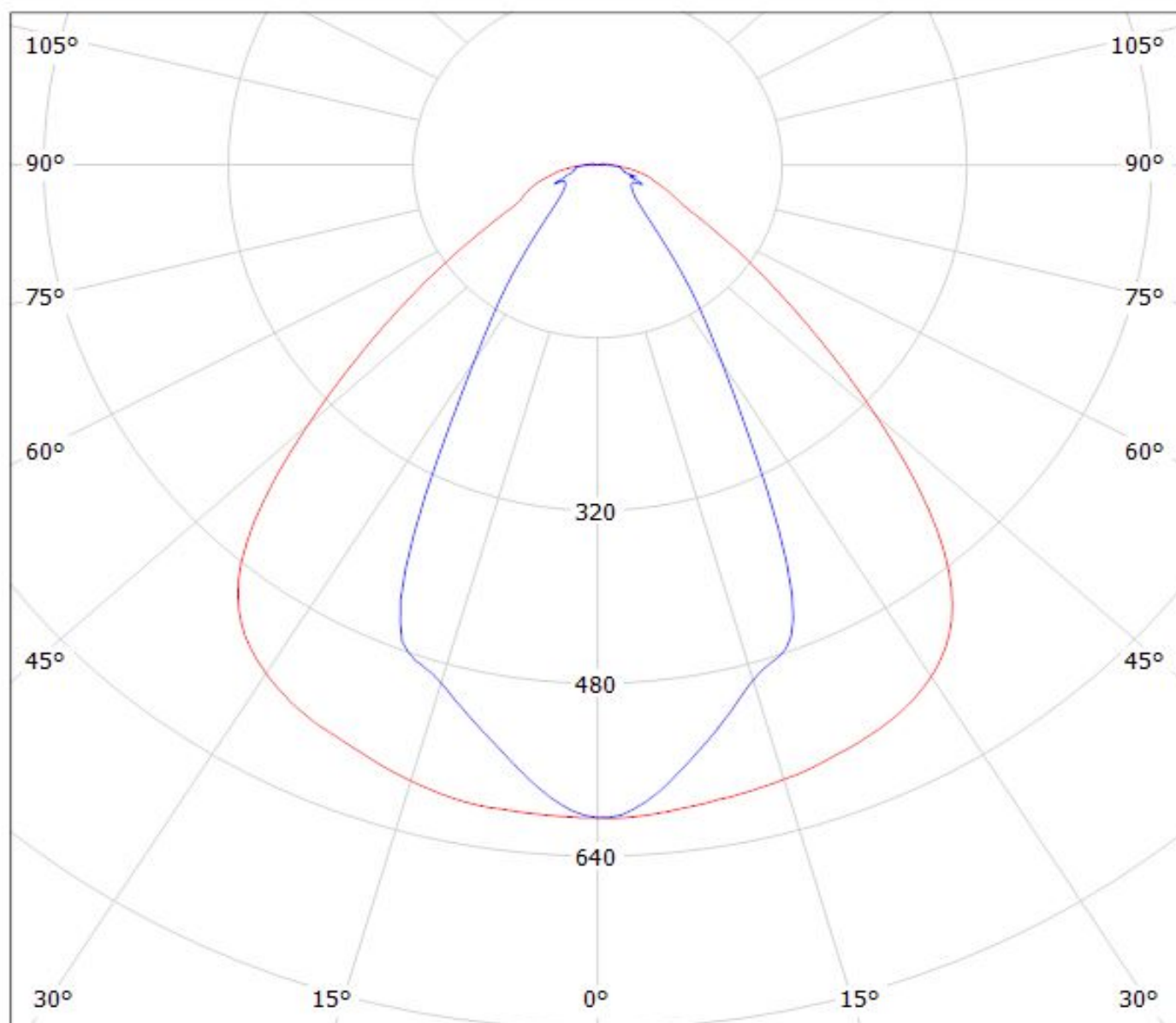

cd/klm

— C0 - C180

— C90 - C270

$\eta = 85\%$

Luminaire: Ledil F15524 LINNEA-60\_(LT-H282C)

Lamps: 1 x Samsung\_LT-H282C\_(LM561C)\_997.05lm@240mA\_CCT=4000K\_P=5.43445W\_I=0.240A

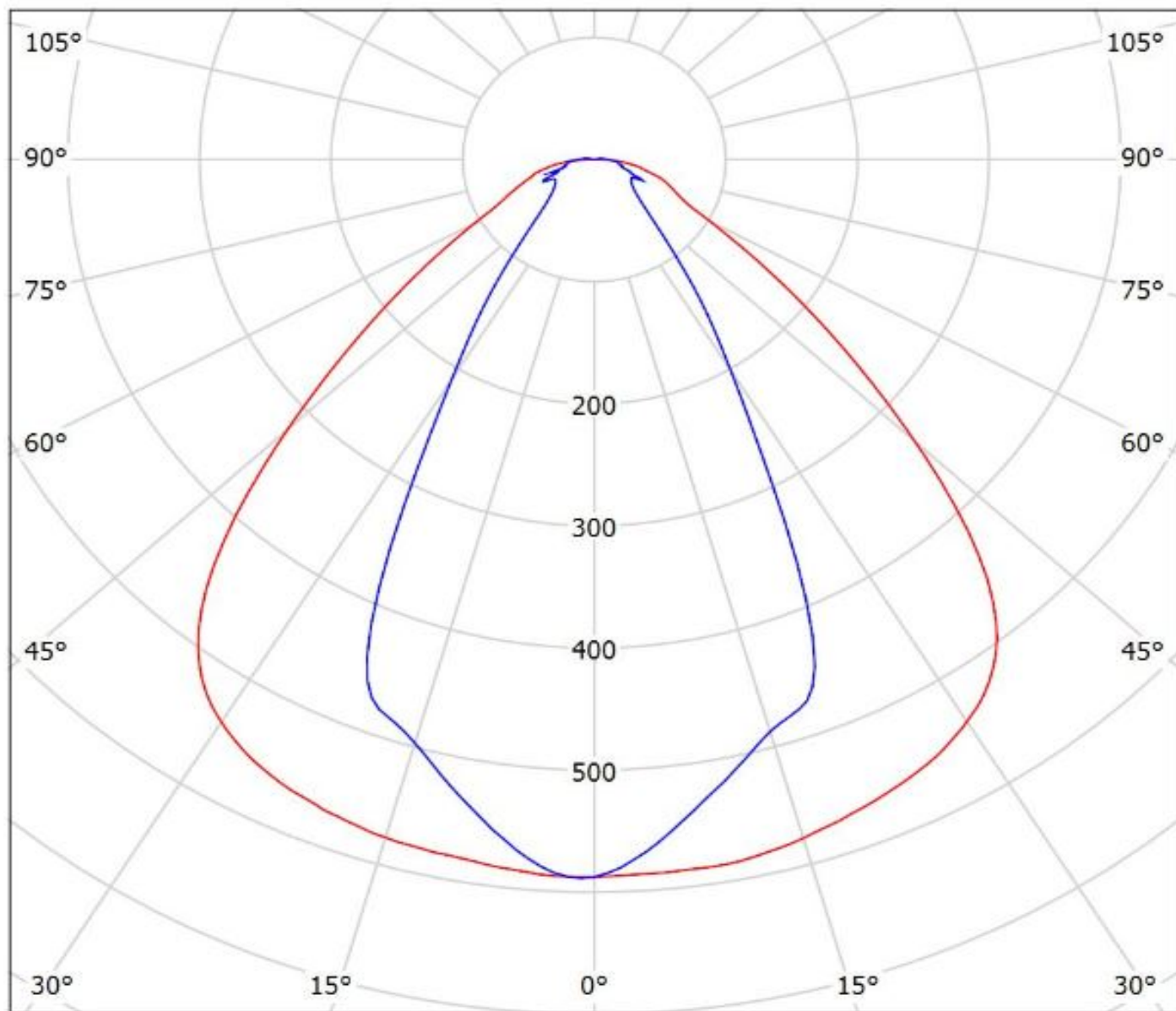

cd/klm

— C0 - C180    — C90 - C270

$\eta = 85\%$

Luminaire: Ledil F15524\_LINNEA-60\_(LT-H562C)

Lamps: 1 x Samsung\_LT-H562C\_(LM561C)\_1994.1lm@240mA\_CCT=4000K\_P=10.8689W\_I=0.240A

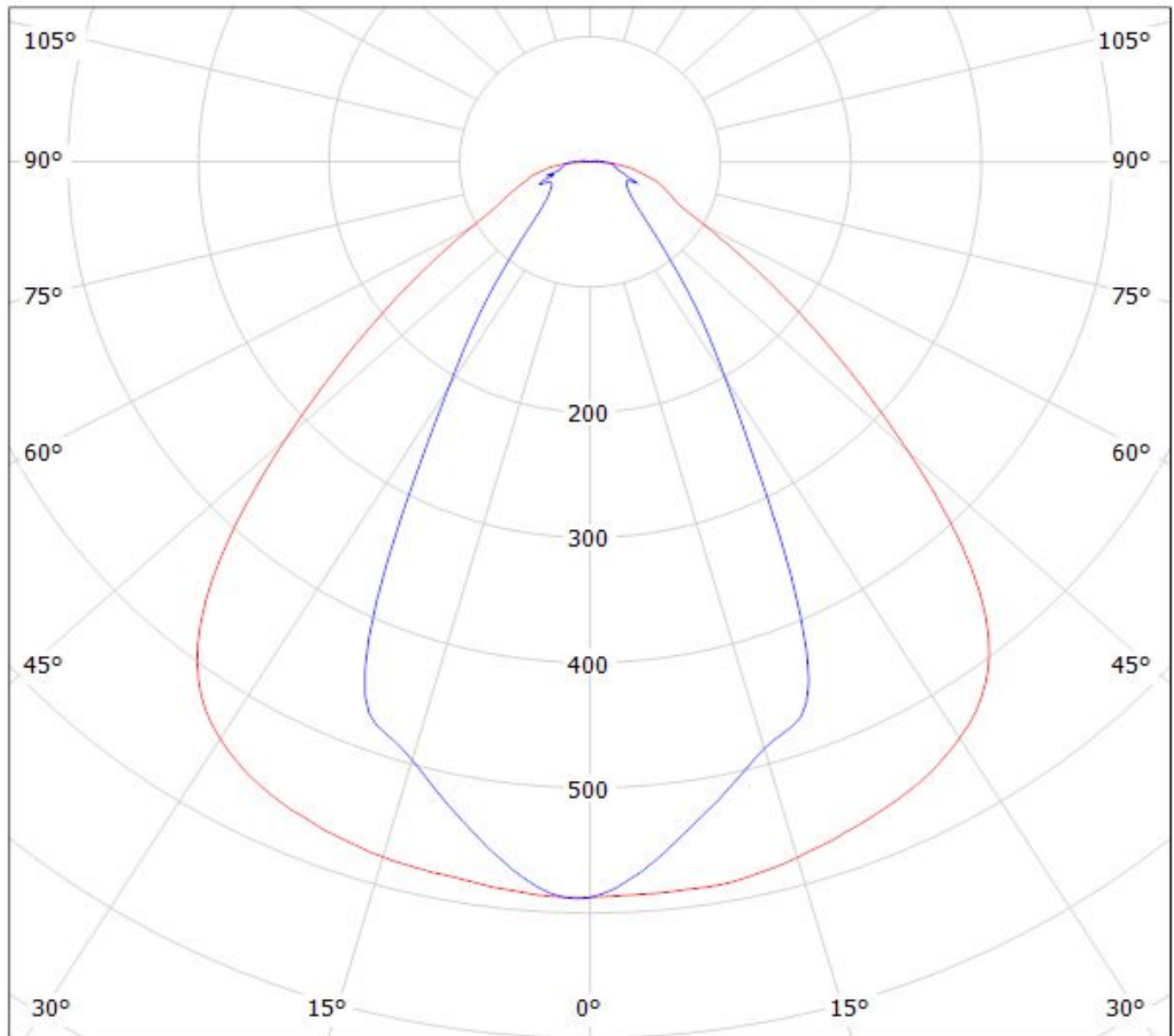

cd/klm

— C0 - C180

— C90 - C270

$\eta = 85\%$

Luminaire: Ledil F15524\_LINNEA-60\_(LT-S282H)

Lamps: 1 x Samsung\_LT-S282H\_(LM561B+)\_1143.31lm@300mA\_P=7.2W\_I=0.30A

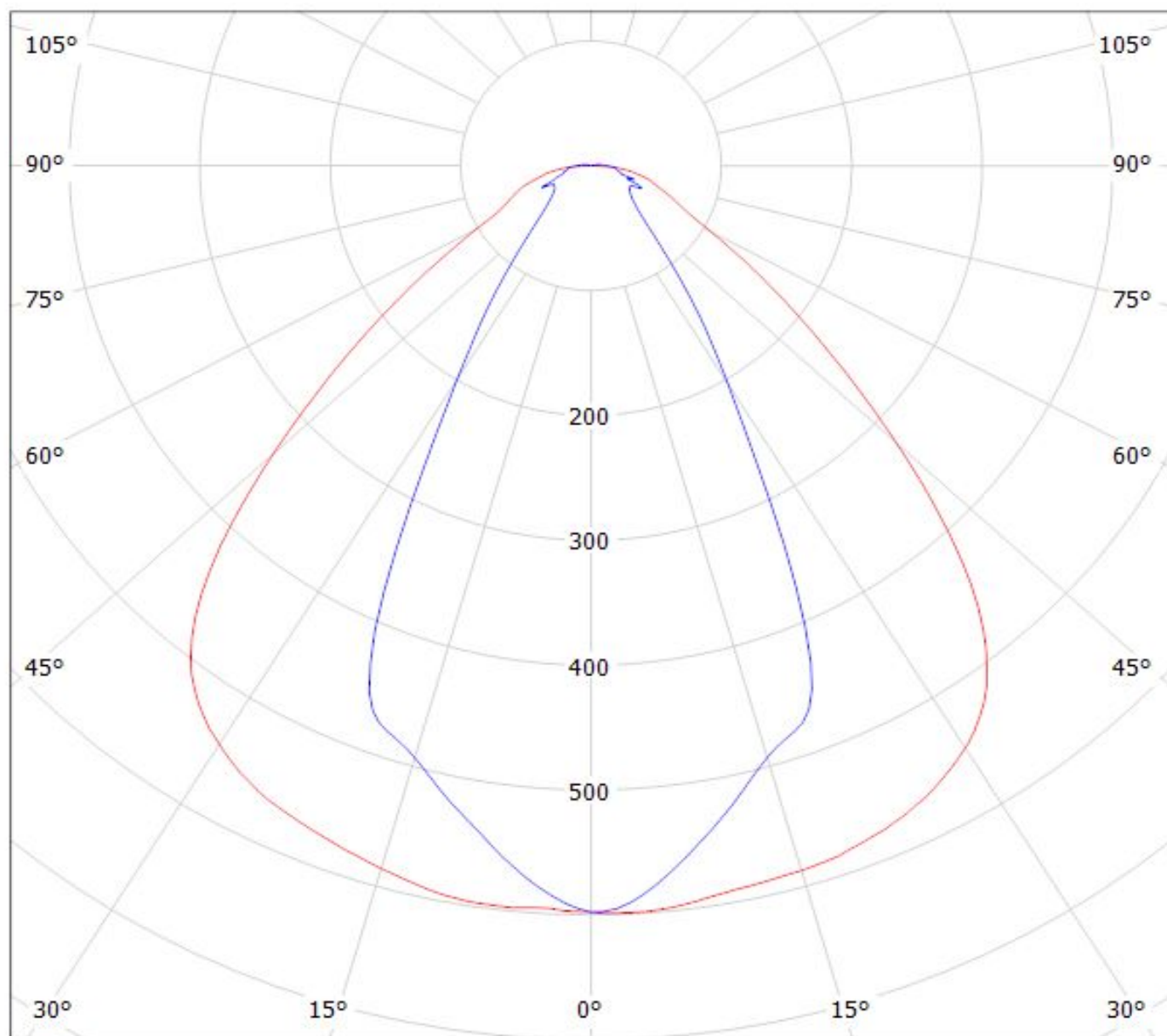

cd/klm

— C0 - C180

— C90 - C270

$\eta = 85\%$

Luminaire: Ledil F15524\_LINNEA-60\_(LT-S562H)

Lamps: 1 x Samsung\_LT-S562H\_(LM561B+)\_2286.62lm@300mA\_P=14.4W\_I=0.30A

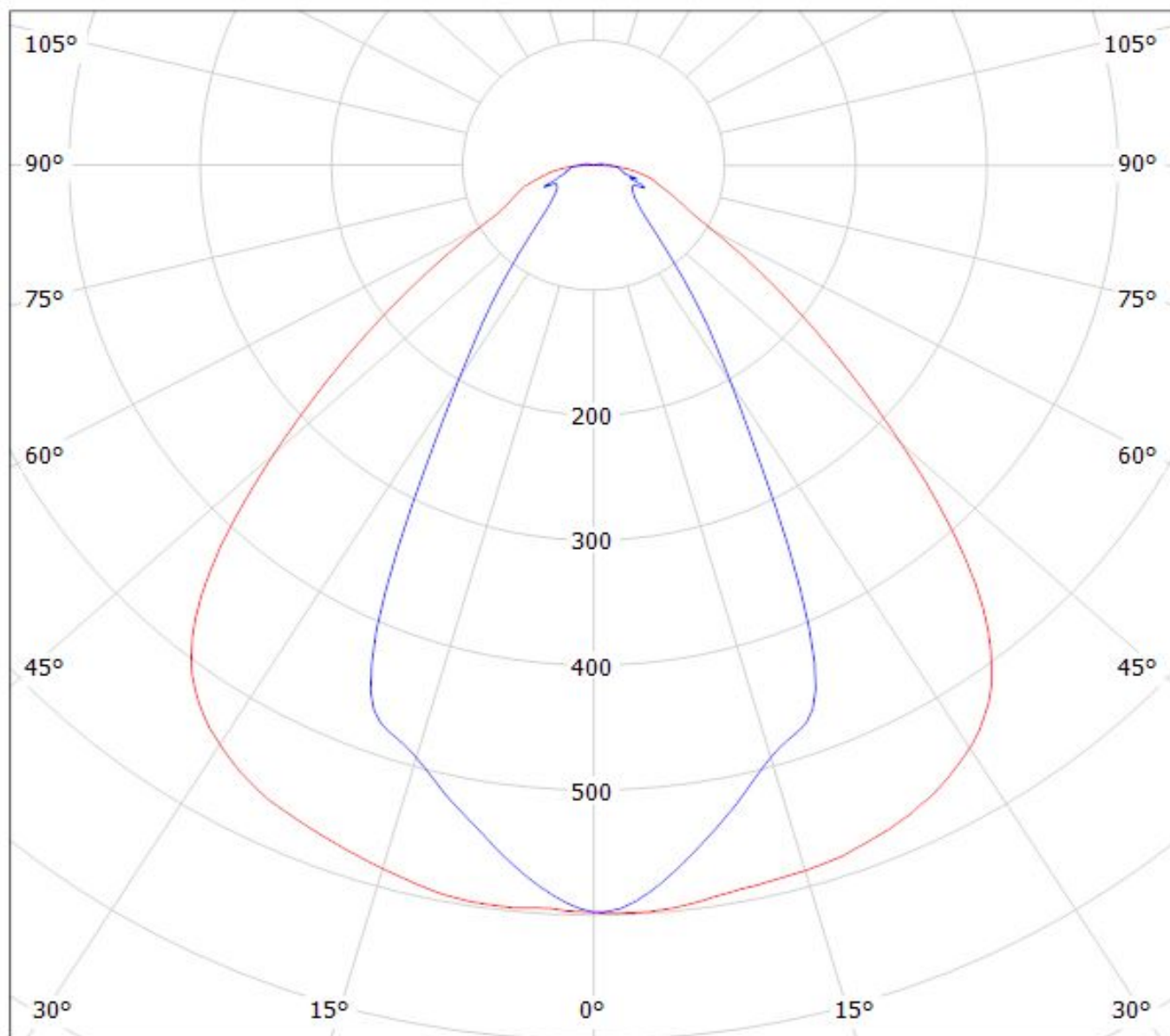

cd/klm

— C0 - C180

— C90 - C270

$\eta = 85\%$

Luminaire: Ledil F15524\_LINNEA-60\_(LT-Q282B)

Lamps: 1 x Samsung\_LT-Q282B\_(LM301B\_SI-B8T053280EU)\_943.526lm@180mA\_P=4.99618W\_U=27.805V

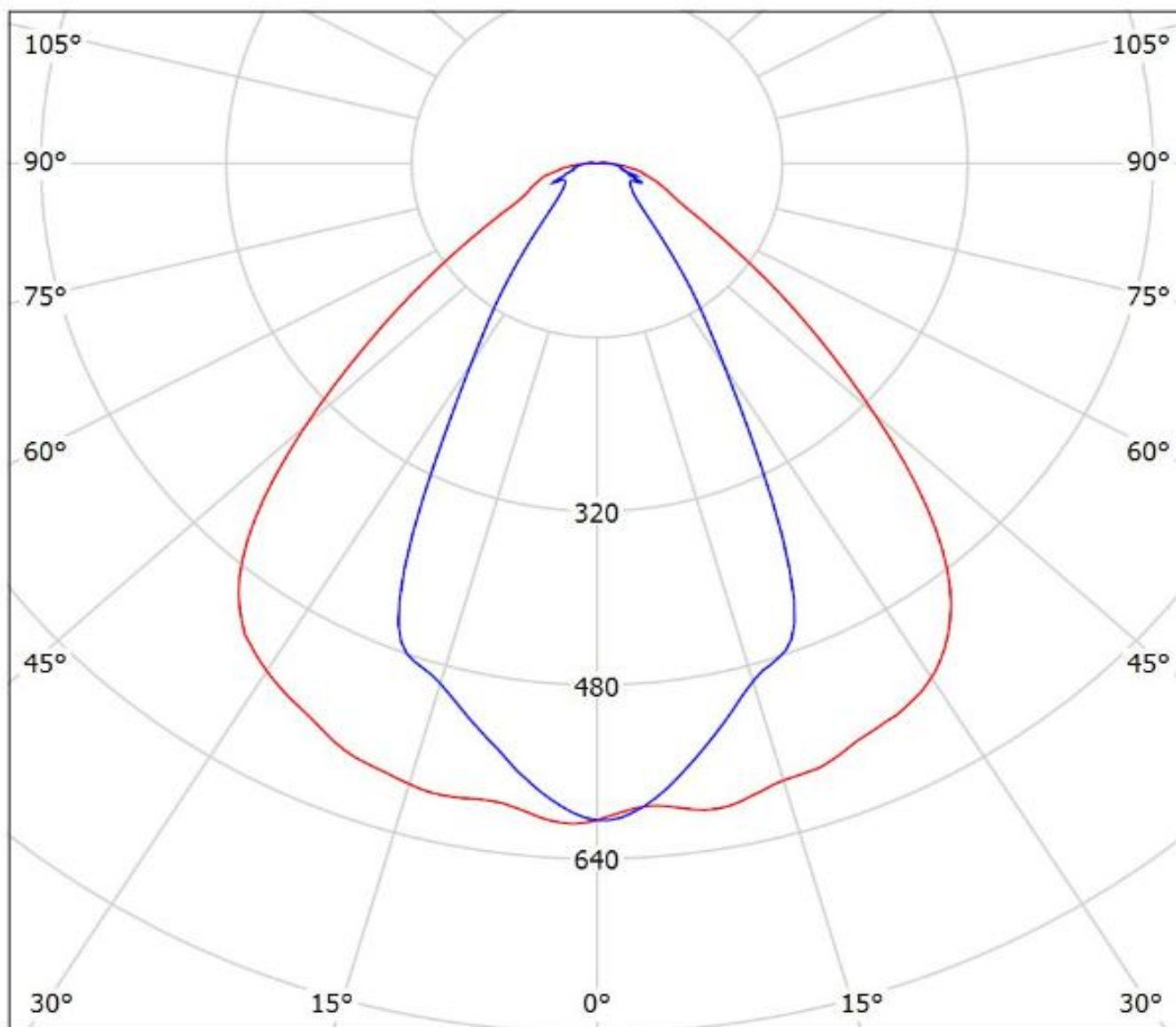

cd/klm

— C0 - C180 — C90 - C270

$\eta = 85\%$

Luminaire: LEDiL Oy F15524\_LINNEA-60\_(Seoul\_semi\_5630D)  
Lamps: 1 x Seoul\_Semi\_5630D\_932.657lm@250mA\_P=5.68145W\_I=0.250A

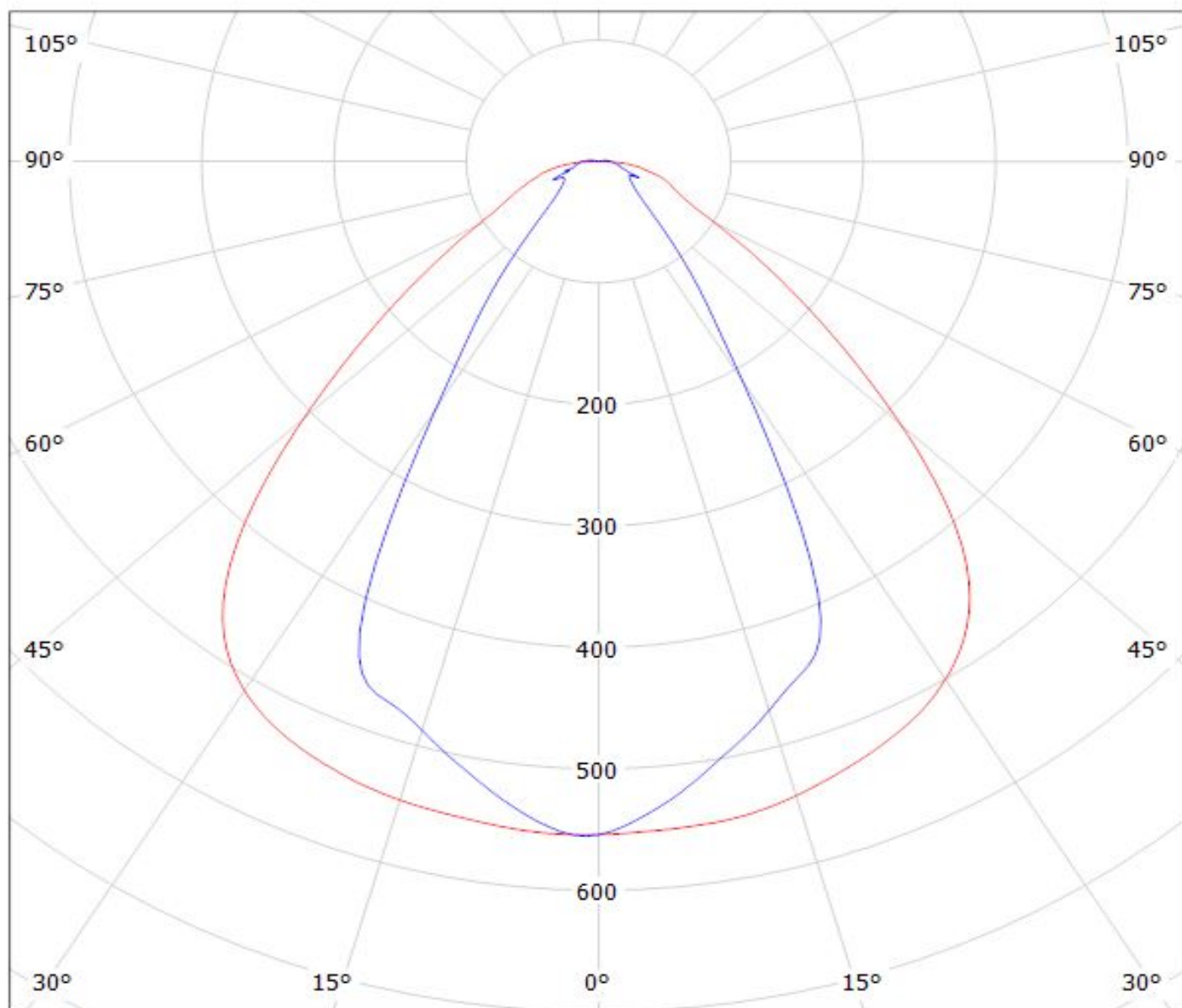

cd/klm

— C0 - C180    — C90 - C270

$\eta = 84\%$

Luminaire: Ledil F15524\_LINNEA-60\_(SunLike\_3030)

Lamps: 1 x SEOUL\_SunLike\_3030\_(STW9C2PB-S)\_2\_240.649lm@0.65mA\_P=2.30531W\_U=35.538V

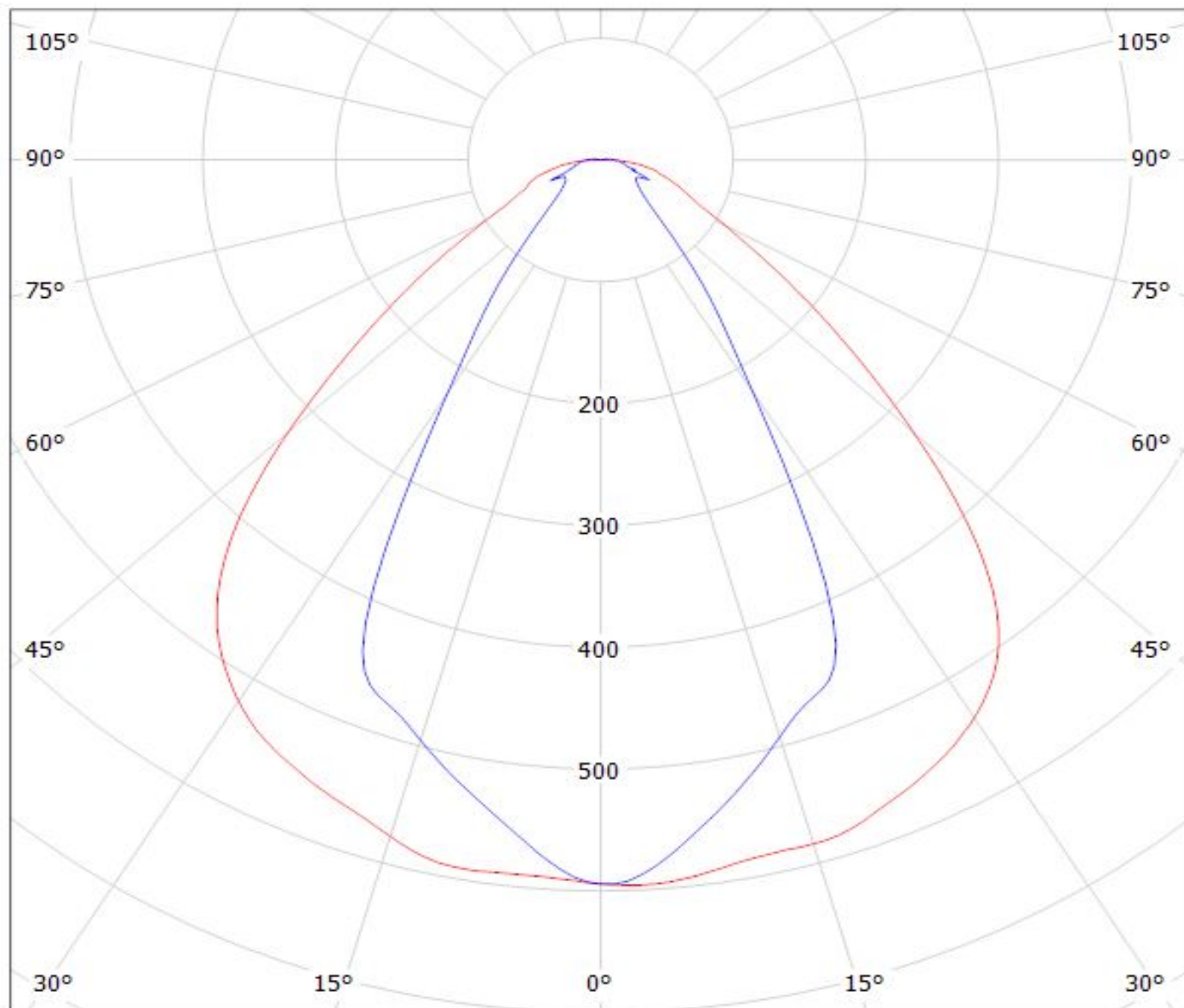

cd/klm

— C0 - C180

— C90 - C270

$\eta = 86\%$

Luminaire: LEDiL Oy F15524\_LINNEA-60\_(LLE\_G4\_24x280mm\_650lm\_840\_2T\_ADV)

Lamps: 1 x

Tridonic\_LLE\_G4\_24x280mm\_650lm\_840\_2T\_ADV\_485.133lm@250mA\_CCT=4000K\_P=2.81774W\_U=11.279V

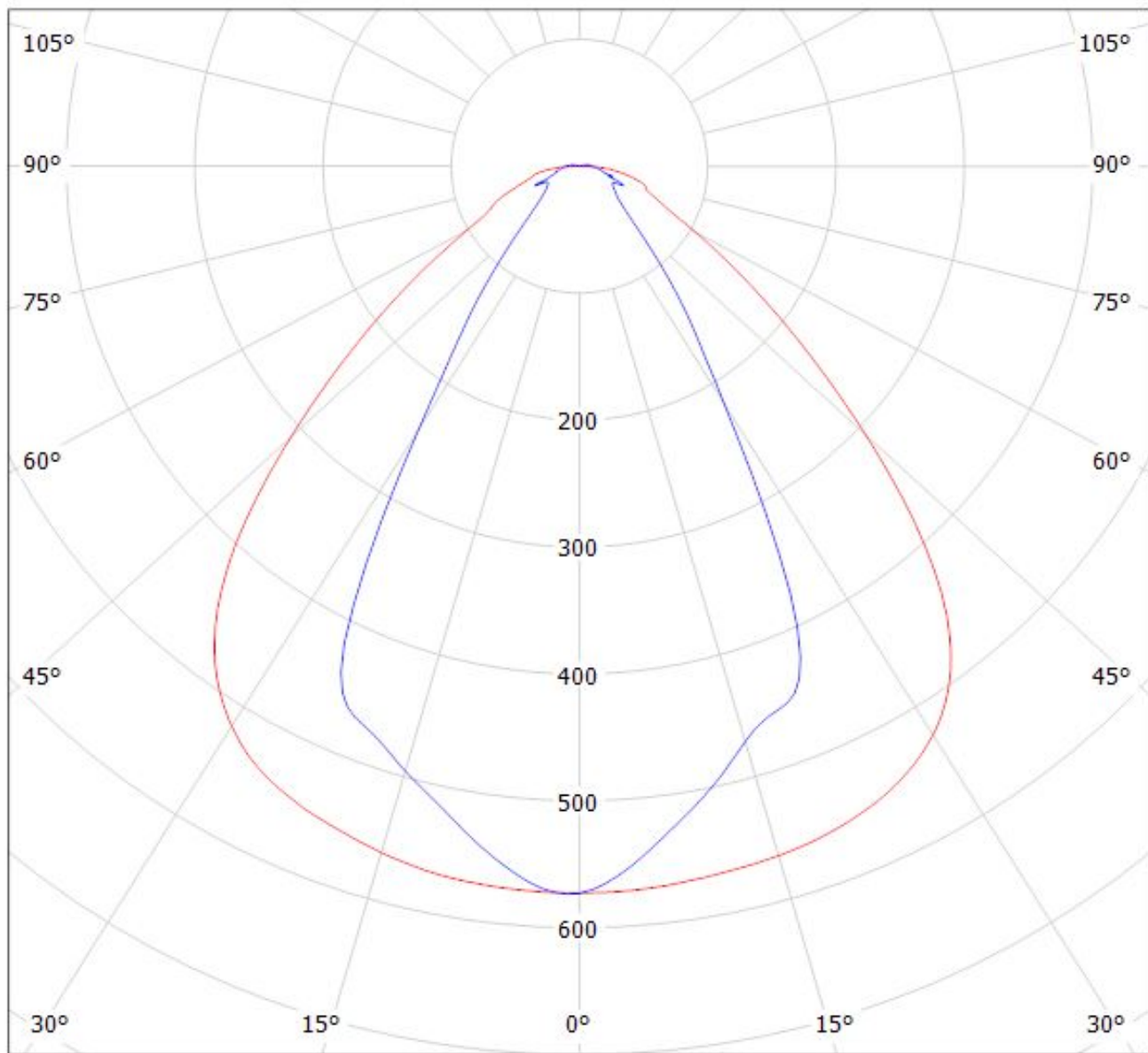

cd/klm

— C0 - C180 — C90 - C270

$\eta = 85\%$

Luminaire: Ledil F15524\_LINNEA-60\_(LLE\_G4\_24x280mm\_1250lm\_840\_4T\_ADV)  
Lamps: 1 x Tridonic\_(LLE\_G4\_24x280mm\_1250lm\_840\_4T\_ADV)  
\_971.78lm@250mA\_CCT=4000K\_P=5.6355W\_U=22.5500V

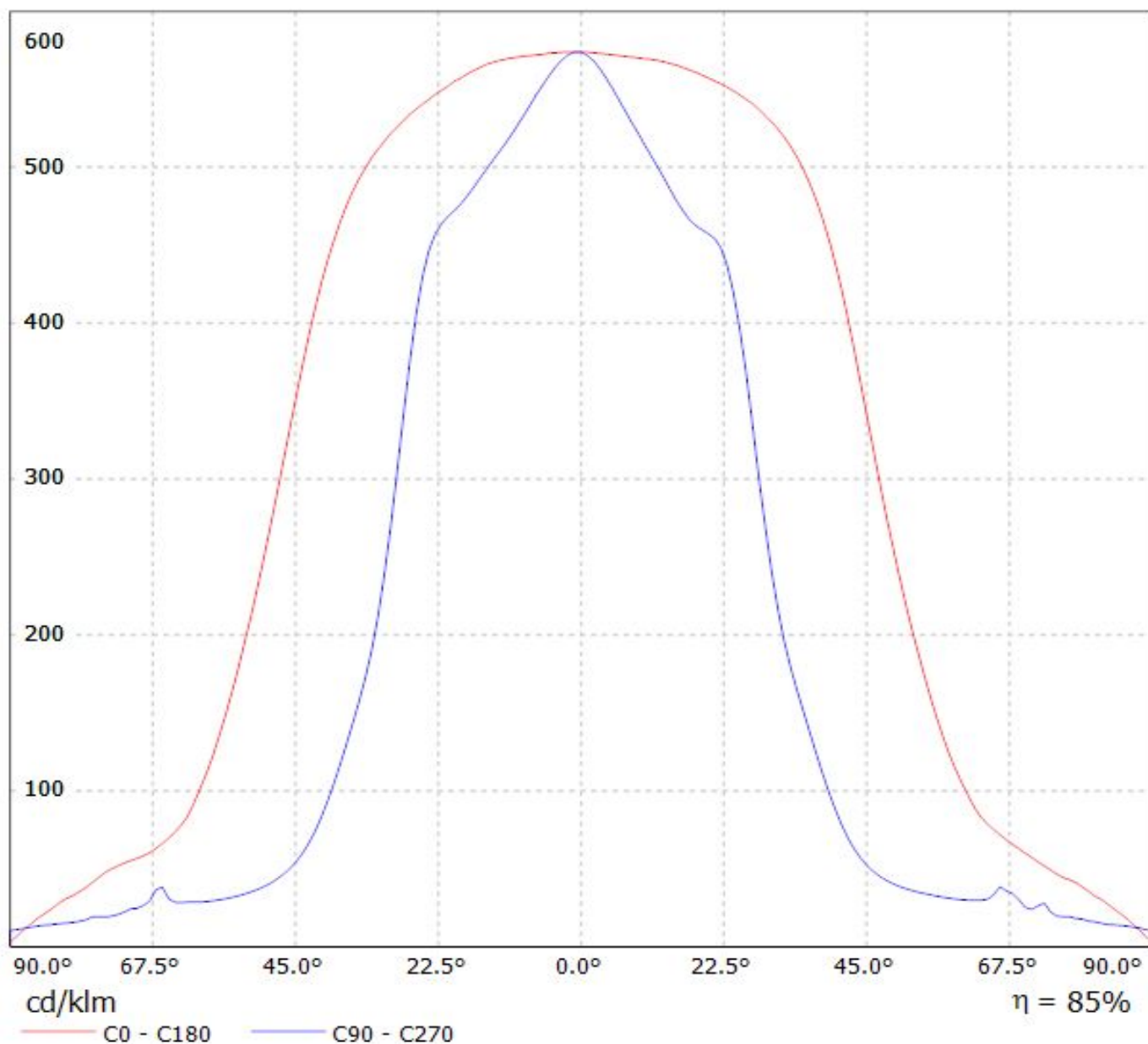

Luminaire: Ledil Oy F15524\_LINNEA-60\_(LLE G4 24x280mm 2000lm ADV)\_SIMULATED  
Lamps: 1 x Tridonic LLE G4 24x280mm 2000lm ADV

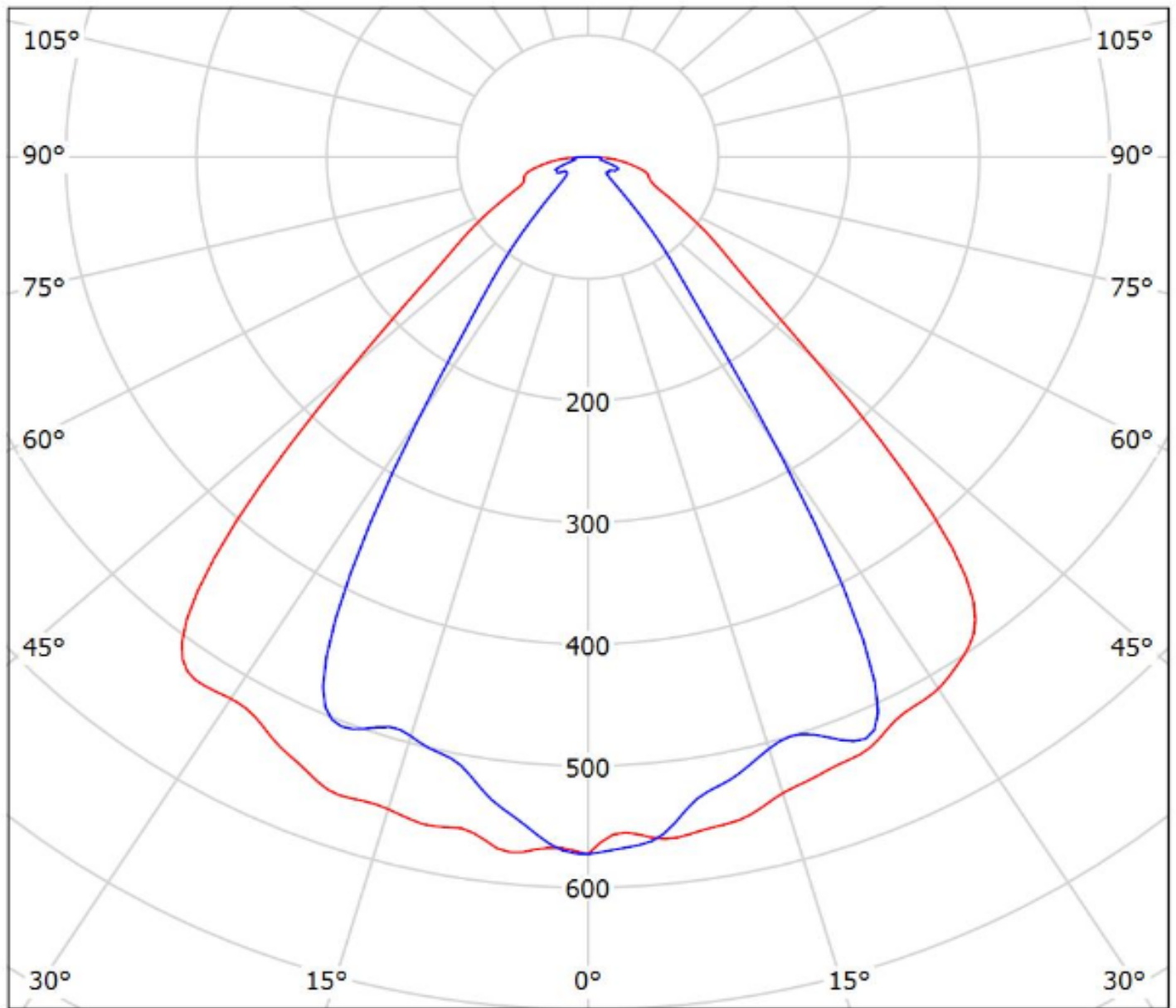

cd/klm

— C0 - C180 — C90 - C270

$\eta = 84\%$

Luminaire: LEDiL Oy F15524\_LINNEA-60\_(CALOSNU405-M7W1)

Lamps: 1 x ARRANT\_LIGHT\_CALOSNU405-M7W1\_494.124lm@250mA\_CCT=4000K\_P=2.74955W\_U=11.007V

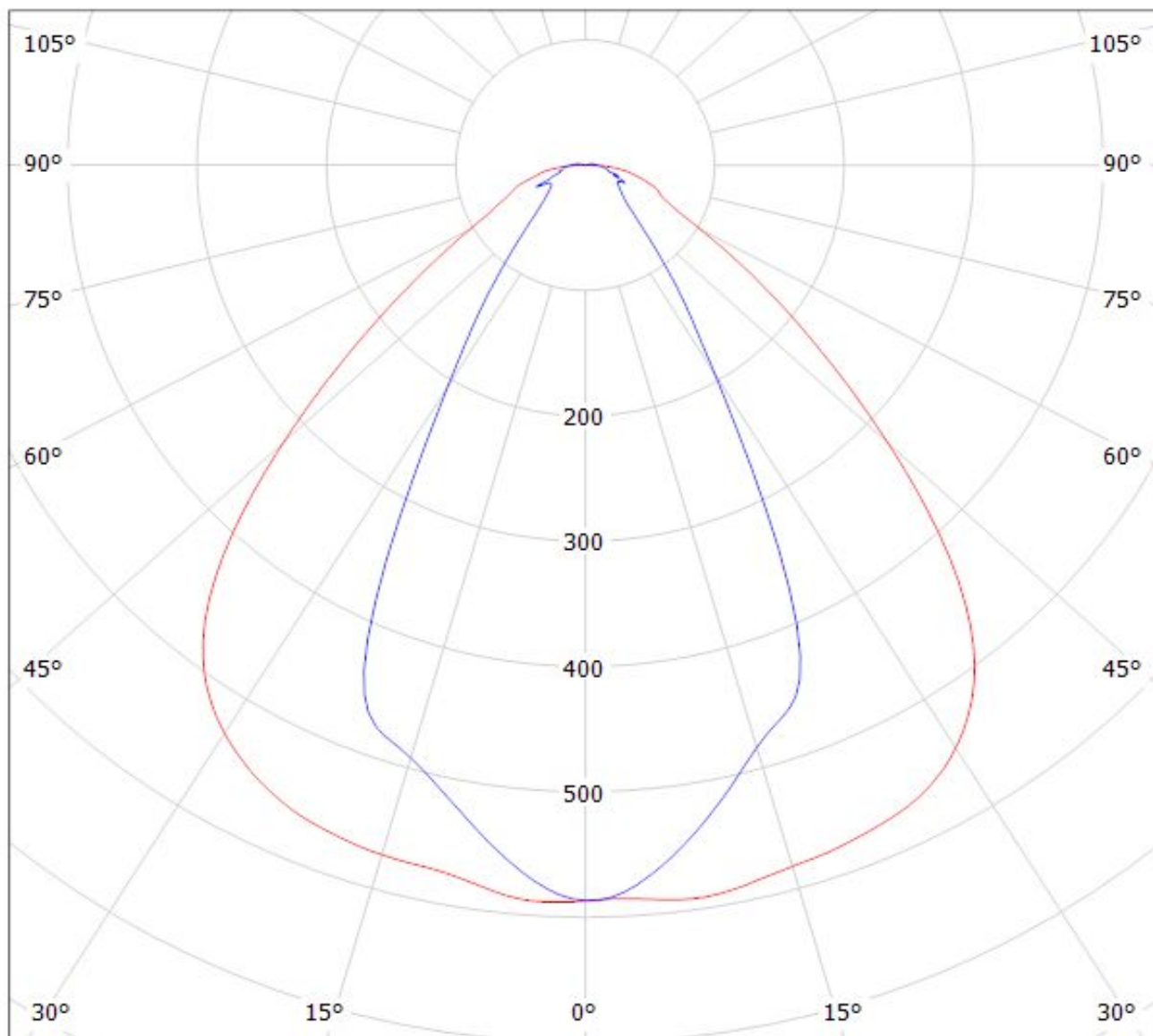

cd/klm

— C0 - C180    — C90 - C270

$\eta = 84\%$

Luminaire: Ledil F15524\_LINNEA-60\_(CALOSNU410-M7W1)

Lamps: 1 x ARRANT\_LIGHT\_CALOSNU410-M7W1\_499.378lm@250mA\_CCT=4000K\_P=2.70242W\_U=10.814V

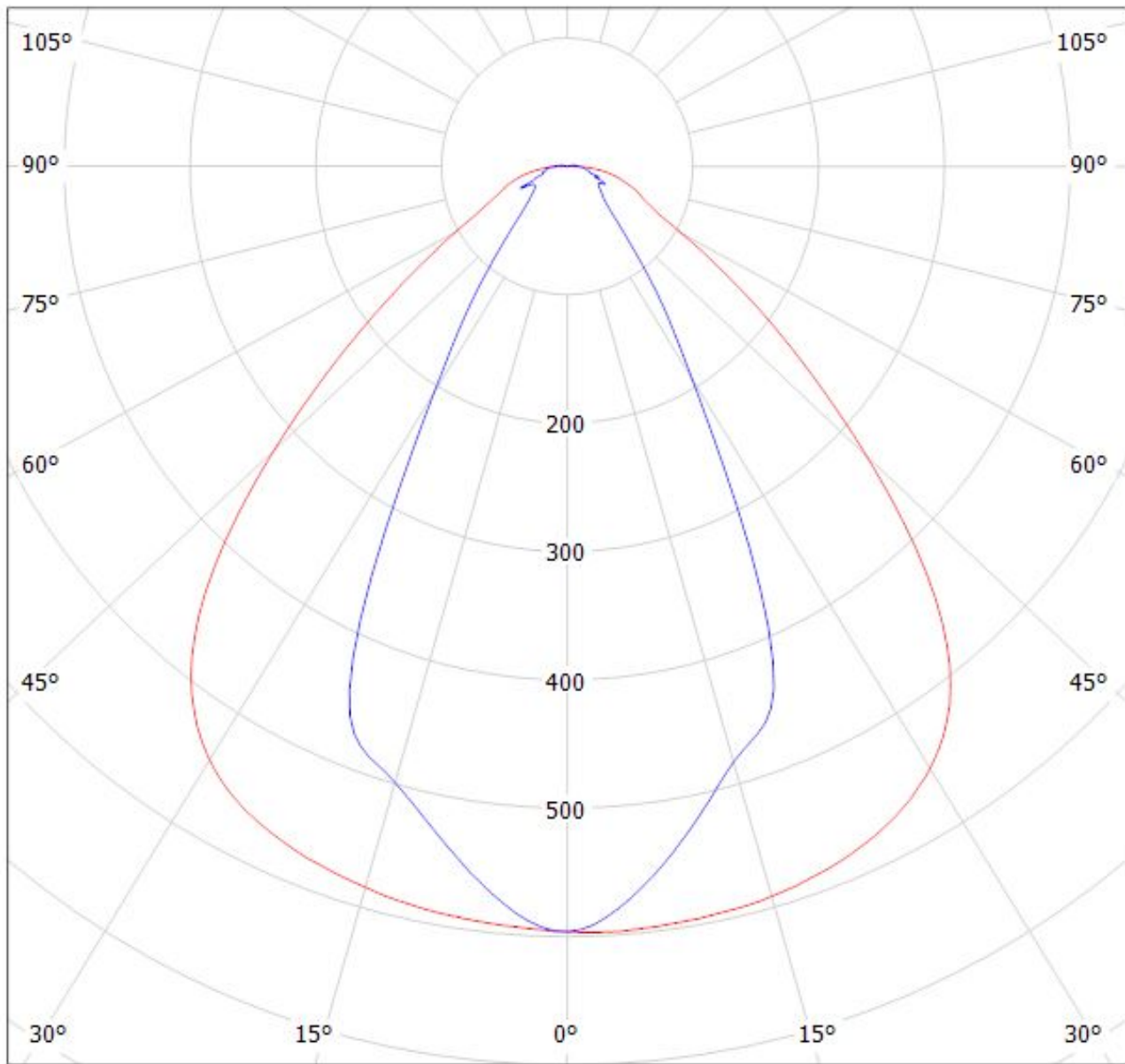

cd/klm

— C0 - C180    — C90 - C270

$\eta = 84\%$

**NOTE: The typical divergence will be changed by different color, chip size and chip position tolerance. The typical total divergence is the full angle measured where the luminous intensity is half of the peak value.**